



CFF FLUID CONTROL LIMITED

Corporate Identity Number is U28990MH2012PLC227023

REGISTERED OFFICE	CORPORATE OFFICE	CONTACT PERSON	EMAIL AND TELEPHONE	WEBSITE
Plot No 01, Survey No 96, Kumbhivli Madap Khopoli, Khalapur, Raigarh - 410203	503, Delphi, A Wing, Orchard Avenue, Hiranandani Business Park, Powai, Mumbai-400076	Sonika Mehta <i>Company Secretary and Compliance Officer</i>	Email: compliance@cffdefensys.com Telephone: +91-2246086806	www.cffdefensys.com

PROMOTERS OF OUR COMPANY: SUNIL MENON AND GAUTAM MAKKER

DETAILS OF THE ISSUE

TYPE	FRESH ISSUE SIZE	OFS SIZE (BY NO. OF SHARES OR BY AMOUNT IN ₹)	TOTAL ISSUE SIZE	ELIGIBILITY
Fresh Issue	Upto 15,00,000 Equity Shares of ₹ 10 each aggregating Upto ₹ [●] lakhs	NA	Upto 15,00,000 Equity Shares of ₹ 10 each aggregating Upto ₹ [●] lakhs	The issue is being made in terms of Regulations 103, 104 of Chapter IV read with Regulation 281 of Chapter IX of the SEBI (ICDR) Regulations, 2018 as amended. For details in relation to share reservation among QIBs, Non-Institutional Bidders and Retail Individual Bidder, see “Issue Structure” beginning on page 202 of this Draft Prospectus.

DETAILS OF OFFER FOR SALE, SELLING SHAREHOLDERS AND THEIR AVERAGE COST OF ACQUISITION – NOT APPLICABLE AS THIS IS A FRESH ISSUE OF EQUITY SHARES

GENERAL RISKS

Investments in equity and equity-related securities involve a degree of risk and investors should not invest any funds in the Issue unless they can afford to take the risk of losing their investment. Investors are advised to read the risk factors carefully before taking an investment decision in the Issue. For taking an investment decision, investors must rely on their own examination of our Company and the Issue, including the risks involved. The Equity Shares in the Issue have not been recommended or approved by the Securities and Exchange Board of India (“SEBI”), nor does SEBI guarantee the accuracy or adequacy of the contents of this Draft Prospectus. Specific attention of the investors is invited to “Risk Factors” on page 20 of this Draft Prospectus.

ISSUER’S ABSOLUTE RESPONSIBILITY



Our Company, having made all reasonable inquiries, accepts responsibility for and confirms that this Draft Prospectus contains all information with regard to our Company and the Issue, which is material in the context of the Issue, that the information contained in this Draft Prospectus is true and correct in all material aspects and is not misleading in any material respect, that the opinions and intentions expressed herein are honestly held and that there are no other facts, the omission of which makes this Draft Prospectus as a whole or any of such information or the expression of any such opinions or intentions misleading in any material respect.

LISTING

The Equity Shares issued through the Draft Prospectus are proposed to be listed on the SME Platform of BSE Limited (“BSE SME”) in terms of the Chapter IV & IX of the SEBI (ICDR) Regulations, 2018 as amended from time to time. Our Company has received an “In-Principle” approval letter dated [●] from BSE Limited (“BSE”) for using its name in this offer document for listing our shares on the SME Platform of BSE Limited. For the purpose of this Issue, the Designated Stock Exchange will be BSE Limited (“BSE”).

LEAD MANAGER TO THE ISSUE

REGISTRAR TO THE ISSUE

 ARYAMAN FINANCIAL SERVICES LTD	 CAMEO
ARYAMAN FINANCIAL SERVICES LIMITED 60, Khatau Building, Ground Floor, Alkesh Dinesh Modi Marg, Opp. P. J. Towers (BSE Building), Fort, Mumbai – 400 001 Tel No.: +91 22 6216 6999 Email: ipo@afsl.co.in Website: www.afsl.co.in Investor Grievance Email: feedback@afsl.co.in Contact Person: Vatsal Ganatra/ Harsha Lohia SEBI Registration No. INM000011344	CAMEO CORPORATE SERVICES LIMITED Subramanian Building, No. 1, Club House Road, Chennai – 600 002. Tel.: +91 - 44 – 40020700 (5 Lines) E-mail: priya@cameoindia.com Investor Grievance Email: investor@cameodina.com Website: www.cameoindia.com Contact Person: Ms. K. Sreepriya SEBI Registration. No.: INR 000003753
ISSUE OPENS ON	ISSUE CLOSES ON
[●]	[●]



CFF FLUID CONTROL LIMITED

Our Company was incorporated as Flash Forge Fluid Control Private Limited on February 16, 2012 under the Companies Act, 1956 with the Registrar of Companies, Mumbai, Maharashtra bearing Registration number 227023. The name of our company was changed to CFF Fluid Control Private Limited vide Special resolution dated September 21, 2012. The fresh certificate of incorporation consequent of name change was issued on October 19, 2012 by the Registrar of Companies, Mumbai, Maharashtra. Further the status of the Company was changed to Public limited and the name of our Company was changed to CFF Fluid Control Limited vide Special Resolution dated September 05, 2022. The fresh certificate of incorporation consequent to conversion was issued on September 15, 2022 by the Registrar of Companies, Mumbai, Maharashtra. The Corporate Identification Number of our Company is U28990MH2012PLC227023. For further details pertaining to the change of name of our Company and the change in Registered Office, please refer the chapter “History and Certain Corporate Matters” on page no. 116 of this Draft Prospectus.

Registered Office: Plot No 01, Survey No 96, Kumbhivli Madap Khopoli, Khalapur, Raigarh-410203
Corporate Office: 503, Delphi, A Wing, Orchard Avenue, Hiranandani Business Park, Powai, Mumbai-400076
Tel No.: +91 - 22 - 40021599. **Email:** compliance@cffdefensys.com **Website:** www.cffdefensys.com
Contact Person: Sonika Mehta, Company Secretary and Compliance Officer.

Our Promoters: Sunil Menon and Gautam Makker

THE ISSUE

FURTHER PUBLIC OFFER OF 15,00,000 EQUITY SHARES OF ₹ 10 EACH (“EQUITY SHARES”) OF CFF FLUID CONTROL LIMITED (“CFF” OR THE “COMPANY”) FOR CASH AT A PRICE OF ₹ [•] PER SHARE (THE “ISSUE PRICE”), AGGREGATING TO ₹ [•] LAKHS (“THE ISSUE”), OF WHICH [•] EQUITY SHARES OF ₹ 10 EACH WILL BE RESERVED FOR SUBSCRIPTION BY MARKET MAKER TO THE ISSUE (THE “MARKET MAKER RESERVATION PORTION”). THE ISSUE LESS MARKET MAKER RESERVATION PORTION I.E. ISSUE OF [•] EQUITY SHARES OF ₹ 10 EACH IS HEREINAFTER REFERRED TO AS THE “NET ISSUE”. THE ISSUE AND THE NET ISSUE WILL CONSTITUTE [•] % AND [•] %, RESPECTIVELY OF THE POST ISSUE PAID UP EQUITY SHARE CAPITAL OF THE COMPANY.

PROMOTERS OF OUR COMPANY: SUNIL MENON AND GAUTAM MAKKER

The Issue is being made through the Fixed Price Process in accordance with Regulation 281 read with Regulation 103(1) of the Securities and Exchange Board of India (Issue of Capital and Disclosure Requirements) Regulations, 2018, as amended (the “SEBI ICDR Regulations”), wherein a minimum 50% of the Net Issue is allocated for Retail Individual Applicants and the balance shall be offered to individual applicants other than Retail Individual Applicants and other investors including corporate bodies or institutions, QIBs and Non-Institutional Applicants. However, if the aggregate demand from the Retail Individual Applicants is less than 50%, then the balance Equity Shares in that portion will be added to the non-retail portion offered to the remaining investors including QIBs and NIIs and vice-versa subject to valid Applications being received from them at the Issue Price. Additionally, if the Retail Individual Applicants category is entitled to more than fifty per cent on proportionate basis, the Retail Individual Applicants shall be allocated that higher percentage. Specific attention of investors is invited to the chapter titled “Issue Information” on page no. 194 of this Draft Prospectus.

In terms of Regulation 256 of SEBI ICDR Regulations read with the SEBI Circular No. CIR/CFD/POLICYCELL/11/2015 dated November 10, 2015, and Unified Payments Interface (UPI) introduced vide SEBI Circular Ref: SEBI/HO/CFD/DIL2/CIR/P/2018/138 dated November 1, 2018 all the potential investors shall participate in the issue only through an Application Supported by Blocked Amount (“ASBA”) process providing details about the bank account which will be blocked by the Self Certified Syndicate Banks (“SCSBs”) for the same. Further, pursuant to SEBI Circular No. SEBI/HO/CFD/DCR2/CIR/P/2019/133 dated November 08, 2019, Retail Individual Investors applying in public issue may use either Application Supported by Blocked Amount (ASBA) process or UPI payment mechanism by providing UPI ID in the Application Form which is linked from Bank Account of the investor. (For details in this regard, specific attention is invited to “Issue Procedure” beginning on page no. 205 of this Draft Prospectus.)

GENERAL RISKS

Investment in equity and equity-related securities involve a degree of risk and investors should not invest any funds in the Issue unless they can afford to take the risk of losing their investment. Investors are advised to read the risk factors carefully before taking an investment decision in the Issue. For taking an investment decision, investors must rely on their own examination of our Company and the Issue, including the risks involved. The Equity Shares in the Issue have not been recommended or approved by the Securities and Exchange Board of India (“SEBI”), nor does SEBI guarantee the accuracy or adequacy of the contents of this Draft Prospectus. Specific attention of the investors is invited to “Risk Factors” beginning on page no. 20 of this Draft Prospectus.

COMPANY’S ABSOLUTE RESPONSIBILITY



Our Company, having made all reasonable inquiries, accepts responsibility for and confirms that this Draft Prospectus contains all information with regard to our Company and the Issue, which is material in the context of the Issue, that the information contained in this Draft Prospectus is true and correct in all material aspects and is not misleading in any material respect, that the opinions and intentions expressed herein are honestly held and that there are no other facts, the omission of which makes this Draft Prospectus as a whole or any of such information or the expression of any such opinions or intentions misleading in any material respect.

LISTING

The Equity Shares of our Company are already listed on the SME Platform of BSE Limited (“BSE SME”). Our Company has received an In-Principle Approval letter dated [•] from BSE Limited for using its name in this Offer Document for listing our shares on the SME Platform of BSE Limited. For the purpose of this Issue, the Designated Stock Exchange will be the BSE Limited (“BSE”).

LEAD MANAGER TO THE ISSUE

REGISTRAR TO THE ISSUE

 <p>ARYAMAN FINANCIAL SERVICES LIMITED 60, Khatau Building, Ground Floor, Alkesh Dinesh Modi Marg, Opp. P. J. Towers (BSE Building), Fort, Mumbai – 400 001 Tel No.: +91 22 6216 6999 Email: ipo@afsl.co.in Website: www.afsl.co.in Investor Grievance Email: feedback@afsl.co.in Contact Person: Vatsal Ganatra/ Harsha Lohia SEBI Registration No. INM000011344</p>	 <p>CAMEO CORPORATE SERVICES LIMITED Subramanian Building, No. 1, Club House Road, Chennai – 600 002. Tel.: +91 - 44 – 40020700 (5 Lines) E-mail: priya@cameoindia.com Investor Grievance Email: investor@cameodina.com Website: www.cameoindia.com Contact Person: Ms. K. Sreepriya SEBI Registration. No.: INR 000003753</p>
---	--

ISSUE OPENS ON

ISSUE CLOSES ON

[•]

[•]

Table of Contents

SECTION I – GENERAL	1
DEFINITIONS AND ABBREVIATIONS	1
CERTAIN CONVENTIONS AND PRESENTATION OF FINANCIAL	12
FORWARD-LOOKING STATEMENTS	14
SECTION II - SUMMARY OF ISSUE DOCUMENT	15
SECTION III- RISK FACTORS	20
SECTION IV: INTRODUCTION	41
THE ISSUE.....	41
SUMMARY OF FINANCIAL INFORMATION	42
GENERAL INFORMATION	46
CAPITAL STRUCTURE.....	53
SECTION V- PARTICULARS OF THE ISSUE	62
OBJECTS OF THE ISSUE	62
BASIS OF ISSUE PRICE	69
STATEMENT OF TAX BENEFITS.....	74
SECTION VI – ABOUT OUR COMPANY	77
INDUSTRY OVERVIEW	77
OUR BUSINESS	89
KEY REGULATIONS AND POLICIES.....	107
HISTORY AND CERTAIN CORPORATE MATTERS	116
OUR MANAGEMENT.....	120
OUR PROMOTER AND PROMOTER GROUP	133
OUR GROUP COMPANIES.....	137
DIVIDEND POLICY	139
SECTION VII- FINANCIAL INFORMATION	140
RESTATED FINANCIAL INFORMATION	140
OTHER FINANCIAL INFORMATION.....	158
MANAGEMENT DISCUSSION AND ANALYSIS OF FINANCIAL CONDITION AND RESULTS OF OPERATION	159
CAPITALISATION STATEMENT	169
FINANCIAL INDEBTEDENESS	170
STOCK MARKET DATA FOR EQUITY SHARES OF OUR COMPANY	171
SECTION VIII – LEGAL AND OTHER INFORMATION	173
OUTSTANDING LITIGATION AND MATERIAL DEVELOPMENTS	173
GOVERNMENT AND OTHER STATUTORY APPROVALS	177
SECTION IX – OTHER REGULATORY AND STATUTORY DISCLOSURES	180
SECTION X – ISSUE INFORMATION	194
TERMS OF THE ISSUE	194
ISSUE STRUCTURE	202
ISSUE PROCEDURE	205
RESTRICTIONS ON FOREIGN OWNERSHIP OF INDIAN SECURITIES	225
SECTION XI – MAIN PROVISIONS OF ARTICLES OF ASSOCIATION	228
SECTION XII – OTHER INFORMATION	242
MATERIAL CONTRACTS AND DOCUMENTS FOR INSPECTION	242
DECLARATION	244

SECTION I – GENERAL

DEFINITIONS AND ABBREVIATIONS

This Draft Prospectus uses certain definitions and abbreviations which, unless the context otherwise indicates or implies, shall have the same meaning as provided below. References to any legislation, act, regulation, rule, guideline or policy shall be to such legislation, act, regulation, rule, guideline or policy, as amended, supplemented or re-enacted from time to time and any reference to a statutory provision shall include any subordinate legislation made from time to time under that provision.

The words and expressions used in this Draft Prospectus but not defined herein shall have, to the extent applicable, the meaning ascribed to such terms under the Companies Act, the SEBI ICDR Regulations, the SCRA, the Depositories Act or the rules and regulations made there under. If there is any inconsistency between the definitions given below and the definitions contained in the General Information Document (defined hereinafter), the following definitions shall prevail.

GENERAL AND COMPANY RELATED TERMS

Term	Description
“Company”, “our Company”, “the Company”, “the Issuer”, “CFF Fluid Control Limited” or “CFF”	Unless the context otherwise indicates or implies refers to CFF Fluid Control Limited, a public limited company incorporated under the provisions of the Companies Act, 1956 with its registered office in the Plot No 01, Survey No 96, Kumbhivli Madap Khopoli, Khalapur, Raigarh-410203
Our Promoter(s)	Sunil Menon and Gautam Makker
Promoter Group	Companies, individuals and entities (other than companies) as defined under Regulation 2(1)(pp) of the SEBI (ICDR) Regulations, 2018 which is provided in the chapter titled “Our Promoters and Promoter Group”.

COMPANY RELATED TERMS

Term	Description
Articles / Articles of Association/AOA	Articles of Association of our Company.
Audit Committee	The committee of the Board of Directors constituted on November 04, 2022 as our Company’s Audit Committee in accordance with Section 177 of the Companies Act, 2013
Auditor / Statutory Auditor/ Auditor/	V. N. Purohit & Co., Chartered Accountants, being the current Statutory Auditors of our Company.
Bankers to the Company	Banker to our Company, namely Axis Bank Limited.
Board of Directors / Board/BOD	The Board of Directors of the Company unless otherwise specified.
Companies Act	The Companies Act, 1956/2013 as amended from time to time.
CIN	Corporate Identification Number of our Company i.e. U28990MH2012PLC227023
Chairman	The Chairman of our Board namely Gautam Makker.
Chief Financial Officer (CFO)	The Chief Financial officer of our Company, being Hitesh Birla.
Company Secretary and Compliance Officer (CS)	The Company Secretary and Compliance Officer of our Company, being Sonika Mehta
Corporate Office	The corporate office of our Company located at 503, Delphi, A Wing, Orchard Avenue, Hiranandani Business Park, Powai, Mumbai-400076
Depositories Act	The Depositories Act, 1996, as amended from time to time
DIN	Director Identification Number
Equity Shares	Equity Shares of our Company of Face Value of ₹ 10/- each unless otherwise specified in the context thereof
Equity Shareholders	Persons/ Entities holding Equity Shares of Our Company
Executive Director/	Executive Directors of our Company as on date of this Draft Prospectus and as described in

Term	Description
ED	“ <i>Our Management</i> ” on page 120
Group Companies	Companies with which there have been related party transactions, during the last three financial years, as covered under the applicable accounting standards and other companies as considered material by the Board in accordance with the Materiality Policy.
Independent Director	A non-executive & Independent Director as per the Companies Act, 2013 and the SEBI (Listing Obligations and Disclosure Requirements) Regulations, 2015.
Indian GAAP	Generally Accepted Accounting Principles in India
ISIN	International Securities Identification Number. In this case being INE0NJ001013.
Key Managerial Personnel / Key Managerial Employees	The officer vested with executive power and the officers at the level immediately below the Board of Directors as described in the section titled “ <i>Our Management</i> ” on page 120 of this Draft Prospectus.
Materiality Policy	The policy on identification of group companies, material creditors and material litigation, adopted by our Board on November 07, 2024 in accordance with the requirements of the SEBI ICDR Regulations.
MOA/Memorandum of Association	Memorandum of Association of our Company as amended from time to time.
Non-Residents	A person resident outside India, as defined under FEMA.
Nomination and Remuneration Committee	The Nomination and Remuneration Committee of our Board of Directors constituted in accordance with Companies Act, 2013. For details refer section titled “ <i>Our Management</i> ” on page 120 of this Draft Prospectus.
Non-Executive Director	A Director not being an Executive Director or an Independent Director.
NRI / Non Resident Indians	A person resident outside India, as defined under FEMA and who is a citizen of India or a Person of Indian Origin under Foreign Exchange Management Act, 1999
FPO Committee	FPO Committee of our Company as described in “ <i>Our Management</i> ” on page 120 of this Draft Prospectus.
Registered Office	The Registered Office of our Company situated at Plot No 01, Survey No 96, Kumbhivli Madap Khopoli, Khalapur, Raigarh-410203.
Restated Consolidated Financial Statements or Restated Consolidated Financial Information or Consolidated Financial Statements	The Restated Standalone Financial Information comprising the Standalone Consolidated Statement of Assets and Liabilities as at March 31, 2024, the Restated Consolidated Statement of Profit and Loss (including other comprehensive income), the Restated Standalone Cash Flow Statement for the year ended March 31, 2024, the Standalone Summary Statement of Significant Accounting Policies, and other explanatory information, prepared in terms of the Section 26 of Part I of Chapter III of the Companies Act, 2013, as amended; the Securities and Exchange Board of India (Issue of Capital and Disclosure Requirements) Regulations, 2018, as amended; and the Guidance Note on “Reports in Company Prospectuses (Revised 2019)” issued by the Institute of Chartered Accountants of India (“ICAI”), as amended from time to time. For further details, see “ <i>Restated Financial Information</i> ” on page 140 of this Draft Prospectus.
Restated Standalone Financial Statements or Restated Standalone Financial Information or Standalone Financial Statements	The Restated Standalone Financial Information comprising of the Restated Standalone Statement of Assets and Liabilities as at March 31, 2024, March 31, 2023 and March 31, 2022, the Restated Standalone Statements of Profit and Loss, the Restated Standalone Cash Flow Statement, each for the years ended March 31, 2024, March 31, 2023 and March 31, 2022, the Standalone Summary Statement of Significant Accounting Policies, and other explanatory information of the Company, prepared in terms of the Section 26 of Part I of Chapter III of the Companies Act, 2013, as amended; the Securities and Exchange Board of India (Issue of Capital and Disclosure Requirements) Regulations, 2018, as amended; and the Guidance Note on “Reports in Company Prospectuses (Revised 2019)” issued by the Institute of Chartered Accountants of India (“ICAI”), as amended from time to time. For further details, see “ <i>Restated Financial Information</i> ” on page 140 of this Draft Prospectus
Restated Financial Information	Restated financial information of our Company comprising of our Restated Standalone Financial Statements
ROC / Registrar of Companies	Registrar of Companies, Mumbai at Maharashtra situated at 100, Everest, Marine Drive, Mumbai 400 002.
Senior Management	Senior management of our Company in terms of Regulation 2(1) (bbbb) of the SEBI ICDR Regulations. For details, see “ <i>Our Management</i> ” on page 120 of this Draft Prospectus.
Shareholders	Shareholders of our Company, from time to time.

Term	Description
Stakeholders Relationship Committee	The Stakeholders Relationship Committee of our Board of Directors constituted in accordance with Section 178 of the Companies Act, 2013. For details refer section titled “Our Management” on page 120 of this Draft Prospectus.

ISSUE RELATED TERMS

Terms	Description
Abridged Prospectus	Abridged Prospectus means a memorandum containing such salient features of the Prospectus as may be specified by SEBI in this behalf
Acknowledgement Slip	The slip or document issued by the Designated Intermediary to an Applicant as proof of registration of the Application
Allotment	Issue of the Equity Shares pursuant to the Issue to the successful applicants
Allotment Advice	Note or advice or intimation of Allotment sent to the Bidders who have been allotted Equity Shares after the Basis of Allotment has been approved by the Designated Stock Exchanges
Allotment/Allot/Allotted	Unless the context otherwise requires, allotment of Equity Shares offered pursuant to the Issue pursuant to successful Bidders.
Allottee(s)	The successful applicant to whom the Equity Shares are being / have been issued
Application Supported by Blocked Amount / ASBA	An application, whether physical or electronic, used by applicants to make an application authorizing a SCSB to block the application amount in the ASBA Account maintained with the SCSB.
Application Form	The Form in terms of which the applicant shall apply for the Equity Shares of our Company
ASBA Account	An account maintained with the SCSB and specified in the application form submitted by ASBA applicant for blocking the amount mentioned in the application form.
ASBA Bid	A Bid made by ASBA Bidder
ASBA Circulars	Collectively, SEBI circular bearing reference number SEBI/CFD/DIL/ASBA/1/2009/30/12 dated December 30, 2009, SEBI circular bearing reference number CIR/CFD/DIL/1/2011 dated April 29, 2011 and the SEBI circular bearing reference number SEBI/HO/CFD/DIL2/CIR/P/2020/13 dated January 22, 2020 and SEBI circular bearing reference number SEBI/HO/CFD/SSEP/CIR/P/2022/66 dated May 19, 2022.
Bankers to the Issue	Banker to the Issue, Public Issue Bank, Refund Bank and Sponsor Bank, being [•]
Basis of Allotment	The basis on which equity shares will be allotted to successful applicants under the Issue and which is described in paragraph titled “Basis of allotment” under chapter titled “Issue Procedure” starting from page no. 205 of this Draft Prospectus.
Book Building Process	Book building process, as provided in Part A of Schedule XIII of the SEBI ICDR Regulations, in terms of which the Issue is being made.
LM / Lead Manager	Lead Manager to the Issue, in this case being Aryaman Financial Services Limited, SEBI Registered Category I Merchant Banker.
Broker Centers	Broker centers notified by the Stock Exchanges where investors can submit the Application Forms to a Registered Broker. The details of such Broker Centers, along with the names and contact details of the Registered Brokers are available on the websites of the Stock Exchange.
Business Day	Monday to Friday (except public holidays).
Cap Price	The higher end of the Price Band, subject to any revisions thereto, above which the Issue Price will not be finalized and above which no Bids will be accepted.
Cut-Off Price	The Issue Price, which shall be any price within the Price band as finalized by our Company in consultation with the LM. Only Retail Individual Bidders are entitled to Bid at the Cut off Price. QIBs (including Anchor Investor) and Non-Institutional Investors are not entitled to Bid at the Cut-off Price.
Client Id	Client Identification Number maintained with one of the Depositories in relation to demat account.
Collecting Depository Participants or CDPs	A depository participant as defined under the Depositories Act, 1996, registered with SEBI and who is eligible to procure bids at the Designated CDP Locations in terms of circular no. CIR/CFD/POLICYCELL/11/2015 dated November 10, 2015 issued by SEBI.
Controlling Branches of the SCSBs	Such branches of the SCSBs which coordinate with the LM, the Registrar to the Issue and the Stock Exchange.
Demographic Details	The demographic details of the Applicants such as their Address, PAN, name of the applicant father/husband, investor status, and occupation and Bank Account details.
Depository	A depository registered with SEBI under the SEBI (Depositories and Participants) Regulations, 2018.
Depository Participant	A Depository Participant as defined under the Depositories Act, 1996

Terms	Description
Designated Intermediaries/ Collecting Agent	The members of the Syndicate, sub-syndicate/agents, SCSBs, Registered Brokers, CDPs and RTAs, who are categorized to collect Application Forms from the Applicant, in relation to the Issue.
Designated Locations CDP	Such locations of the CDPs where bidder can submit the Bid cum Application Forms to Collecting Depository Participants. The details of such Designated CDP Locations, along with names and contact details of the Collecting Depository Participants eligible to accept Bid cum Application Forms are available on the website of the Stock Exchange.
Designated Date	The date on which amounts blocked by the SCSBs are transferred from the ASBA Accounts, as the case may be, to the Public Issue Account or the Refund Account, as appropriate, in terms of the Draft Prospectus, after finalization of the Basis of Allotment in consultation with the Designated Stock Exchange, following which the Board of Directors may Allot Equity Shares to successful Bidders in the Issue.
Designated Locations RTA	Such locations of the RTAs where bidder can submit the Bid cum Application Forms to RTAs. The details of such Designated RTA Locations, along with names and contact details of the RTAs eligible to accept Bid cum Application Forms are available on the website of the Stock Exchange.
Designated Branches SCSB	Such branches of the SCSBs which shall collect the ASBA Bid cum Application Form from the ASBA bidder and a list of which is available on the website of SEBI at http://www.sebi.gov.in/sebiweb/home/list/5/33/0/0/ Recognized-Intermediaries or at such other website as may be prescribed by SEBI from time to time.
Designated Exchange Stock	SME Platform of BSE Limited (“BSE SME”)
DP ID	Depository Participant’s Identity Number
Draft Prospectus	Draft Prospectus dated November 11, 2024, filed with SME Exchange of BSE Limited in accordance with Section 32 and Section 62 of the Companies Act, 2013 and SEBI (ICDR) Regulations.
Electronic Transfer of Funds	Refunds through ECS, NEFT, Direct Credit or RTGS as applicable.
Eligible Shareholders Equity	Holder(s) / Beneficial Owner of the Equity Shares of our Company as on the Record Date
Eligible FPI(s)	FPIs that are eligible to participate in this Offer in terms of applicable laws, other than individuals, corporate bodies and family offices.
Eligible NRI	NRIs from jurisdictions outside India where it is not unlawful to make an issue or invitation under the Issue and in relation to whom the Draft Prospectus constitutes an invitation to subscribe to the Equity Shares Allotted herein.
Eligible QFIs	QFIs from such jurisdictions outside India where it is not unlawful to make an Issue or invitation under the Issue and in relation to whom the Draft Prospectus constitutes an invitation to purchase the Equity Shares Issued thereby and who have opened demat accounts with SEBI registered qualified depository participants.
Escrow Account	The account(s) to be opened with the Escrow Collection Bank and in whose favour the Anchor Investors will transfer money through NACH/direct credit/ NEFT/ RTGS in respect of the Bid Amount when submitting a Bid.
Escrow Bank(s) Collection	Bank(s), which are clearing members and registered with SEBI as a banker to an issue under the SEBI BTI Regulations and with whom the Escrow Account will be opened, in this case being, ICICI Bank Limited
First/ Sole bidder	The bidder whose name appears first in the Bid cum Application Form or Revision Form.
Floor Price	The lower end of the Price Band, subject to any revision(s) thereto, not being less than the face value of Equity Shares, at or above which the Issue Price will be finalized and below which no Bids will be accepted.
Foreign Venture Capital Investors	Foreign Venture Capital Investors registered with SEBI under the Securities and Exchange Board of India (Foreign Venture Capital Investors) Regulations, 2000.
FPI / Foreign Portfolio Investor	A Foreign Portfolio Investor who has been registered under Securities and Exchange Board of India (Foreign Portfolio Investors) Regulations, 2014, provided that any FII or QFI who holds a valid certificate of registration shall be deemed to be a foreign portfolio investor till the expiry of the block of three years for which fees have been paid as per the SEBI (Foreign Institutional Investors) Regulations, 1995, as amended.
FPO Equity Shares	Further Public Offer of 15,00,000 equity shares of ₹[●] each, aggregating up to ₹ [●] lakhs.

Terms	Description
Fraudulent Borrower	Fraudulent borrower as defined under Regulation 2(1) (III) of the SEBI ICDR Regulations
Fugitive Economic Offender	An individual who is declared a fugitive economic offender under Section 12 of the Fugitive Economic Offenders Act, 2018
Further Public Offer / FPO	Further Public Offer of 15,00,000 equity shares of ₹[●] each, aggregating up to ₹ [●] lakhs.
Further Public Offer Period	The period between the FPO Opening Date and the FPO Closing Date, inclusive of both days and any extension thereof in accordance with the SEBI ICDR Regulations and the terms of this Draft Prospectus provided
General Information Document (GID)	The General Information Document for investing in public issues prepared and issued in accordance with the circulars (CIR/CFD/DIL/12/2013) dated October 23, 2013, Notified by SEBI and updated pursuant to the circular (CIR/CFD/POLICYCELL/11/2015) dated November 10, 2015 and (SEBI/HO/CFD/DIL/CIR/P/2016/26) dated January 21, 2016 and circular (SEBI/HO/CFD/DIL2/CIR/P/2018/138) dated November 1, 2018 notified by SEBI.
GIR Number	General Index Registry Number
Issue Agreement	Agreement dated November 05, 2024 entered amongst our Company and the Lead Manager , pursuant to which certain arrangements have been agreed to in relation to the Issue.
Issue Period	The periods between the Issue Opening Date and the Issue Closing Date inclusive of both days and during which prospective Applicants may submit their Bidding application.
Issue Price	The Price at which the Equity Shares are being Issued by our Company in consultation with the Lead Manager under this Draft Prospectus being ₹ [●] per equity share
Issue Proceeds	Proceeds to be raised by our Company through this Further Issue, for further details please refer chapter titled “ <i>Objects of the Issue</i> ” page 62 of this Draft Prospectus.
Listing Agreement	The Equity Listing Agreement to be signed between our Company and the BSE Limited.
Market Maker	The Market Maker to the Issue, in this case being [●].
Market Maker Reservation Portion	The reserved portion of [●] Equity Shares of ₹ 10 each at an Issue price of ₹ [●] each aggregating to ₹ [●] Lakhs to be subscribed by Market Maker in this Issue.
Market Making Agreement	The Market Making Agreement dated [●] between our Company, Lead Manager and Market Maker.
Mutual Funds	A mutual fund registered with SEBI under the SEBI (Mutual Funds) Regulations, 1996, as amended from time to time.
Mutual Fund Portion	5% of the Net QIB Portion, (other than anchor allocation), which shall be available for allocation to Mutual Funds only on a proportionate basis, subject to valid Bids being received at or above the Issue Price.
Net Issue	Further Public Offer of [●] equity shares of ₹[●] each, aggregating up to ₹ [●] lakhs.
Net QIB Portion	The portion of the QIB Portion less the number of Equity Shares Allocated to the Anchor Investors
Net Proceeds	The proceeds from the Issue less the Issue related expenses applicable to the Issue.
Non-Institutional Applicant / Investors	All Applicants, including FPIs which are individuals, corporate bodies and family offices, that are not QIBs or RIIs and who have Application for Equity Shares for an amount of more than ₹2.00 Lakhs (but not including NRIs other than Eligible NRIs)
Non-Institutional Bidders	Bidders that are not QIBs or Retail Individual Bidders and who have Bid for FPO Equity Shares offered in the FPO for an amount more than ₹ 2.00 lakhs
Non-Institutional Portion	The portion of the Issue being not less than 15% of the Net Issue consisting of [●]FPO Equity Shares which shall be available for allocation on a proportionate basis to Non-Institutional Bidders, subject to valid Bids being received at or above the Issue Price or through such other method of allocation as may be introduced under applicable law
NPCI	NPCI, a Reserve Bank of India (RBI) initiative, is an umbrella organization for all retail payments in India. It has been set up with the guidance and support of the Reserve Bank of India (RBI) and Indian Banks Association (IBA).
Person/Persons	Any individual, sole proprietorship, unincorporated association, unincorporated organization, body corporate, corporation, company, partnership, limited liability company, joint venture, or trust or any other entity or organization validly constituted and/or incorporated in the jurisdiction in which it exists and operates, as the context requires.
Prospectus	The Prospectus to be filed with the RoC in accordance with the Companies Act, 2013, and the SEBI ICDR Regulations containing, inter alia, the Issue Price that is determined at the end of the Fixed Price Process, the size of the Issue and certain other information, including any addenda or corrigenda thereto.
Public Issue Account Agreement	Agreement to be entered into by our Company, the Registrar to the Issue, the Lead Manager , and the Public Issue Bank/Banker to the Issue for collection of the Application Amounts.

Terms	Description
Public Issue Account	Account to be opened with the Banker to the Issue to receive monies from the SCSBs from the bank account of the ASBA bidder, on the Designated Date.
Public Issue Account Bank	The bank with whom the Public Issue Account shall be opened for collection of Bid Amounts from the Escrow Account and ASBA Accounts on the Designated Date, in this case being [●]
Qualified Institutional Buyers / QIBs	The qualified institutional buyers as defined under Regulation 2(1)(ss) of the SEBI ICDR Regulations.
QIB Category/ QIB Portion	The portion of the Net Issue (including the Anchor Investor Portion) being not more than [●]% of the Net Issue, consisting of [●] Equity Shares which were made available for allocation to QIBs (including Anchor Investors) on a proportionate basis, (in which allocation to Anchor Investor were made available on a discretionary basis, as determined by our Company in consultation with the LM), subject to valid Bids being received at or above the Issue Price.
Refund Bank(s) /Refund Banker(s)	Bank(s) which is / are clearing member(s) and registered with the SEBI as Bankers to the Issue at which the Refund Accounts will be opened in case listing of the Equity Shares does not occur, in this case being [●].
Refund Account	The ‘no-lien’ and ‘non-interest bearing’ account opened with the Refund Bank, from which refunds, if any, of the whole or part, of the Bid Amount to the Anchor Investors shall be made.
Registered Broker	Individuals or companies registered with SEBI as “Trading Members”(except Syndicate/ Sub-Syndicate Members) who hold valid membership of either BSE or BSE Limited having right to trade in stocks listed on Stock Exchanges ,through which investors can buy or sell securities listed on stock exchanges, a list of which is available on https://www.bseindia.com/
Registrar / Registrar to the Issue/ RTA	Registrar to the Issue being Cameo Corporate Services Limited.
Registrar Agreement	The registrar agreement dated November 05, 2024 entered into between our Company and the Registrar to the Issue in relation to the responsibilities and obligations of the Registrar to the Issue pertaining to the Issue.
Regulations	Unless the context specifies something else, this means the SEBI (Issue of Capital and Disclosure Requirements) Regulations, 2018.
Resident Indian	A person resident in India, as defined under FEMA.
Retail Individual Investors/(RII)	Individual investors (including HUFs applying through their Karta and Eligible NRI Bidders) who applies or bids for the Equity Shares of a value of not more than ₹ 2,00,000.
Revision Form	The form used by the bidders to modify the quantity of Equity Shares or the bid Amount in any of their Bid cum Application Forms or any previous Revision Form(s)
SCSB	The banks registered with SEBI, which offer services, (i) in relation to ASBA, where the Application Amount will be blocked by authorising an SCSB, a list of which is available on the website of SEBI at www.sebi.gov.in/sebiweb/other/OtherAction.do?doRecognisedFpi=yes&intmId=34 and updated from time to time and at such other websites as may be prescribed by SEBI from time to time, (ii) in relation to UPI applicants using the UPI Mechanism, a list of which is available on the website of SEBI at https://sebi.gov.in/sebiweb/other/OtherAction.do?doRecognisedFpi=yes&intmId=40 or such other website as updated from time to time. Applications through UPI in the Issue can be made only through the SCSBs mobile applications (apps) whose name appears on the SEBI website. A list of SCSBs and mobile application, which, are live for applying in public issues using UPI Mechanism is appearing in the “list of mobile applications for using UPI in public issues” displayed on the SEBI website. The said list shall be updated on the SEBI website.
Specified Locations	Bidding Centres where the Syndicate shall accept ASBA Forms from the Bidders, a list of which is available on http://www.sebi.gov.in/sebiweb/other/OtherAction.do?doRecognised=ys and updated from time to time.
Sponsor Bank	The Banker to the Issue registered with SEBI and appointed by our Company to act as a conduit between the Stock Exchanges and the NPCI in order to push the mandate collect requests and / or payment instructions of the Retail Individual Bidders into the UPI and carry out other responsibilities, in terms of the UPI Circulars.
Systemically Important Non-Banking Financial Company	Systemically important non-banking financial company as defined under Regulation 2(1)(iii) of the SEBI ICDR Regulations
Transaction Registration Slip/ TRS	The slip or document issued by a member of the Syndicate or an SCSB (only on demand), as the case may be, to the bidders, as proof of registration of the bid.
Underwriter	The Underwriter to the Issue, in this case being [●].

Terms	Description
Underwriting Agreement	The Agreement dated [●], entered into between the Underwriter and our Company
UPI	Unified payment Interface, which is an instant payment mechanism, developed by NPCI.
UPI Circular	Circular no. SEBI/HO/CFD/DIL2/CIR/P/2018/138 dated November 1, 2018 issued by SEBI as amended or modified by SEBI from time to time, including circular no. SEBI/HO/CFD/DIL2/CIR/P/2019/50 dated April 3, 2019, circular no. SEBI/HO/CFD/DIL2/CIR/P/2019/76 dated June 28, 2019, circular no. SEBI/HO/CFD/DIL2/CIR/P/2019/85 dated July 26, 2019, circular no. SEBI/HO/CFD/DIL2/CIR/P/2020/50 dated March 30, 2020, circular no. SEBI/HO/CFD/DIL2/CIR/P/2021/2480/1/M dated March 16, 2021, circular no. SEBI/HO/CFD/DIL2/P/CIR/2021/570 dated June 2, 2021, the circular no. SEBI/HO/CFD/DIL2/CIR/P/2022/45 dated April 5, 2022, the circular no. SEBI/HO/CFD/DIL2/CIR/P/2022/51 dated April 20, 2022, the circular no. SEBI/HO/CFD/DIL2/P/CIR/2022/75 dated May 30, 2022, SEBI master circular no. SEBI/HO/CFD/PoD-2/P/CIR/2023/00094 dated June 21, 2023, SEBI circular no. SEBI/HO/CFD/TPD1/CIR/P/2023/140 dated August 9, 2023, and any other circulars issued by SEBI or any other governmental authority in relation thereto from time to time
UPI ID	ID created on UPI for single-window mobile payment system developed by the NPCI.
UPI Mandate Request	A request (intimating the Retail Individual Bidder by way of a notification on the Mobile App and by way of a SMS directing the Retail Individual Bidder to such Mobile App) to the Retail Individual Bidder initiated by the Sponsor Bank to authorize blocking of funds on the Mobile App equivalent to Bid Amount and Subsequent debit of funds in case of Allotment.
UPI Mechanism	The bidding mechanism that may be used by a RII to make a Bid in the Issue in accordance with the UPI Circulars.
UPI PIN	Password to authenticate UPI transactions.
Working Days	In terms of Regulation 2(1)(mmm) of SEBI ICDR Regulations, working day means all days on which commercial banks in Mumbai are open for business. Further, in respect of Issue Period, working day means all days, excluding Saturdays, Sundays and public holidays, on which commercial banks in Mumbai are open for business. Furthermore, the time period between the Issue Closing Date and the listing of Equity Shares on NSE, working day means all trading days of NSE, excluding Sundays and bank holidays, as per circulars issued by SEBI

CONVENTIONAL AND GENERAL TERMS / ABBREVIATIONS

Term	Description
“₹” or “Rs.” or “Rupees” or “INR”	Indian Rupee
“Consolidated FDI Policy” or “FDI Policy”	Consolidated Foreign Direct Investment Policy notified by DPIIT through notification issued by DPIIT, effective from October 15, 2020
“Financial Year” or “Fiscal Year” or “FY”	Period of 12 months ending March 31 of that particular year
“OCBs” or “Overseas Corporate Body”	A company, partnership, society or other corporate body owned directly or indirectly to the extent of at least 60% by NRIs including overseas trusts, in which not less than 60% of beneficial interest is irrevocably held by NRIs directly or indirectly and which was in existence on October 3, 2003 and immediately before such date had taken benefits under the general permission granted to OCBs under FEMA
A/c	Account
AGM	Annual General Meeting
AIF	Alternative Investment Fund, as defined and registered with SEBI under the Securities and Exchange Board of India (Alternative Investment Funds) Regulations, 2012, as amended
AS	Accounting Standards issued by the Institute of Chartered Accountants of India
CAGR	Compounded Annual Growth Rate
CAN	Confirmation Allocation Note
Category I AIF	AIFs who are registered as “Category I Alternative Investment Funds” under the SEBI AIF Regulations
Category I FPIs	FPIs who are registered as “Category I foreign portfolio investors” under the SEBI FPI

Term	Description
	Regulations
Category II AIF	AIFs who are registered as “Category II Alternative Investment Funds” under the SEBI AIF Regulations
Category II FPIs	FPIs who are registered as “Category II foreign portfolio investors” under the SEBI FPI Regulations
Category III AIF	AIFs who are registered as “Category III Alternative Investment Funds” under the SEBI AIF Regulations
CBDT	Central Board of Direct Taxes, Government of India
CDSL	Central Depository Services (India) Limited
Central Government	Central Government of India
CFO	Chief Financial Officer
CIN	Corporate Identification Number
CIT	Commissioner of Income Tax
CLRA	Contract Labour (Regulation and Abolition) Act, 1970
Companies Act 1956	Erstwhile Companies Act, 1956 along with the relevant rules made thereunder
Companies Act, 2013 / Companies Act	Companies Act, 2013 along with rules made thereunder
CS	Company Secretary
CSR	Corporate Social Responsibility
Depositories Act	The Depositories Act, 1996
Depository(ies)	A depository registered with SEBI under the Securities and Exchange Board of India (Depositories and Participants) Regulations, 1996
DIN	Director Identification Number
DP ID	Depository Participant’s Identification Number
EBITDA	Earnings before Interest, Tax, Depreciation and Amortisation
ECB	External Commercial Borrowings
ECB Master Directions	Master Direction – External Commercial Borrowings, Trade Credits and Structured Obligations dated March 26, 2019 issued by the RBI
ECS	Electronic Clearing System
EGM	Extraordinary General Meeting
EPF Act	Employees’ Provident Fund and Miscellaneous Provisions Act, 1952
EPS	Earnings per share
ESI Act	Employees’ State Insurance Act, 1948
FCNR Account	Foreign Currency Non Resident (Bank) account established in accordance with the FEMA
FEMA	The Foreign Exchange Management Act, 1999 read with rules and regulations thereunder
FEMA Regulations	The Foreign Exchange Management (Transfer or Issue of Security by a Person Resident Outside India) Regulations, 2017
FEMA Rules	Foreign Exchange Management (Non-debt Instruments) Rules, 2019
Financial Year/Fiscal	The period of 12 months commencing on April 1 of the immediately preceding calendar year and ending on March 31 of that particular calendar year
FIR	First information report
FPIs	Foreign portfolio investors as defined and registered under the SEBI FPI Regulations
Fugitive Economic Offender	An individual who is declared a fugitive economic offender under Section 12 of the Fugitive Economic Offenders Act, 2018
FVCI	Foreign Venture Capital Investors as defined and registered under the SEBI FVCI Regulations
GDP	Gross Domestic Product
GoI / Government	The Government of India
GST	Goods and Services Tax
HUF(s)	Hindu Undivided Family(ies)
ICAI	The Institute of Chartered Accountants of India
ICSI	The Institute of Company Secretaries of India
IFRS	International Financial Reporting Standards
IFSC	Indian Financial System Code
Income Tax Act / IT Act	Income Tax Act, 1961
Ind AS	The Indian Accounting Standards referred to in the Companies (Indian Accounting Standard)

Term	Description
	Rules, 2015, as amended
Indian GAAP	Generally Accepted Accounting Principles in India
Insider Trading Regulations	Securities and Exchange Board of India (Prohibition of Insider Trading) Regulations, 2015, as amended from time to time
Insolvency Code	Insolvency and Bankruptcy Code, 2016, as amended from time to time
ISIN	International Securities Identification Number
IT	Information Technology
MCA	The Ministry of Corporate Affairs, GoI
Merchant Banker	Merchant banker as defined under the Securities and Exchange Board of India (Merchant Bankers) Regulations, 1992 as amended
Mn / mn	Million
MOF	Ministry of Finance, Government of India
MOU	Memorandum of Understanding
MSME	Micro, Small, and Medium Enterprises
Mutual Funds	Mutual funds registered with the SEBI under the Securities and Exchange Board of India (Mutual Funds) Regulations, 1996
N.A. or NA	Not Applicable
NACH	National Automated Clearing House
NAV	Net Asset Value per Equity Share at a particular date computed based on total equity divided by number of Equity Shares
Net Worth	Net worth as defined under Regulation 2(1)(hh) of the SEBI ICDR Regulations, i.e., the aggregate value of the paid-up share capital and all reserves created out of the profits, securities premium account and debit or credit balance of profit and loss account, after deducting the aggregate value of the accumulated losses, deferred expenditure and miscellaneous expenditure not written off as per the restated balance sheet, but does not include reserves created out of revaluation of assets, write-back of depreciation and amalgamation
NR	Non-resident or person(s) resident outside India, as defined under the FE
NRE	Non- residential external
NRE Account	Non- residential external account
NRI	A person resident outside India, who is a citizen of India and shall have the same meaning as ascribed to such term in the Foreign Exchange Management (Deposit) Regulations, 2016
NRO	Non- resident ordinary
NRO Account	Non-resident ordinary account
BSE	BSE Limited
NSDL	National Securities Depository Limited
NTA	Net Tangible Assets
OCI	Overseas Citizen of India
ODI	Off-shore Derivate Instruments
p.a.	Per annum
P/E Ratio	Price/Earnings Ratio
PAN	Permanent Account Number
PAT	Profit After Tax
PBT	Profit Before Tax
PIO	Person of Indian Origin
PLR	Prime Lending Rate
R&D	Research and Development
RBI	The Reserve Bank of India
RBI Act	Reserve Bank of India Act, 1934
RoNW	Return on Net Worth
RTGS	Real Time Gross Settlement
SARFAESI Act	The Securitization and Reconstruction of Financial Assets and Enforcement of Security Interest Act, 2002
SAT	Securities Appellate Tribunal
SCRA	Securities Contract (Regulation) Act, 1956
SCRR	The Securities Contracts (Regulation) Rules, 1957
SEBI	The Securities and Exchange Board of India constituted under the SEBI Act, as amended
SEBI Act	The Securities and Exchange Board of India Act, 1992, as amended
SEBI AIF	Securities and Exchange Board of India (Alternative Investments Funds) Regulations, 2012, as

Term	Description
Regulations	amended
SEBI Regulations BTI	Securities and Exchange Board of India (Bankers to an Issue) Regulations, 1994
SEBI Regulations FPI	The Securities and Exchange Board of India (Foreign Portfolio Investors) Regulations, 2019
SEBI Regulations FVCI	Securities and Exchange Board of India (Foreign Venture Capital Investors) Regulations, 2000
SEBI Regulations ICDR	The Securities and Exchange Board of India (Issue of Capital and Disclosure Requirements) Regulations, 2018, as amended
SEBI Regulations Listing	Securities and Exchange Board of India (Listing Obligations and Disclosure Requirements) Regulations, 2015, as amended
SEBI Regulations Takeover	The Securities and Exchange Board of India (Substantial Acquisition of Shares and Takeovers) Regulations, 2011, as amended
SEBI Regulations VCF	Securities and Exchange Board of India (Venture Capital Funds) Regulations, 1996, since repealed and replaced by the SEBI (AIF) Regulations
SICA	Sick Industrial Companies (Special Provisions) Act, 1985, as amended from time to time
SME	Small and Medium Enterprises
Stamp Act	The Indian Stamp Act, 1899, as amended from time to time
State Government	The Government of a state in India
State Government	The Government of a State of India
Stock Exchange	Unless the context requires otherwise, refers to, the BSE Limited
TDS	Tax Deducted at Source
Trademarks Act	Trademarks Act, 1999, as amended
U.S. GAAP	Generally Accepted Accounting Principles in the United States of America
US\$/ USD/ US Dollar	United States Dollar, the official currency of the United States of America
USA/ U.S./ US	United States of America, its territories and possessions, any state of the United States of America and the District of Columbia
VAT	Value Added Tax
VCFs	Venture Capital Funds as defined in and registered with SEBI under the SEBI VCF Regulations or the SEBI AIF Regulations, as the case may be
w.e.f.	With effect from
Year/Calendar Year	Unless context otherwise requires, shall refer to the twelve-month period ending December 31

INDUSTRY AND BUSINESS RELATED TERMS

Term	Description
TOT	Transfer of Technology
TWA	Towed Wire Antenna
Naval Group	Naval Group is a major French industrial group specialized in naval defense design, development and construction. Naval Group designs, develops and manages the operational readiness of surface and underwater naval systems, and of their associated systems and infrastructures.
OEM	Original Equipment Manufacturer
CAGR	Compound annual growth rate
PSU	Public sector unit
GRSE	Garden Reach Shipbuilders and Engineers
HSL	Hindustan Shipyard
CSL	Cochin Shipyard Limited
CAD	Computer-aided design
CAM	Computer-aided manufacturing
NSS	Nuclear Sampling Systems
FPPS	Fuel Pool Purification System
SG	steam generators
SGBS	steam generator blow down system
VNC	vertical machining centers
CNC	Computer numerical control
Prototype	the first model or design of something from which other forms will be developed

Term	Description
TNC	Trade Negotiations Committee)
NAB	Nickel- Aluminium- Bronze
CUNI	Copper- Nickel
CUAL	Copper- Aluminium
NSTL	Naval Science & Technological Laboratory
DRDO	Defence Research and Development Organisation
GOI	Government of India
DPIIT	Department for Promotion of Industry and Internal Trade
IMO	International Maritime Organization
MoD	Ministry of Defence
DPSU	Defence Public Sector Undertaking
DIO	Defence Innovation Organization
DTTI	Defence Technology and Trade Initiative
FDI	Foreign Direct Investment
IBEF	India Brand Equity Foundation
MSME	Micro, Small & Medium Enterprises
MDL	Mazagaon Dockyard and Shipbuilders Limited
SWC	Shallow Water Craft
ACTAS	Active Towed Array Sonar
LFVDS	Low-Frequency Variable Depth Sonar
ASW	Anti-Submarine Warfare
KMP	Key Managerial Personnel
HF	High Frequency
GPS	Global positioning System
VLF	Very Low Frequency
LORAN C	Long-Range Navigation System, Version C
PNC	Price Negotiation Committee
CNC	Computer numerical control
VMC	Vehicle Management Compute
HVAC	Heating, Ventilation, and Air Conditioning
IPMS	Integrated Platform Management System
STW	Secure Tactical Wireless
HATS	Helicopter Aircrew Training System
DE-GT	Diesel Engine -Gas Turbines

The words and expressions used but not defined herein shall have the meaning as is assigned to such terms under the Companies Act, the SEBI ICDR Regulations, the SCRA, the Depositories Act or the rules and regulations made thereunder, unless the context otherwise indicates or implies.

Notwithstanding the foregoing, terms in “*Main Provisions of Articles of Association*”, “*Statement of Possible Tax Benefits*”, “*Industry Overview*”, “*Key Industrial Regulations and Policies*”, “*Financial Information*”, “*Outstanding Litigation and Material Developments*” and “*Issue Procedure*” on pages 228, 74, 77, 107, 140, 173 and 205, respectively of this Draft Prospectus, will have the meaning ascribed to such terms in these respective sections.

CERTAIN CONVENTIONS AND PRESENTATION OF FINANCIAL

Certain Conventions

All references in this Draft Prospectus to ‘India’ are to the Republic of India and its territories and possessions and all references herein to the ‘Government’, ‘Indian Government’, ‘GoI’, ‘Central Government’ or the ‘State Government’ are to the GoI, central or state, as applicable

Unless otherwise specified, any time mentioned in this Draft Prospectus is in Indian Standard Time (“IST”).

Unless stated otherwise, all references to page numbers in this Draft Prospectus are to the page numbers of this Draft Prospectus. In this Draft Prospectus, our Company has presented numerical information in “lakhs” units. One lakh represents 1,00,000.

Financial Data

Unless stated otherwise, the financial information in this Draft Prospectus is derived from our Restated Financial Statements. The Restated Financial Statements included in this Draft Prospectus are for the period ended September 30, 2024 and Fiscals ended March 31, 2024, March 31, 2023, March 31, 2022, and March 31, 2021, and have been prepared in accordance with Indian GAAP and the Companies Act, and have been restated in accordance with the SEBI (ICDR) Regulations. For further information, see please refer —Financial Information beginning on page no. 140 of this Draft Prospectus.

In this Draft Prospectus, any discrepancies in any table between the total and the sums of the amounts listed are due to rounding off. All figures in decimals have been rounded off to the second decimal and all percentage figures have been rounded off to two decimal places.

Our Company’s financial year commences on April 1 and ends on March 31 of the next year. Accordingly, all references to a particular financial year, unless stated otherwise, are to the 12 month period ended on March 31 of that year. Unless stated otherwise, or the context requires otherwise, all references to a “year” in this Draft Prospectus are to a calendar year.

There are significant differences between Indian GAAP, IFRS and US GAAP. The Company has not attempted to quantify their impact on the financial data included herein and urges you to consult your own advisors regarding such differences and their impact on the Company’s financial data. Accordingly to what extent, the financial statements included in this Draft Prospectus will provide meaningful information is entirely dependent on the reader’s level of familiarity with Indian accounting practices / Indian GAAP. Any reliance by persons not familiar with Indian Accounting Practices on the financial disclosures presented in this Draft Prospectus should accordingly be limited.

Unless the context otherwise indicates, any percentage amounts, as set forth in “*Risk Factors*”, “*Our Business*” and “*Management’s Discussion and Analysis of Financial Conditions and Results of Operations*” on page nos. 20, 89 and 159 respectively, of this Draft Prospectus, and elsewhere in this Draft Prospectus have been calculated on the basis of the Restated Financial Statements of our Company.

Currency and Units of Presentation

All references to “Rupees”, “Rs.” or “₹” are to Indian Rupees, the official currency of the Republic of India. All references to “US\$” or “US Dollars” or “USD” are to United States Dollars, the official currency of the United States of America.

This Draft Prospectus may contain conversions of certain US Dollar and other currency amounts into Indian Rupees that have been presented solely to comply with the requirements of the SEBI Regulations. These conversions should not be construed as a representation that those US Dollar or other currency amounts could have been, or can be converted into Indian Rupees, at any particular rate.

Definitions

For definitions, please refer the Chapter titled “*Definitions and Abbreviations*” on page no. 1 of this Draft Prospectus. In the Section titled “*Main Provisions of the Articles of Association of Our Company*” beginning on page no. 228 of this Draft Prospectus, defined terms have the meaning given to such terms in the Articles of Association.

Industry and Market Data

Unless stated otherwise, the industry and market data and forecasts used throughout this Draft Prospectus has been obtained from industry sources as well as Government Publications. Industry sources as well as Government Publications generally state that the information contained in those publications has been obtained from sources believed to be reliable but that their accuracy and completeness and underlying assumptions are not guaranteed and their reliability cannot be assured.

Further, the extent to which the industry and market data presented in this Draft Prospectus is meaningful depends on the reader’s familiarity with and understanding of the methodologies used in compiling such data. There are standard data gathering methodologies in the industry in which we conduct our business, and methodologies and assumptions may vary widely among different industry sources.

FORWARD-LOOKING STATEMENTS

This Draft Prospectus contains certain “forward-looking statements”. These forward-looking statements generally can be identified by words or phrases such as “aim”, “anticipate”, “believe”, “expect”, “estimate”, “intend”, “objective”, “plan”, “propose”, “project”, “will”, “will continue”, “will pursue” or other words or phrases of similar import. Similarly, statements that describe our strategies, objectives, plans or goals are also forward-looking statements. All forward-looking statements are subject to risks, uncertainties, expectations and assumptions about us that could cause actual results to differ materially from those contemplated by the relevant forward-looking statement. These forward-looking statements, whether made by us or a third party, are based on our current plans, estimates and expectations and actual results may differ materially from those suggested by such forward-looking statements.

Actual results may differ materially from those suggested by forward-looking statements due to risks or uncertainties associated with expectations relating to and including, regulatory changes pertaining to the industries in India in which we operate and our ability to respond to them, our ability to successfully implement our strategy, our growth and expansion, technological changes, our exposure to market risks, general economic and political conditions in India which have an impact on its business activities or investments, the monetary and fiscal policies of India, inflation, deflation, unanticipated turbulence in interest rates, foreign exchange rates, equity prices or other rates or prices, the performance of the financial markets in India and globally, changes in domestic laws, regulations and taxes and changes in competition in the industries in which we operate.

For further discussion of factors that could cause the actual results to differ from our estimates and expectations, see “Risk Factors”, “Our Business” and “Management’s Discussion and Analysis of Financial Position and Results of Operations” beginning on Page Nos. 20, 89 and 159, respectively, of this Draft Prospectus. By their nature, certain market risk disclosures are only estimates and could be materially different from what actually occurs in the future. As a result, actual gains or losses could materially differ from those that have been estimated.

We cannot assure investors that the expectations reflected in these forward-looking statements will prove to be correct. Given these uncertainties, investors are cautioned not to place undue reliance on such forward-looking statements and not to regard such statements as a guarantee of future performance.

Forward-looking statements reflect current views as on the date of this Draft Prospectus and are not a guarantee of future performance. These statements are based on our management’s beliefs and assumptions, which in turn are based on currently available information. Although we believe the assumptions upon which these forward-looking statements are based are reasonable, any of these assumptions could prove to be inaccurate, and the forward-looking statements based on these assumptions could be incorrect. Neither our Company, our Directors, the Promoters, the Syndicate nor any of their respective affiliates have any obligation to update or otherwise revise any statements reflecting circumstances arising after the date hereof or to reflect the occurrence of underlying events, even if the underlying assumptions do not come to fruition.

In accordance with the SEBI ICDR Regulations, our Company, the Promoters and the Lead Manager will ensure that the Bidders in India are informed of material developments until the time of the grant of listing and trading permission by the Stock Exchange for the Issue.

SECTION II - SUMMARY OF ISSUE DOCUMENT

The following is a general summary of the terms of the Issue. This summary should be read in conjunction with and is qualified in its entirety by, the more detailed information appearing elsewhere in this Draft Prospectus, including the sections entitled “*Risk Factors*”, “*Industry Overview*”, “*Outstanding Litigation and Material Developments*”, “*Our Promoters and Promoter Group*”, “*Financial Information*”, “*Objects of the Issue*”, “*Our Business*”, “*Issue Procedure*” and “*Main Provisions of Articles of Association*” beginning on Page Nos. 20, 77, 173, 133, 140, 62, 89, 205 and 228 respectively of this Draft Prospectus.

1. Summary of Industry

We operate in Naval Maritime and Defence Industry. For more details, please refer chapter titled “*Industry Overview*” beginning on page no. 77 of this Draft Prospectus.

2. Summary of Business

Our Company is engaged in the manufacturing and servicing for Indian Defence PSU Shipyard of Submarine machinery, critical component systems and test facilities. For further details, please refer to chapter titled “*Our Business*” beginning on page no. 89 of this Draft Prospectus.

3. Promoters

The Promoters of our Company are Sunil Menon and Gautam Makker. For further details, please refer to the chapter titled “*Our Promoters and Promoter Group*” beginning on page No. 133 of this Draft Prospectus.

4. Details of the Issue

Further Public issue of [●] equity shares of face value of ₹10/- each (“Equity Shares”) of M/s. CFE Fluid Control Limited (“The Company” or “The Issuer”) for cash at a price of ₹[●]/- per equity share, including a share premium of ₹[●]/- per equity share (“The Issue Price”), aggregating upto ₹1500.00 Lakhs (“The Issue”), of which [●] equity shares of face value of ₹10/- each for cash at a price of ₹[●]/- per equity share, aggregating to ₹[●].00 lakhs will be reserved for subscriptions by the Market Maker to the issue (The “Market Maker Reservation Portion”). The issue less market maker reservation portion i.e. Issue of [●] equity shares of face value of ₹10/- each for cash at a price of ₹[●]/- per equity share, aggregating to ₹[●] lakhs is here in after referred to as the “Net Issue”. The issue and the net issue will constitute [●]% and [●]% respectively of the post issue paid up equity share capital of the company.

5. Objects of the Issue

The Net Proceeds of the Issue (“Net Proceeds”) are currently expected to be deployed in accordance with the schedule as stated below:

(₹ in lakhs)

Sr. No.	Particulars	Amount to be funded from the Net Proceeds	Amount to be deployed from the Net Proceeds in FY 2024-25	Amount to be deployed from the Net Proceeds in FY 2025-26
1.	Funding Working capital requirements	7,260.00	3,860.00	3,400.00
2.	General Corporate Purpose	[●]	[●]	[●]
Total		[●]	[●]	[●]

6. Aggregate Pre Issue Shareholding of Promoters and Promoter Group

Following are the details of the pre-Issue shareholding of Promoters:

Name of the Shareholders	Number of Equity Shares	% of Pre-Issue Equity Share Capital
Promoter		
Sunil Menon	71,38,260	36.66
Gautam Makker	43,56,340	22.37
Promoter Group		
Sheela Makker	17,63,560	9.06
Niranjandev Makker	10,16,740	5.22

For further details, please refer to the chapter titled “*Capital Structure*” beginning on page No. 53 of this Draft Prospectus.

7. Summary of Financial Information

Following are the details as per the Restated Financial Statements as at September 30, 2024 and for the Financial Years ended on March 31, 2024, March 31, 2023 and March 31, 2022:

(₹ in lakhs, except share data)

Sr. No.	Particulars	September 30, 2024	March 31, 2024	March 31, 2023	March 31, 2022
1.	Share Capital	1,947.41	1,947.41	1,427.41	71.37
2.	Net Worth	13,900.85	12,593.61	2,498.83	1,485.33
3.	Revenue from operations	8,003.41	10,685.91	7,066.63	4,698.77
4.	Profit after Tax	1,406.61	1,708.78	1,013.60	773.32
5.	Earnings per Share	7.21	9.21	7.10	5.42
6.	Net Asset Value per equity share	71.38	64.67	17.51	208.12

For further details, please refer to the section titled “*Financial Information*” beginning on Page No. 140 of this Draft Prospectus.

8. Auditor qualifications which have not been given effect to in the Restated Financial Information

The Restated Financial Information do not contain any qualifications.

9. Summary of Outstanding Litigation

A summary of the pending tax proceedings and other material litigations involving our Company, our Promoters, our Directors and our Group Companies is provided below:

Name of Entity	Criminal Proceeding	Tax Proceeding	Statutory or Regulatory Proceeding	Disciplinary actions by the SEBI or Stock Exchanges against our Promoters	Material Civil Litigation / Other Litigations	Aggregate amount involved (Rs in lakhs) to the extent quantifiable
Company						
By the Company	-	-	-	-	-	-
Against the Company	-	2	-	-	-	397.12
Promoters and Directors						
By our Promoter and Directors	-	-	-	-	-	-
Against the Promoter and Directors	-	12	-	-	-	449.05
Group Companies						
By Group Companies	-	-	-	-	-	-
Against Group Companies	1	7	-	-	-	17,807.00

For further details, please refer to the chapter titled “*Outstanding Litigations and Material Developments*” beginning on Page No. 173 of this Draft Prospectus.

10. Risk Factors

Please see the chapter titled “*Risk Factors*” beginning on page 20 of this Draft Prospectus.

11. Summary of Contingent Liabilities

There are no material contingent liabilities as of September 30, 2024 and March 31, 2024.

12. Summary of Related Party Transactions

Related Party Transactions for the six months period ended on September 30, 2024 and for the Financial Years ended on March 31, 2024, March 31, 2023 and March 31, 2022 are as follows:

Particulars	As at September 30, 2024	As at March 31, 2024	As at March 31, 2023	As at March 31, 2022
Transactions during the years				
Key Managerial personnel				
Mr Sunil Menon				
Managerial Remuneration	42.00	84.00	42.00	-
Loan Taken during the year	-	-	-	11.60
Loan repaid during the year	-	-	-	12.00
Hitesh Birla				
Salary	8.01	14.23	9.47	-

Particulars	As at September 30, 2024	As at March 31, 2024	As at March 31, 2023	As at March 31, 2022
Gautam Makker				
Advance given during the year	-	7.80	-	-
Advance repaid during the year	-	7.80	-	-
Sonika Mehta				
Salary	1.08	2.16	0.90	-
Flash Forge Pvt Ltd				
Opening Balance	-	2,154.24	790.21	708.94
Loan Taken	-	133.70	2,265.35	922.93
Loan Repaid	-	2,339.75	1,068.60	841.66
Interest on loan	-	57.57	185.86	0.00
TDS on Loan	-	5.76	18.59	-
Outstanding Balance (Loan taken by CFF)	-	-	2,154.24	790.21
Total Remuneration/ Salary of KMPs	51.09	100.39	52.37	0.00
Total Employee Benefit Expenses	491.91	413.80	251.06	96.35
Total Remuneration/ Salary of KMPs as a % of Total Employee Benefit Expenses	10.39%	24.26%	20.86%	-
Balances during the year end-				
Loan Payable				
Flash Forge Pvt Ltd	-	-	2,154.24	790.21
Salary & Managerial Remuneration				
Sunil Menon	7.81	2.81	9.00	-
Hitesh Birla	1.32	0.53	1.28	-
Sonika Mehta	0.18	0.18	0.17	-
Reimbursement Expenses-Payable				
Flash Forge Pvt Ltd	64.66	1.96	68.20	-
Advances given to Flash Forge Pvt Ltd	-	-	-	2.72

For further details, kindly refer “Restated Financial Information –Related Party Disclosures under AS 18” from the chapter titled “Restated Financial Information” on Page No. 140 of this Draft Prospectus.

13. Financing Arrangements

There are no financing arrangements whereby the Promoters, members of the Promoter Group, the Directors of our Company and their relatives, have financed the purchase by any other person of securities of our Company other than in the normal course of the business of the financing entity during the period of six months immediately preceding the date of this Draft Prospectus.

14. The weighted average price of acquisition of Equity Shares by our Promoter in last one year preceding the date of this Draft Prospectus is below:

Name of Promoter	No of shares	Average price of Acquisition (₹)
Sunil Menon	Nil	NIL
Gautam Makker	Nil	NIL

15. The weighted average price of acquisition of Equity Shares by our Promoter in last 18 months preceding the date of this Draft Prospectus is below:

Name of Promoter	No of shares	Average price of Acquisition (₹)
Sunil Menon	1600	329.21
Gautam Makker	Nil	NIL

16. The weighted average price of acquisition of Equity Shares by our Promoter in last three year preceding the date of this Draft Prospectus is below:

Name of Promoter	No of shares	Average price of Acquisition (₹)*
Sunil Menon	67,81,392	0.08
Gautam Makker	41,38,518	NIL

*The promoters Sunil Menon and Gautam Makker has been allotted 67,79,827 shares and 41,38,523 shares pursuant to bonus issue dated July, 2022.

17. The average cost of acquisition of Equity Shares by our Promoter is:

Name of Promoter	Average price of Acquisition (₹)
Sunil Menon	5.57
Gautam Makker	5.50

18. Pre-FPO Placement

Our Company shall not undertake any pre-FPO placement.

19. Issue of equity shares made in last one year for consideration other than cash

Our Company has not issued any Equity Shares for consideration other than cash in the one year preceding the date of this Draft Prospectus.

20. Split or consolidation of Equity Shares in the last one year

Our Company has not undertaken a split or consolidation of the Equity Shares in the one year preceding the date of this Draft Prospectus.

21. Exemption from complying with any provisions of securities laws, if any, granted by SEBI

Our Company has not applied or received any exemptions from SEBI from complying with any provisions of securities laws.

SECTION III- RISK FACTORS

An investment in Equity Shares involves a high degree of financial risk. You should carefully consider all information in this Draft Prospectus, including the risks described below, before making an investment in our Equity Shares. The risk factors set forth below do not purport to be complete or comprehensive in terms of all the risk factors that may arise in connection with our business or any decision to purchase, own or dispose of the Equity Shares. This section addresses general risks associated with the industry in which we operate and specific risks associated with our Company. Any of the following risks, as well as the other risks and uncertainties discussed in this Draft Prospectus, could have a material adverse effect on our business and could cause the trading price of our Equity Shares to decline and you may lose all or part of your investment.

This Draft Prospectus also contains forward-looking statements that involve risks and uncertainties. We have described the risks and uncertainties that our management believes are material, but these risks and uncertainties may not be the only ones we face. Additional risks and uncertainties, including those we are not aware of or deem immaterial, may also result in decreased revenues, increased expenses or other events that could result in a decline in the value of our Equity Shares. In making an investment decision, prospective investors must rely on their own examination of our Company and the Offer, including the merits and risks involved. Unless specified or quantified in the relevant risk factors below, we are not in a position to quantify the financial or other implications of any of the risks described in this section. Investors are advised to read the risk factors carefully before taking an investment decision in this Offer. Investors should not invest in this Offer unless they are prepared to accept the risk of losing all or part of their investment, and they should consult their tax, financial and legal advisors about the particular consequences to you of an investment in the Equity Shares.

To obtain a better understanding of our business, you should read this section in conjunction with other chapters of this Draft Prospectus, including the chapters titled “Our Business”, Management’s Discussion and Analysis of Financial Condition and Results of Operations”, “Industry Overview” and “Financial Information” on page no’s 89, 159, 77 and 140 respectively of this Draft Prospectus, together with all other financial information contained in this Draft Prospectus. Our actual results could differ materially from those anticipated in these forward looking statements as a result of certain factors, including the considerations described below and elsewhere in this Draft Prospectus Unless otherwise stated, the financial data in this chapter is derived from our Restated Consolidated Financial Statements for the period ended September 30, 2024, March 31, 2024, March 31, 2023 and March 31, 2022 as included in “Financial Information” on page no. 140 of this Draft Prospectus.

INTERNAL RISK FACTORS

1. **Our Company, Group Companies, Promoters and Directors are parties to certain legal proceedings. Any adverse decision in such proceedings may have a material adverse effect on our business, results of operations and financial condition.**

Name of Entity	Criminal Proceeding	Tax Proceeding	Statutory or Regulatory Proceeding	Disciplinary actions by the SEBI or Stock Exchanges against our Promoters	Material Civil Litigation / Other Litigations	Aggregate amount involved (Rs in lakhs) to the extent quantifiable
Company						
By the Company	-	-	-	-	-	-
Against the Company	-	2	-	-	-	397.12
Promoters and Directors						
By Promoters	-	-	-	-	-	-
Against Promoters	-	12	-	-	-	449.05
Group Companies						
By Group Companies	-	-	-	-	-	-

Name of Entity	Criminal Proceeding	Tax Proceeding	Statutory or Regulatory Proceeding	Disciplinary actions by the SEBI or Stock Exchanges against our Promoters	Material Civil Litigation / Other Litigations	Aggregate amount involved (Rs in lakhs) to the extent quantifiable
Against Group Companies	1	7	-	-	-	17,807.00

*For further details of the outstanding litigation proceedings, see “*Outstanding Litigations and Material Developments*” beginning on page 173 of this Draft Prospectus.

There can be no assurance that these litigations will be decided in favour of our Promoter, Director, Promoter Group Entity and consequently it may divert the attention of our management and Promoter and waste our corporate resources and our Director and Promoter may incur significant expenses in such proceedings. If such claims are determined against our Director and Promoter, there could be a material adverse effect on our reputation, business, financial condition and results of operations, which could adversely affect the trading price of our Equity Shares. For the details of the cases filed by and against our Company, Group Companies, our Subsidiary, our Promoters and Directors, please refer to the chapter titled “*Outstanding Litigations and Material Developments*” on page no. 173 of this Draft Prospectus.

2. ***Our existing manufacturing facility and upcoming manufacturing facility are concentrated in a single region i.e. Khopoli and Pune, Maharashtra, hence we face geographical concentration related risks.***

Currently, our Company operates through one manufacturing facility, located at Khopoli, Maharashtra. Further, our Company has also taken on rent an additional facility at Pune, Maharashtra. Our success depends on our ability to successfully manufacture and deliver our products to execute our scheduled order book. Our manufacturing facilities are susceptible to damage or interruption or operating risks, such as human error, power loss, breakdown or failure of equipment, power supply or processes, performance below expected levels of output or efficiency, obsolescence, loss of services of our external contractors, terrorist attacks, acts of war, break-ins, earthquakes, other natural disasters and industrial accidents and similar events. During COVID-19 pandemic, on account of the government-imposed lockdown in India, operations at all of our manufacturing facilities were temporarily shut down and we were required to follow protocols as suggested by regulatory authorities, which impacted our ability to operate our manufacturing facilities at optimum utilizations.

Further, any materially adverse social, political or economic development, civil disruptions, or changes in the policies of the state government or state or local governments in this region could adversely affect our manufacturing operations, and require a modification of our business strategy, or require us to incur significant capital expenditure or suspend our operations. Due to the geographic concentration of our manufacturing operations and the operations of certain of our suppliers, our operations are prone to various hazards both natural and manmade. As on date of this Draft Prospectus, there are no past instances of losses due to such natural/ manmade hazards in our operation, however such disruptions in future could result in the damage or destruction of a significant portion of our manufacturing abilities, significant delays in shipments of our products and/or otherwise materially adversely affect our business, financial condition and results of operations. Further, continuous addition of industries in and around our manufacturing facilities without commensurate growth of its infrastructural facilities may put pressure on the existing infrastructure therein, which may adversely affect our business.

3. ***If we are not able to obtain, renew or maintain our statutory and regulatory licenses, registrations and approvals required to operate our business, it may have a material adverse effect on our business, results of operations and financial condition.***

Our Company requires certain statutory and regulatory permits, licenses and approvals to operate our business, some of which our Company has either received, applied for or is in the process of application. Many of these approvals are granted for fixed periods of time and need renewal from time to time. Non-renewal of the said permits and licenses would adversely affect our Company’s operations, thereby having a material adverse effect on our business, results of operations and financial condition.

Further, there can be no assurance that the relevant authorities will issue any of such permits or approvals in the time-frame anticipated by us or at all. Our Company requires the following statutory and regulatory registrations, licenses,

permits and approvals for our business but the same have not been obtained/not renewed by us, as on date of this Draft Prospectus such as the Company has not yet make an application to obtain No Objection Certificate from the concerned Fire Officer in accordance with the provisions of the Maharashtra Fire Prevention and Life Safety Measures Act, 2006, in respect of the Company's manufacturing facility.

Further, some of our permits, licenses and approvals are subject to several conditions and we cannot provide any assurance that we will be able to continuously meet such conditions or be able to prove compliance with such conditions to the statutory authorities, which may lead to the cancellation, revocation or suspension of the relevant permits, licenses or approvals. Any failure by us to apply in time, to renew, maintain or obtain the required permits, licenses or approvals, or the cancellation, suspension or revocation of any of the permits, licenses or approvals may result in the interruption of our operations and may have a material adverse effect on our business. If we fail to comply with all the regulations applicable to us or if the regulations governing our business or their manner of implementation change, we may incur increased costs, or be subject to penalties or may suffer a disruption in our business activities, any of which, could adversely affect our business or results of operations. For further details, please see "Key Industry Regulations and Policies" and "Government and Other Statutory Approvals" beginning on page nos. 107 and 177 respectively of this Draft Prospectus.

4. Significant portion of our revenue is derived from contracts with Indian Defence PSU Shipyard during period ended September 30, 2024 and Financial Year 2023-24, 2022-23 and 2021-22 Decline of order book, contracts, and change in their requirement or fall in budget will have material adverse effect on our business, financial condition and result of operation.

Our manufacturing facility is specifically equipped to serve the requirements of defence sector of our country. Our total revenue has grown in the last three years, from Rs. 4,698.77 lakhs in FY 2021-22, Rs. 7,066.63 lakhs in FY 2022-23 to Rs 10,685.91 lakhs in FY 2023-24. As of September 30, 2024, our total revenue for the current fiscal year stands at Rs. 8,003.41 lakhs. Details of revenue bifurcation into defence and non-defence sector are entailed as below:

(Rs in lakhs)

Particulars	For the period ended September 30, 2024	For the year ended March 31, 2024	For the year ended March 31, 2023	For the year ended March 31, 2022
Revenue from Defence Sector	7,453.77	10,645.88	7,066.63	4,207.71
Non-Defence Sector	549.64	40.02	-	491.06
Total Revenue	8,003.41	10,685.91	7,066.63	4,698.77

Our Company is heavily dependent on Indian Defence PSU Shipyard for its business revenue, contracts and cash flows. Our business substantially relies on delivering the components required in shipbuilding and submarines of Indian Defence PSU Shipyard. Components like valves, ball, gear box, hydraulic systems, nuclear sampling systems, titanium air bottles, towed wire antenna systems etc are manufactured using technology specially designed for defence sector and delivered as per order book to Indian Defence PSU Shipyard. We cannot assure you that we can maintain the historical levels of business from these clients/ OEMs or that we will be able to replace these clients/ OEMs in case we lose any of them.

Further, our customer may experience financial or other difficulties such as force majeure events, changes in laws, economic conditions of the customer and labor problems which may result in delays to the order being received and executed. Our business is affected by the price, quality, availability and the timely delivery of the component parts that we manufacture for defence sector. It may be difficult to find such large contracts from any other customers that continue to rely on us for their requirements. We have our technology designed in a way to satisfy their requirements, so we have our unit customized for major customer.

The projects of submarine in which we supply the components have also authorized us for the repair and maintenance contract. The submarines have a life of three decades. Our Company have orders to supply our components required for the submarine repairs and maintenance for its complete life. However, in case of any foreseen development w.r.t Indian Defence PSU Shipyard & related OEMs would affect our future results of operations and financial conditions.

5. Our business of manufacturing and supply of components, equipment and services required by Indian Defence PSU Shipyard is significantly dependent on the technology, process and product development of such components.

Our manufacturing facility is built in a way to cater the requirements of the Defence sectors in their submarine projects. For manufacturing the specific components, we have acquired technology, process knowhow and product development from our suppliers Coyard, located at France. Our Company is also manufacturing additional product line for submarine

which is Towed Wire Antenna (TWA) which is used as an underwater communication device. Our Company has been continuously obtaining technology, process, knowhow and product development to manufacture this product from Nereides, France who is engaged in manufacturing TWA. We have invested thereby incurred expenditure of Rs. 849.33 lakhs in F.Y 2023-24 for the purchases of "Towed Wired Antenna" (TWA) technology pursuant to Technology Transfer Agreement.

Being a technology-oriented Company, we are heavily dependent on the technology, we will not be able to manufacture the product as per latest and updated requirement of the defence sector and it may affect our reputation and future business operations. Considering the nature of our business activities, our Company shall consistently make all efforts to develop new product prototype and expand our business operations.

6. Our Promoter Group Entity is engaged in business activities which is similar to our line of business. This may be a potential source of conflict of interest for us and which may have an adverse effect on our business, financial condition and results of operations.

Our Promoters have interests in other companies and entities that may compete with us, including other Group Company that conducts businesses with operations in Defence sector. Our Promoters have also promoted other companies and may continue to do so. For details, please refer to the Chapter titled "Our Management" and "Our Promoters and Promoter Group" on page no 120 and 133 respectively of this Draft Prospectus.

Further, our Company has not entered into any non- compete agreement with the group company and hence there can be no assurance of any conflict of interests which may arise in allocating or addressing business opportunities and strategies amongst our Company and our Group Company in circumstances where our interests differ from theirs. In cases of conflict, our Promoter may favour other Companies in which our Promoter has an interest. Hence, conflict of interest may occur between our business and the businesses of our Group Companies which could have an adverse effect on our business, financial condition, results of operations and prospects.

7. Our company is significantly dependent on few customers for our revenue in a particular financial year. The loss of any one or more of such customers may have a material effect on our business operations and profitability.

The percentage of revenue derived from our top five and top ten customers for period ended September 30, 2024 and year ended 2023-24, 2022-23, 2021-22 are given below:

(Rs in lakhs)

Sr. No	Particulars	For period ended September 30, 2024		F.Y 2023-24		F.Y 2022-23		F.Y 2021-22	
		Revenue	%	Revenue	%	Revenue	%	Revenue	%
1	Income from Top 5 Customer	7,310.91	91.35%	10,465.78	97.94%	7,066.63	100%	4,649.01	98.94%
2	Income from Top 10 Customer	8,003.41	100.00%	10,685.91	100.00%	7,066.63	100.00%	4,698.77	100.00%

Since our business is completely dependent on defence sector, government policy and our top ten customers includes Indian Defence PSU Shipyard and its associates, we could experience a reduction in our results of operations, cash flows and liquidity if we lose one or more of these customers or the amount of business we obtain from them is reduced for any reason.

Further, in the event of loss of one or more set of such customers on whom we are dependent for our business, we cannot assure you that we may be able to offset such loss of business by identifying a new customer of our products. While we believe we have maintained good and long-term relationships with our customers, there can be no assurance that we will continue to have such long-term relationship with them. We cannot assure that we shall generate the same quantum of business, or any business at all, from these customers, and loss of business from one or more of them may adversely affect our revenues and profitability.

8. We have reported negative net cash flows in the past and may do so in the future.

The following table sets forth net cash inflow/(outflow) from operating, investing and financing activities for period September 30, 2024 and Fiscals 2024, 2023 and 2022:

(Rs in lakhs)

Particulars	For the period ended September 30, 2024	For the year ended March 31, 2024	For the year ended March 31, 2023	For the year ended March 31, 2022
Net cash flow from operating activities	(678.18)	(2,675.37)	(927.20)	919.69
Net cash flow from Investing activities	(174.63)	(1,659.53)	(1,939.46)	10.45
Net cash flow from financing activities	(457.68)	5,904.32	2,619.28	(726.87)
Net Cash Flow	(1,310.49)	1,569.42	(247.37)	203.27

We had negative cash flows from operating activities for period ended September 30, 2024, F.Y 2023-24 and F.Y 2022-23 due to the significant change in trade receivables, inventories, trade payables and other current assets. Further we have negative cash flows from investing activities for period ended September 30, 2024, F.Y 2023-24 and F.Y 2022-23 since the Company has invested in plant and machinery and intangible assets during this period. We had negative cash flows from financing activities for September 30, 2024 due to repayment of borrowings and interest expenses

We cannot assure you that our net cash flows will be positive in the future. If our Company is not able to generate sufficient cash flows, our Company may not be able to generate sufficient amounts of cash flow to finance our projects, make new capital expenditure, pay dividends, make new investments or fund other liquidity needs which could have a material adverse effect on our business and results of operations.

9. ***In addition to normal remuneration, other benefits and reimbursement of expenses our directors (including our Promoters) and Key Management Personnel are interested in our Company to the extent of their shareholding and dividend entitlement in our Company.***

Some of our Directors (including our Promoter) and Key Management Personnel are interested in our Company to the extent of their shareholding, loan and dividend entitlement in our Company, in addition to normal remuneration or benefits and reimbursement of expenses. Our Promoters and Promoter Group currently holds 73.30% of shareholding of our Company and will hold [.] % of post issue shareholding of our Company. We cannot assure you that our directors or our Key Management Personnel would always exercise their rights as Shareholders to the benefit and best interest of our Company. As a result, our directors will continue to exercise significant control over our Company, including being able to control the composition of our board of directors and determine decisions requiring simple or special majority voting, and our other Shareholders may be unable to affect the outcome of such voting. Our directors may take or block actions with respect to our business, which may conflict with our best interests or the interests of other minority Shareholders, such as actions with respect to future capital raising or acquisitions. We cannot assure you that our directors will always act to resolve any conflicts of interest in our favor, thereby adversely affecting our business and results of operations and prospects.

We have entered into related party transactions which are at an arm's length basis from time to time with our promoters, directors and group companies. Some of the regular related party transactions involved in our company are explained below:

- Our Company has obtained interest free unsecured loan from our director in the past.
- Our Company has obtained unsecured loan from our promoter group company in the past at an interest rate of 12% p.a. Hence, they might be interested in interest and repayment of such loans.

Outstanding details of such loan as on September 30, 2024 is given below:

We cannot assure you that such transactions, individually or in the aggregate, will not have an adverse effect on our results of operations and financial condition.

Related Party Transactions for the six months period ended on September 30, 2024 and for the Financial Years ended on March 31, 2024, March 31, 2023 and March 31, 2022 are as follows:

Particulars	As at September 30, 2024	As at March 31, 2024	As at March 31, 2023	As at March 31, 2022
<i>Transactions during the years</i>				

Particulars	As at September 30, 2024	As at March 31, 2024	As at March 31, 2023	As at March 31, 2022
Key Managerial personnel				
Mr Sunil Menon				
Managerial Remuneration	42.00	84.00	42.00	-
Loan Taken during the year	-	-	-	11.60
Loan repaid during the year	-	-	-	12.00
Hitesh Birla				
Salary	8.01	14.23	9.47	-
Gautam Makker				
Advance given during the year	-	7.80	-	-
Advance repaid during the year	-	7.80	-	-
Sonika Mehta				
Salary	1.08	2.16	0.90	-
Flash Forge Pvt Ltd				
Opening Balance	-	2,154.24	790.21	708.94
Loan Taken	-	133.70	2,265.35	922.93
Loan Repaid	-	2,339.75	1,068.60	841.66
Interest on loan	-	57.57	185.86	0.00
TDS on Loan	-	5.76	18.59	-
Outstanding Balance (Loan taken by CFF)	-	-	2,154.24	790.21
Total Remuneration/ Salary of KMPs	51.09	100.39	52.37	0.00
Total Employee Benefit Expenses	491.91	413.80	251.06	96.35
Total Remuneration/ Salary of KMPs as a % of Total Employee Benefit Expenses	10.39%	24.26%	20.86%	-
Balances during the year end-				
Loan Payable				
Flash Forge Pvt Ltd	-	-	2,154.24	790.21
Salary & Managerial Remuneration				
Sunil Menon	7.81	2.81	9.00	-
Hitesh Birla	1.32	0.53	1.28	-
Sonika Mehta	0.18	0.18	0.17	-
Reimbursement Expenses-Payable				
Flash Forge Pvt Ltd	64.66	1.96	68.20	-
Advances given to Flash Forge Pvt Ltd	-	-	-	2.72

10. *Our Promoters and Key Managerial Personnel play key role in our functioning and we heavily rely on their knowledge and experience in operating our business and therefore, it is critical for our business that they remain associated with us.*

Our Promoters, along with the group key managerial personnel, have over the years build relations with clients, government agencies and other persons who are connected with us. Their inputs and experience are valuable for the

development of business and operations and the strategic decisions taken by our Company. The loss of their services could impair our ability to implement our strategy, and our business, financial condition, results of operations and prospects may be materially and adversely affected. Further, our Promoters have also promoted other companies and may continue to do so. If they divert their attention to the other companies, we may not be able to function as efficiently and profitably as before. Our success also depends upon the continued services of our Key Managerial Personnel and our ability to retain them. We may have to incur additional costs to replace the services of our promoters or we may not be able to do so at all, which could adversely affect our business operations and affect our ability to continue to manage and expand our business

We cannot assure you that we will be able to retain these employees or find adequate replacements in a timely manner, or at all. We may require a long period of time to hire and train replacement personnel when qualified personnel terminate their employment with our Company. We may also be required to increase our levels of employee compensation more rapidly than in the past to remain competitive in attracting employees that our business requires. Any inability to attract and retain talented employees or the resignation or loss of key management personnel, may have an adverse impact on our business, future financial performance and the price of our Equity Shares.

11. Trade Receivables, Inventories short term loans and advances and other current assets form a substantial part of our Total Assets. Failure to manage our trade receivables and inventories could have an adverse effect on our net sales, profitability, cash flow and liquidity.

Our business is working capital intensive and hence, Trade Receivables, Inventories, short term loans and advances and other current assets form substantial part of our total assets.

(Rs in lakhs)

Particulars	For the period ended September 30, 2024	For the year ended March 31, 2024	For the year ended March 31, 2023	For the year ended March 31, 2022
Inventories	5,796.14	5,268.18	3,727.78	2,083.36
Trade Receivables	5,210.00	882.30	813.31	1,314.39
Short term loans and advances	2,177.71	3,287.66	834.88	829.46
Other Current Assets	994.47	993.94	657.05	122.15
Sub-total (A)	14,168.82	10,432.08	6,033.02	4,349.37
Total Assets	18,476.42	16,115.94	8,868.00	5,595.70
A as a % of Total Assets	76.74%	64.73%	68.03%	77.73%

The results of operations of our business are dependent on our ability to effectively manage our inventory, short-term loan and advances and other current assets and trade receivables. We generally procure materials on the basis of management estimates based on past requirements and future estimates. In case we fail to sell the products, we manufactured based on the specific requirement of our customers, we may be required to write-down our inventory or create additional vendor financing, all of which could have an adverse impact on our income and cash flows. We run a risk to execute order book on scheduled time or else we may face obligations and liabilities of late delivery and lead to a liquidity crunch, thereby adversely affecting our business and results of operations. A liquidity crunch may also result in increased working capital borrowings and, consequently, higher finance cost which will adversely impact our profitability.

12. Our Balance sheet has a significant portion of Property Plant and Equipment and intangible assets. Any destruction, breakdown, theft our major plants or equipment or failures to repair or maintain the same and new updation and innovation i.e technological change as compared to our intangible assets may adversely affect our business, cash flows, financial condition and results of operations.

We continuously invest significantly on plant and machinery of latest technology and higher capacity and efficiency for our manufacturing facility. We own a large number of equipment and machinery used in our operations. We have also invested in technologies and process development assets. To maintain our capability to undertake projects, we may have to purchase machines and equipment built with the latest technologies and knowhow. We cannot assure you that we will be immune from the associated operational risks such as the obsolescence of our plants or equipment, destruction, theft or major equipment breakdowns or failures to repair our major plants or equipment, which may result in their unavailability, project delays, cost overruns and even defaults in our order book.

Details of Property Plant and Equipments and intangible assets for period ended September 30, 2024, financial year ended 2023-24, 2022-23 and 2021-22 are as below:

(Rs in lakhs)

Particulars	For the period ended September 30, 2024	For the year ended March 31, 2024	For the year ended March 31, 2023	For the year ended March 31, 2022
Property Plant and Equipments and Intangible assets (PPE &I)	3,766.85	3,870.87	2,628.39	812.91
Total Assets	18,476.42	16,115.93	8,868.00	5,595.70
PPE &I as a % of Total Assets	20.39%	24.02%	29.64%	14.53%

The latest technologies used in newer models of equipment may improve productivity significantly and render our older equipment obsolete. Obsolescence, destruction, theft or breakdowns of our major plants or equipment may significantly increase our equipment purchase cost and the depreciation of our plants and equipment, as well as change the way our management estimates the useful life of our plants and equipment. We may have to incur high cost when our plants or equipment are not readily available from the market or requires services from original equipment manufacturers. We incur certain cost of repair and maintenance of Rs 7.41 lakhs, 3.15 lakhs, 14.12 lakhs and 1.47 lakhs for period ended September 30, 2024, March 31, 2024, March 31, 2023 and March 31, 2022 respectively. We may experience significant price increases due to supply shortages, inflation, transportation difficulties or unavailability of bulk discounts. Such replacement, repair or maintenance failures or price increases may not be adequately covered by the insurance policies availed by our Company and may have an adverse effect on our business, cash flows, financial condition and results of operations.

13. ***The deployment of the Net Proceeds from the Fresh Issue is based on management estimates and have not been independently appraised by any bank or financial institution and is not subject to any monitoring by any independent agency and our Company's management will have flexibility in utilizing the Net Proceeds from the Fresh Issue.***

The deployment of the funds towards the objects of the Issue is entirely at the discretion of the Board and our Board will monitor the utilization of Net Proceeds. Also, in terms of Regulation 262 of the SEBI (ICDR) Regulations, we are not required to appoint a monitoring agency since the Fresh Issue size is not in excess of ₹ 100 crores. The management of our Company will have discretion to use the Net Proceeds from the Issue, and investors will be relying on the judgment of our Company's management regarding the application of the Net Proceeds from the Issue.

Given the dynamic nature of our business, we may have to revise our business plan from time to time and consequently our funding requirements and deployment on account of variety of factors such as our financial condition, business and strategy, including external factors such as market conditions, competitive environment, costs of commodities and interest/ exchange rate fluctuations which may not be within the control of our management. Any inability on our part to effectively utilize the Issue proceeds could adversely affect our operational and financial performance.

Further, pursuant to Section 27 of the Companies Act 2013, any variation in the objects would require a special resolution of the Shareholders and would be required to provide an exit opportunity to the shareholders who do not agree with our proposal to change the Objects of the Issue, at a price and manner as specified in the SEBI ICDR Regulations. Additionally, the requirement on Promoters or controlling shareholders to provide an exit opportunity to such dissenting shareholders may deter the Promoters or controlling shareholders from agreeing to the variation of the proposed utilization of our Net Proceeds, even if such variation is in our interest. Further, we cannot assure you that our Promoters or the controlling shareholders will have adequate resources at their disposal at all times to enable them to provide an exit opportunity at the price which may be prescribed by SEBI. Accordingly, prospective investors in the Issue will need to rely upon our management's judgment with respect to the use of Net Proceeds.

14. ***We are dependent on a few suppliers for supply of raw materials and any major disruption to the timely and adequate supplies of our raw materials could adversely affect our business, results of operations and financial condition.***

Our Company is dependent on a few suppliers for procuring the raw materials for manufacturing of its products and we do not currently have long term agreements or exclusive supply arrangements with any of our vendors.

Details of our top five suppliers are as below:

(Rs in lakhs)

Particulars	For period ended September 30, 2024		F.Y 2023-24		F.Y 2022-23		F.Y 2021-22	
	Purchase	%	Purchase	%	Purchase	%	Purchase	%
Income from Top 5	3,498.53	81.62%	5,228.31	74.56%	5,382.23	88.54%	3,078.21	96.44%

Particulars	For period ended September 30, 2024		F.Y 2023-24		F.Y 2022-23		F.Y 2021-22	
	Purchase	%	Purchase	%	Purchase	%	Purchase	%
Suppliers								

We believe that the quality of raw materials, the transparent pricing, location advantage, etc. are also some of the major reasons our Company prefers to procure these raw materials from these suppliers. If any of our major suppliers ceases to have business dealings with us or materially reduces the quantity of raw materials supplied to us and we are unable to secure new suppliers for such raw materials to meet the requirements at our manufacturing plants, our production schedule may be delayed and our business, financial condition, results of operations and prospects will be adversely affected. Further our raw material supply and pricing may become volatile due to a number of factors beyond our control, including global demand and supply, general economic and political conditions, transportation and labour costs, labour unrest, natural disasters, competition and there are inherent uncertainties in estimating such variables, regardless of the methodologies and assumptions that we may use. Therefore, we cannot assure that we will be able to procure adequate supplies of raw materials in the future, as and when we need them on commercially acceptable terms. Further, there can be no assurance that we will be able to effectively manage relationships with our existing or new suppliers or that we will be able to enter into arrangements with new suppliers at attractive terms or at all. If we fail to successfully leverage our existing and new relationships with suppliers, our business and financial performance could be adversely affected.

15. *Our failure to keep our technical knowledge confidential could erode our competitive advantage. We possess certain technical knowledge about our products.*

We have certain tie-up with foreign supplier who has over the time given us access to their process, design, research and development results. This tie-up has been resulted from continuous effort and experience of our promoter and key managerial personnel in this industry. Goodwill of our company in the defence sector over the years has been rewarded with such technical knowledge that we possess which gives us a competitive edge. Some of our technical knowledge is protected only by secrecy. As a result, we cannot be certain that our technical knowledge will remain confidential in the long run. Even if all reasonable precautions, whether contractual or otherwise, are taken to protect our confidential technical knowledge of our products and business, there is still a danger that certain proprietary knowledge may be leaked, either inadvertently or willfully, at various stages of the production process.

A significant number of our employees have access to confidential design and product information and there can be no assurance that this information will remain confidential. Moreover, certain of our employees may leave us and join our various competitors. Although we have enforced non-disclosure agreements in respect of research and development and certain other key employees, we cannot guarantee that we will be able to successfully protect information. In the event that the confidential technical information in respect of our products or business becomes available to third parties or to the general public, any competitive advantage that we may have over other companies in the defence sector could be harmed. If a competitor is able to reproduce or otherwise capitalize on our technology, it may be difficult, expensive or impossible for us to obtain necessary legal protection. Consequently, any leakage of confidential technical information could have an adverse effect on our business, results of operations, financial condition and future prospects.

16. *Currently, our Company operates through its manufacturing facility at Khopoli. The unexpected loss, shutdown or slowdown of operations at our manufacturing facility could have a material adverse effect on our business, results of operations and financial condition.*

Any significant interruption in manufacturing at our facility could have a material adverse effect on our business, results of operations and financial condition. Our Company currently operated through one unit where the manufacturing of all our the products takes place which is located at Khopoli, which are subject to the normal risks of industrial production, including equipment breakdowns, labor shortages, natural disasters, industrial accidents, power interruptions etc. In case of any disruption at such facilities, it may adversely affect the manufacturing cycle, and may lead to time over-run in the execution of the project and timely delivery of our product. Our manufacturing facilities require a significant amount and continuous supply of electricity and any shortage or non-availability of electricity may adversely affect our operations.

17. *We do not own our Corporate Office which is being used by us currently.*

Our Corporate Office premise which is situated at 503, Delphi, A wing Hiranandani Business Park, Powai Mumbai-400076, is taken on leasehold basis for term from October 01,2022 to September 30,2027. Upon the termination of the

lease agreement, we are required to return the said premise to the licensor. Further, the term of the lease agreement may or may not be renewed.

In the event the licensor terminates or does not renew the lease on commercially acceptable terms, or at all, we shall be required to vacate the premises. We may be required to identify alternate premises and enter into fresh lease agreement. Such a situation could result in loss of business and may adversely affect our operations and profitability. For further details, please see paragraph titled “Properties” under the chapter titled “Our Business” beginning on page no 89 of this Draft Prospectus.

18. ***Our Company might be unable to meet certain delivery obligations including timelines of delivery, due to which, it could become liable to claims by customers, suffer adverse publicity and incur substantial costs, which in turn could adversely affect our results of operations.***

Most projects/orders that we have received in connection with our business contain a penalty or liquidated damage clause for delay in the completion of a project that takes effect should the completion of a project be delayed. Our projects are typically subject to a completion schedule. We are also required to provide performance guarantees to customers to complete projects on schedule. Our Company has commitments for safe and timely delivery of the products. Any failure to meet the scheduled timelines set by our customers or loss or damage may lead to our customers raising claims against us.

Details of late delivery charges incurred by us are as below:

(Rs in lakhs)

Particulars	For the period ended September 30, 2024	For the year ended March 31, 2024	For the year ended March 31, 2023	For the year ended March 31, 2022
Late Delivery Charges	2.58	31.02	131.61	79.76
Revenue	8,003.41	10,685.91	7,066.63	4,698.77
Late delivery charges as a % of Revenue	0.03%	0.29%	1.86%	1.70%

We have in the past not been able to complete some of our projects within the schedule specified, which may led to some of our clients invoking our performance guarantees or withholding amounts owed to us/ however we have not paid any material penalty. Any failures to adhere to a contractually agreed schedule for reasons other than the agreed force majeure events could result in our being required to pay liquidated damages, which would usually be a certain percentage of the total project cost, or lead to forfeiture of security deposits or invocation of performance guarantees. Delays in the completion of projects could also increase our working capital requirements and cause damage to our reputation, which could in turn adversely affect our ability to prequalify for projects.

19. ***Failure to procure and/ or maintain adequate insurance cover in connection with our business may adversely affect our operations and profitability.***

Our Company has obtained insurance coverage in respect of certain risks. There can be no assurance that our insurance policies will be adequate to cover the losses in respect of which the insurance has been availed. Our principal types of insurance coverage include Plant and Machinery, Building and Stock Insurance. As on March 31, 2022, March 31, 2023, March 31, 2024 and for the six months period ended September 30, 2024, we had incurred insurance expenditure of ₹ 2.08 lakhs, ₹ 2.56 lakhs, ₹ 4.98 lakhs and ₹ 4.22 lakhs. If we suffer a significant uninsured loss or if insurance claim in respect of the subject-matter of insurance is not accepted or any insured loss suffered by us significantly exceeds our insurance coverage, our business, financial condition and results of operations may be materially and adversely affected. Further, there is no assurance that the insurance premium payable by us will be commercially viable or justifiable. For further details, please refer to the chapter titled “Our Business” on page 89 of this Draft Prospectus.

20. ***We depend on third parties for our suppliers, logistics and transportation needs. Any disruptions in the same may adversely affect our operations, business, cash flows and financial condition.***

All the transportation, logistics needs for our product supplies are handled by third parties. We do not have an in-house transportation facility and we rely on third party transportation and other logistic facilities at every stage of our business activity including for procurement of products from our suppliers and for transportation from our distribution centres to various stores. However, we do not enter into any formal agreements with the third parties for our logistics and transportation needs. Since the cost of our goods carried by third party transporters is typically much higher than the consideration paid for transportation, it may be difficult for us to recover damages for damaged, delayed or lost goods.

Our operations and profitability are dependent upon the availability of transportation and other logistic facilities in a timely and cost-efficient manner. Accordingly, our business is vulnerable to increased transportation costs, transportation strikes and lock-outs, shortage of labour, delays and disruption of transportation services for events such as weather-related problems and accidents.

Further, movement of goods encounters additional risks such as accidents, pilferage, spoilage, shrinkage and our inability to claim insurance may adversely affect our operations, results of operations and financial condition. Although we have not experienced any material logistics and transport related disruptions in the past, any prolonged disruption or unavailability of such facilities in a timely manner could result in delays or non-supply or may require us to look for alternative sources which may not be cost-effective, thereby adversely affecting our operations, results of operations, cash flows and financial condition. We rely on third party raw material suppliers for our business. We are exposed to the risk of these suppliers, third party manufacturers and service providers failing to adhere to the standards set for them by us and statutory and/ or regulatory bodies in respect of factors such as quality, quantum of production, weights and measures and safety standards and non-compliance of relevant rules and regulations, and any consequent action by such statutory and/ or regulatory bodies or otherwise, could adversely affect our business operations, results of operations, cash flows and financial condition, due to reasons such as shortage of supply, product liability claims and product recalls.

21. Failure in supply of electricity or power can lead to significant disruption in manufacturing process and can affect our operations.

We consume substantial power and fuel at our manufacturing facilities. Electricity expenses represent a significant portion of the direct cost associated with cost of material consumed.

Details of electricity expenditure for period September 30, 2024 and Financial year 2023-24, 2022-23 and 2021-22 are a below:

(Rs in lakhs)

Particulars	For the period ended September 30, 2024	For the year ended March 31, 2024	For the year ended March 31, 2023	For the year ended March 31, 2022
Electricity Expenses	34.77	48.62	36.41	48.87
Revenue	8,003.41	10,685.91	7,066.63	4,698.77
Electricity as a % of Revenue	0.43%	0.45%	0.52%	1.04%

If electricity cost rises or supply arrangements were disrupted, our profitability could decline. We source most of our electricity requirements for our manufacturing facilities from the Maharashtra State Electricity Distribution Co. Ltd. The cost of electricity from state electricity boards could be significantly higher, thereby adversely affecting our cost of production and profitability. Further, if for any reason such electricity is not available, we may need to temporary shut down our plants until an adequate supply of electricity is restored which will lead to the loss of production in progress and may affect our results of operations

22. We face foreign exchange risks, primarily in our import and procurement operations that could adversely affect our results of operations.

We are exposed to foreign currency exchange risk as we have imported our raw materials from foreign. We deal with supplier in foreign currency and are affected with its fluctuation. We have even recorded foreign fluctuation gain and losses in our financial statement. For period September 30, 2024 and Fiscals 2024, 2023 and 2022, purchases of raw materials from outside India were ₹ 2,215.77 lakhs, ₹ 829.96 lakhs, ₹446.05 lakhs and ₹ 175.81 lakhs, constituting 51.69%, 11.84%, 7.34% and 5.51%, respectively, of our total purchases of raw materials. Fluctuation in currency exchange rates influences our results of operations. As and when outflows are incurred, the required foreign exchange is bought from market at the then prevailing exchange rate. In future we may continue to incur capital expenditures, including raw materials, equipment and machinery, denominated in foreign currencies. The exchange rates between Rupee and USD and between Rupee and EUR have changed substantially in recent years and may continue to fluctuate significantly in the future. Accordingly, any decline in the value of the Rupee against the U.S. Dollar and Euro or any other foreign currency would increase the Rupee cost of such raw materials. Although we closely follow our exposure to foreign currencies in an attempt to reduce the risks of currency fluctuations, these activities are not always sufficient to protect us against incurring potential losses if currencies fluctuate significantly. Any such losses on account of foreign exchange fluctuations may affect our results of operations.

23. *If we are unable to continue to grow at same rate as in past and manage our growth effectively or raise additional capital, our business, future financial performance and results of operations could be materially and adversely affected.*

The success of our business will depend greatly on our ability to effectively implement our business and growth strategy. As part of our growth strategy, we aim to, among other things. For details, see “*Our Business – Our Business Strategy*” on page 89 of this Draft Prospectus.

Our Company has been able to consistently achieve abnormal growth in business, revenue and profit with its dedication to serve the best and dive deeper into defense sector each year. Details of rise in percentage term for the key financial indicators are as below:

Particulars	F.Y 2023-24	F.Y 2022-23
Revenue from Operation	10,685.91	7,066.63
Percentage rise in Revenue from Operation year on year		51.22%
EBITDA	3,085.38	1,882.82
Percentage rise in EBITDA year on year		63.87%
Profit after Tax (PAT)	1,708.78	1,013.60
Percentage rise in profit year on year		59.32%

Particulars	F.Y 2022-23	F.Y 2021-22
Revenue from Operation	7,066.63	4,698.77
Percentage rise in Revenue from Operation year on year		50.39%
EBITDA	1,882.82	1,252.93
Percentage rise in EBITDA year on year		50.274%
Profit after Tax (PAT)	1,013.60	773.32
Percentage rise in profit year on year		31.07%

We cannot assure you that we will be able to achieve business and grow in same rate in the future. In pursuing our growth strategy, we will require additional capital investments and cash outlays, which may have a material impact on our cash flows and results of operations. Our ability to manage our growth effectively requires us to forecast accurately our sales, growth and manufacturing capacity and to expand funds to improve our operational, financial and management controls, reporting systems and procedures. Moreover, even if we secure the required funding, there is no assurance that we will be able to successfully implement our strategies. We may also face difficulties in effectively implementing new technologies required in designing, developing and manufacturing new products and solutions and may not be able to recover our investments. Many of our contracts contain performance obligations that require innovative design capabilities are technologically complex or involve developmental costs. An inability to implement our future business plan, manage our growth effectively or failure to secure the required funding on favorable terms or at all could have a material and adverse effect on our business, future financial performance and results of operations.

24. *Any failure to protect or enforce our rights to own or use trademarks and brand names and identities could have an adverse effect on our business and competitive position.*



Our corporate logo “” & Word mark “CFF FLUID CONTROL LIMITED is registered under class 7 and 42 of the Trademark Act. Further, any kind of negative publicity or misuse of our brand name and our logo could hamper our brand building efforts and our future growth strategy could be adversely affected. Although, we believe that that our present systems are adequate to protect our confidential information and intellectual property, there can be no assurance that our intellectual property data, trade secrets or proprietary technology will not be copied, infringed or obtained by third parties. Further, our efforts to protect our intellectual property may not be adequate and may lead to erosion of our business value and our operations could be adversely affected. This may lead to litigations and any such litigations could be time consuming and costly and their outcome cannot be guaranteed. We believe that our future growth and competitiveness would depend on our ability to establish and strengthen our brand. Our Company may not be able to detect any unauthorized use or take appropriate and timely steps to enforce or protect our intellectual property, which may adversely affect our business, financial condition and results of operations. For further details pertaining to our intellectual property, please refer to the chapter titled “*Our Business*” beginning on page no 89 of this Draft Prospectus.

25. Our cost of production is exposed to fluctuations in the prices of raw materials required for the manufacture as well as its availability.

Our company is exposed to fluctuations in the prices of various raw materials like Nickel- Aluminum- Bronze (NAB), Copper- Nickel (CUNI), Copper- Aluminum (CUAL), and Titanium as well as its availability, particularly as we typically do not enter into any supply agreements with our suppliers and all the above-mentioned raw materials are bought by our Company from suppliers on an order to order basis. The prices of the various raw materials used in our manufacturing process are subject to fluctuations in the prices due to changes in core prices of minerals as a natural resource etc. Also, we procure some of the raw materials from international markets and the prices of these raw materials may fluctuate based on exchange rate, customs & duties levied on imports or changes in government policies with respect to these materials or the countries supplying the same. We may be unable to make adequate provisions for the price fluctuations and, consequently, any adverse fluctuations that we have not factored in or provided for may adversely affect the consolidated results of our operations and our consolidated financial conditions. We also face the risks associated with compensating for or passing on such increase in our cost of production on account of such fluctuations in prices to our customers. These factors could adversely affect our business, results of operations, financial condition and cash flows.

26. If we are unable to manage our growth effectively or raise additional capital, our business, future financial performance and results of operations could be materially and adversely affected.

The success of our business will depend greatly on our ability to effectively implement our business and growth strategy. As part of our growth strategy, we aim to, among other things. For details, see “Our Business – Our Business Strategy” on page 89. This could place significant demands on our operational, credit, financial and other internal risk controls. In pursuing our growth strategy, we will require additional capital investments and cash outlays, which may have a material impact on our cash flows and results of.

Our ability to manage our growth effectively requires us to forecast accurately our sales, growth and manufacturing capacity and to expand funds to improve our operational, financial and management controls, reporting systems and procedures. Moreover, even if we secure the required funding, there is no assurance that we will be able to successfully implement our strategies. We may also face difficulties in effectively implementing new technologies required in designing, developing and manufacturing new products and solutions and may not be able to recover our investments. Many of our contracts contain performance obligations that require innovative design capabilities are technologically complex or involve developmental costs. An inability to implement our future business plan, manage our growth effectively or failure to secure the required funding on favorable terms or at all could have a material and adverse effect on our business, future financial performance and results of operations.

27. We have incurred indebtedness which exposes us to various risks which may have an adverse effect on our business and results of operations. We may also be unable to obtain future financing to fund our operations, expected capital expenditure and working capital requirements on favorable terms, or at all.

We have provided security in respect of loans / facilities availed by us from our lender bank by creating a charge over our movable and immovable properties. Details of secured borrowing for period ended September 30, 2024, financial year ended 2023-24, 2022-23 and 2021-22 are as below:

(Rs in lakhs)

Particulars	For the period ended September 30, 2024	For the year ended March 31, 2024	For the year ended March 31, 2023	For the year ended March 31, 2022
Secured Debt	2,002.20	2,347.90	2,435.28	868.96
Total Debt	2,002.20	2,347.90	4,589.52	1,659.17
Secured Debt as a % of Total Debt	100.00%	100.00%	53.06%	52.37%

In the event we default in repayment of the loans / facilities availed by us and any interest thereon, our properties may be subject to invocation/forfeiture by lenders, which in turn could have significant adverse effect on business, financial condition or results of operations.

Our level of indebtedness has important consequences to us, such as:

- affecting our credit rating;
- limiting our ability to borrow more money both now and in the future;
- Increasing our interest expenditure and adversely affecting our profitability.

Our business requires funding for capital expenditure and working capital requirements. The actual amount and timing of future capital expenditure may depend on several factors, among others, new opportunities, availability of land, regulatory approvals, regulatory changes, economic conditions, technological changes and market developments in our industry. Our sources of additional funding, if required, to meet our capital expenditure may include the incurrence of debt or the issue of equity or debt securities or a combination of both. If we decide to raise additional funds through the incurrence of debt, our interest and debt repayment obligations will increase, and could have a significant effect on our profitability and cash flows and we may be subject to additional covenants, which could limit our ability to access cash flows from operations.

In case there is insufficient cash flow to meet our working capital requirement or we are unable to arrange the same from other sources or there is delay in disbursement of arranged funds, or there is any increase in interest rate on our borrowings, it may adversely affect our operations and profitability. These factors may result in an increased amount of short-term borrowings. Continuous increase of our working capital requirements may have an adverse effect on our results of operations and financial condition. Further our ability to arrange for additional funds on acceptable terms is subject to a variety of uncertainties, including future results of operations, financial condition and cash flows; economic, political conditions and market scenario for our products; costs of financing, liquidity and overall condition of financial and capital markets in India; issuance of necessary business/government licenses, approvals and other risks associated with our businesses; and limitations on our ability to raise capital in capital markets and conditions of the Indian and other capital markets in which we may seek to raise funds. Any such inability to raise sufficient funds could have a material adverse effect on our business and results of operations.

28. *We have not made any alternate arrangements for working capital requirements for the Objects of the Issue. Further we have not identified any alternate source of financing the ‘Objects of the Issue’.*

Any shortfall in raising or meeting the same could adversely affect our growth plans, operations and financial performance. As on date, we have not made any alternate arrangements for our working capital requirement as per the Objects of the Issue. Over the period of time, we have met our capital requirements through Banks and Internal Accruals. Any shortfall in our net cash flows, internal accruals and our inability to raise institutional debt in future would result in us being unable to fund our working capital needs, which in turn may increase our financial costs, affect our liquidity, thus negatively affecting our financial condition and results of operations.

While we do not anticipate seeking additional financing in the immediate future as a part of our plan post the Offer, any additional equity financing may result in dilution to the holders of the Equity Shares. Further, additional debt financing may impose affirmative and negative covenants that restrict our freedom to operate our business along with additional cost. The working capital requirement of the Company as per Restated Financial Statement was ₹ 12,047.20 lakhs, ₹ 10,999.67 lakhs, ₹ 4,421.87 lakhs and ₹ 2,311.14 lakhs, for period ended September 30, 2024, Fiscal 2024, 2023 and 2022 respectively. The working capital as a percentage of total revenue was 150.53%, 102.94%, 62.57% and 49.19% for period ended September 30, 2024, Fiscals 2024, 2023 and 2022 respectively. Further we have not identified any alternate source of funding and hence any failure or delay on our part to raise money from this Issue or any shortfall in the Issue Proceeds may delay the implementation schedule and could adversely affect our growth plans. For further details please refer “*Objects of the Issue*” on page no 62 of this Draft Prospectus.

29. *We have not commissioned an industry report for the disclosures made in the section titled ‘Industry Overview’ and made disclosures on the basis of the data available on the internet and such data has not been independently verified by us.*

We have neither commissioned an industry report, nor sought consent from the quoted website source for the disclosures which need to be made in the section titled “*Industry Overview*” beginning on page 77 of this Draft Prospectus. We have made disclosures in the said chapter on the basis of the relevant industry related data available online for which relevant consents have not been obtained. We have not independently verified such data. We cannot assure you that any assumptions made are correct or will not change and, accordingly, our position in the market may differ from that presented in this Draft Prospectus. Further, the industry data mentioned in this Letter of Offer or sources from which the data has been collected are not recommendations to invest in our Company. Accordingly, investors should read the industry related disclosure in this Draft Prospectus in this context.

30. *Our Promoters Sunil Menon and Gautam Makker has extended personal guarantees in connection with certain of our debt facilities.*

There can be no assurance that such personal guarantees will be continued to be provided by our Promoters in the future or can be called at any time, affecting the financial. Our Company is susceptible to changes in interest rates and the risks arising there from. Our latest sanction letters dated March 30, 2024 provide for interest at variable rates with a provision for the periodic resetting of interest rates. Further the lenders are entitled to change the applicable rate of interest, which is a combination of a base rate that depends upon the policies of the RBI and a contractually agreed spread, and in the event of an adverse change in our Company's credit risk rating.

For further details of interest payable on our borrowings, please refer to the chapter titled "*Financial Indebtedness*" on page no 170 of this Draft Prospectus Further, in recent years, the Government of India have taken measures to control inflation, which have included tightening the monetary policy by raising interest rates. As such, any increase in interest rates may have an adverse effect on our business, results of operations, cash flows and financial condition

31. ***Any disruption to the steady and regular supply of workforce for our operations, including due to strikes, work stoppages or increased wage demands by our workforce or any other kind of disputes with our workforce or our inability to control the composition and cost of our workforce could adversely affect our business, cash flows and results of operations.***

Our activities are human intensive, require our management to undertake significant labour interface, and expose us to the risk of industrial action. As on September 30, 2024, we had 237 permanent employees. We may be subject to industrial unrest, slowdowns, and increased wage costs, which may adversely affect our business, financial conditions, cash flows and results of operations. While we consider our relationship with our employees to be good and there has been no such instance in the three Fiscals of any disruptions in work due to disputes or other problems with our work force, we could experience disruptions in work due to disputes or other problems with our work force in future, which may adversely affect our ability to perform our business operations.

32. ***Our ability to pay dividends in the future will depend upon our future earnings, financial condition, cash flows, working capital requirements, capital expenditure and restrictive covenants in our financing arrangements.***

Our Company had declared a final dividend of Re. 1.00 per equity share (including interim dividend of Rs. 0.50 per equity share) in its Annual General Meeting held on 30th September 2024 in relation to financial year ending on 31st March 2024. Our Company has declared dividend. We may retain all our future earnings, if any, for use in the operations and expansion of our business. As a result, we may not declare dividends in the foreseeable future. Any future determination as to the declaration and payment of dividends will be at the discretion of our Board of Directors and will depend on factors that our Board of Directors deem relevant, including among others, our results of operations, financial condition, cash requirements, business prospects and any other financing arrangements.

Additionally, under some of our loan agreements, we may not be permitted to declare any dividends, if there is a default under such loan agreements or unless our Company has paid all the dues to the lender up to the date on which the dividend is declared or paid or has made satisfactory provisions thereof. Accordingly, realization of a gain on shareholders investments may largely depend upon the appreciation of the price of our Equity Shares. There can be no assurance that our Equity Shares will appreciate in value. For details of our dividend history, see "*Dividend Policy*" beginning on page 139 of this Draft Prospectus.

33. ***Our Company is subject to risk arising from changes in interest rates and banking policies.***

Increased interest rates will have a bearing on profitability and credit controls will have an effect on our liquidity and will have serious effects on adequate working capital requirements. We are dependent on various banks for arranging of our working capital requirement etc. Accordingly, any change in the existing banking policies or increase in interest rates may have an adverse impact on profitability of our company.

34. ***If inflation were to rise in India, we might not be able to increase the prices of our services at a proportional rate in order to pass costs on to our customers and our profits might decline.***

Inflation rates in India have been volatile in recent years, and such volatility may continue in the future. India has experienced high inflation in the recent past. Increased inflation can contribute to an increase in interest rates and increased costs to our business, including increased costs of transportation, wages, raw materials and other expenses relevant to our business. High fluctuations in inflation rates may make it more difficult for us to accurately estimate or control our costs. Any increase in inflation in India can increase our expenses, which we may not be able to pass on to our customers, whether entirely or in part, and may adversely affect our business, cash flows and financial condition. In particular, we might not be able to reduce our costs or increase the amount of commission to pass the increase in costs on to our customers. In such case, our business, results of operations, cash flows and financial condition may be

adversely affected. Further, the Government of India has previously initiated economic measures to combat high inflation rates, and it is unclear whether these measures will remain in effect. There can be no assurance that Indian inflation levels will not worsen in the future.

35. ***We may, from time to time, look for opportunities to enter strategic alliances, acquire businesses or enter into joint venture arrangements. Any failure to manage the integration of the businesses or facilities post such acquisition or joint venture may cause our profitability to suffer.***

We may, from time to time, look for opportunities to acquire businesses or enter into strategic partnerships or alliances. Such acquisitions may not contribute to our profitability, and we may be required to incur or assume debt or additional expenses beyond our forecasts or assume contingent liabilities, as part of any acquisition. Further, the acquisitions may give rise to unforeseen contingent risks relating to these businesses that may only become apparent after the merger or the acquisition is finalized. We may also face difficulty in assimilating and retaining the personnel, operations and assets of the acquired company. Further, we may not be able to accurately identify or forge an alliance with appropriate companies in line with our growth strategy. In the event that the alliance does not perform as estimated, or the inability on the part of our joint venture partner to meet the customer requirements may lead to a failure of such an arrangement which may adversely affect our business.

36. ***Failure to comply with environmental laws and regulations by us could lead to unforeseen environmental litigation which could impact our business and our future net earnings.***

We are subject to various national, state, municipal and local laws and regulations concerning environmental protection in India, including laws addressing the discharge of pollutants into the air and water, the management and disposal of any hazardous substances and wastes and the clean-up of contaminated sites. Environmental laws and regulations in India are becoming more stringent, and the scope and extent of new environmental regulations, including their effect on our operations, cannot be predicted with any certainty. In case of any change in environmental or pollution regulations, we may be required to further invest in, among other things, environmental monitoring, pollution control equipment, and emissions management. Further, any violation of the environmental laws and regulations may result in fines, criminal sanctions, revocation of operating permits, or shutdown of our manufacturing plants.

As a consequence of unanticipated regulatory or other developments, future environmental and regulatory related expenditures may vary substantially from those currently anticipated. While we have not faced any regulatory actions for non-compliance of environmental laws, we cannot assure you that in future our costs of complying with current and future environmental laws and other regulations will not adversely affect our business, results of operations or financial condition. In addition, we could incur substantial costs, our products could be restricted from entering certain markets, and we could face other sanctions, if we were to violate or become liable under environmental laws or if our products become non-compliant with applicable regulations. Our potential exposure includes fines and civil or criminal sanctions, third-party property damage or personal injury claims and clean-up costs. The amount and timing of costs under environmental laws are difficult to predict. For further information, see “*Key Regulations and Policies in India*” on page 107 of this Draft Prospectus.

37. ***We could be harmed by employee misconduct or errors that are difficult to detect and any such incidences could adversely affect our financial condition, results of operations and reputation.***

Employee misconduct or errors could expose us to business risks or losses, including regulatory sanctions and cause serious harm to our reputation. There can be no assurance that we will be able to detect or deter such misconduct. Moreover, the precautions we take to prevent and detect such activity may not be effective in all cases. Our employees and agents may also commit errors that could subject us to claims and proceedings for alleged negligence, as well as regulatory actions on account of which our business, financial condition, results of operations and goodwill could be adversely affected.

38. ***Investors can be subject to Indian taxes arising out of capital gains on the sale of the Equity Shares***

Under current Indian tax laws, capital gains arising from the sale of equity shares within 12 months in an Indian company are classified as short term capital gains and generally taxable. Any gain realized on the sale of listed equity shares on a stock exchange that are held for more than 12 months is considered as long-term capital gains and is taxable at 10%, in excess of ₹ 1,00,000. Any long-term gain realized on the sale of equity shares, which are sold other than on a recognized stock exchange and on which no STT has been paid, is also subject to tax in India. Capital gains arising from the sale of equity shares are exempt from taxation in India where an exemption from taxation in India is provided under a treaty between India and the country of which the seller is resident. Generally, Indian tax treaties do not limit

India's ability to impose tax on capital gains. As a result, residents of other countries may be liable to pay tax in India as well as in their own jurisdiction on a gain on the sale of equity shares.

39. *The ability of Indian companies to raise foreign capital may be constrained by Indian law.*

As an Indian Company, we are subject to exchange controls that regulate borrowing in foreign currencies, including those specified under FEMA. Such regulatory restrictions limit our financing sources for our projects under development and hence could constrain our ability to obtain financing on competitive terms and refinance existing indebtedness. In addition, we cannot assure you that the required approvals will be granted to us without onerous conditions, or at all. Limitations on foreign debt may adversely affect our business growth, results of operations and financial condition.

40. *Any downgrading of India's debt rating by a domestic or international rating agency could adversely affect our Company's business.*

Any adverse revisions to India's credit ratings for domestic and international debt by domestic or international rating agencies may adversely affect our Company's ability to raise additional financing, and the interest rates and other commercial terms at which such additional financing is available. This could harm our Company's business and financial performance and ability to obtain financing for capital expenditures.

41. *Conditions in the Indian securities market and stock exchanges may affect the price and liquidity of our Equity Shares.*

Indian stock exchanges, which are smaller and more volatile than stock markets in developed economies, have in the past, experienced problems which have affected the prices and liquidity of listed securities of Indian companies. These problems include temporary exchange closures to manage extreme market volatility, broker defaults, settlement delays and strikes by brokers. In addition, the governing bodies of the Indian stock exchanges have from time to time restricted securities from trading, limited price movements and restricted margin requirements. Further, disputes have occurred on occasion between listed companies and the Indian stock exchanges and other regulatory bodies that, in some cases, have had a negative effect on market sentiment. If similar problems occur in the future, the market price and liquidity of the Equity Shares could be adversely affected. Further, a closure of, or trading stoppage on, either of the Stock Exchanges could adversely affect the trading price of our Equity Shares.

42. *Our stock price may be highly volatile after the Issue and, as a result, you could lose a significant portion or all of your investment.*

Our Equity Shares are listed on the BSE-SME Stock Exchange and any trading closures at the Stock Exchanges may adversely affect the trading price of our Equity Shares. Further, we cannot predict the extent to which investor interest will lead to the development of an active trading market on the Stock Exchanges or how liquid that market will become.

If an active market does not develop, you may experience difficulty selling the Equity Shares that you purchased. The Issue Price is not indicative of prices that will prevail in the open market following the Issue. Consequently, you may not be able to sell your Equity Shares at prices equal to or greater than the Issue Price. The market price of the Equity Shares on the Stock Exchanges may fluctuate after listing as a result of several factors, including the following:

- Volatility in the Indian and other Global Securities Markets;
- The performance of the Indian and Global Economy;
- Risks relating to our business and industry, including those discussed in this Draft Prospectus;
- Strategic actions by us or our competitors;
- Investor perception of the investment opportunity associated with our future performance;
- Adverse media reports about us, our shareholders or Group Companies;
- Future sales of the Equity Shares;
- Variations in our half-yearly results of operations;
- Differences between our actual financial and operating results and those expected by investors and analysts;
- Our future expansion plans;
- Perceptions about the performance of companies engaged in defence sector generally;
- Perception in the market about investments in the Defence sector;
- Significant developments in the regulation of the trading and distribution industry in our key trade locations;
- Changes in the estimates of our performance or recommendations by financial analysts;
- Significant developments in India's economic liberalization and deregulation policies; and
- Significant developments in India's fiscal and environmental regulations.

There has been significant volatility in the Indian stock markets in the recent past, and our Equity Share. Price could fluctuate significantly as a result of market volatility. A decrease in the market price of the Equity Shares could cause you to lose some or all of your investment.

43. Pursuant to listing of the Equity shares, we may be subject to pre-emptive surveillance measures like Additional Surveillance Measures (“ASM”) and Graded Surveillance Measures (“GSM”) by the Stock Exchanges in the order to enhance market integrity and safeguard the interest of the investors.

On and post the listing of equity shares, we may be subject to ASM and GSM by the Stock Exchange(s) and the Securities and Exchange Board of India. These measures have been introduced in order to enhance market integrity, and safeguard the interest of investors and to alert and advise investors to be extra cautious and carry out necessary due diligence while dealing in such securities.

The criteria for shortlisting any scrip trading on the Stock Exchange(s) under the ASM is based on an objective criteria as jointly decided by SEBI and the Stock Exchange(s) which include market based dynamic parameters such as high low variations, client concentration, close to close price variation, market capitalization, volume variation, delivery percentage, number of unique PANs and price to equity ratio. A scrip is typically subjected to GSM measures where there is an abnormal price rise that is not commensurate with the financial health and fundamentals of a company which inter alia includes factors like earnings, book value, fixed assets and net worth to the equity ratio etc. The price of our equity shares may also fluctuate after the Issue due to several factors such as volatility in the Indian and global securities market, our profitability and performance, the performance of our competitors, change in the estimates of our performance or any other political or economic factor. The occurrence of any of the above-mentioned factors may trigger the parameters identified by SEBI and the Stock Exchange(s) for the placing securities under the GSM and ASM framework. In the event of our Equity Shares are covered under such Pre-emptive surveillance measures implemented by SEBI and the Stock Exchange(s), we may be subject to certain additional restrictions in the relation to trading of our Equity Shares such as limiting trading frequency (for example trading either allowed in a week or a month) higher margin requirements of settlement on a trade for trade basis without netting off requirement of settlement on gross basis or freezing price on upper side of trading which may have an adverse effect on the market price of our Equity Shares or may in general cause disruptions in the development of an active market for and trading and liquidity of our Equity Shares and on the reputation and conditions of our Company.

EXTERNAL RISKS

44. Our business is substantially affected by prevailing economic, political and other prevailing conditions in India and globally.

Our Company is incorporated in India, and our manufacturing operations are located in India. Our business and results of operations have been and continue to be affected by international, national and regional economic conditions. Unfavourable economic conditions in India or any of our key markets could have a material adverse effect on our business, results of operations, financial condition and prospects. As a result, we are highly dependent on prevailing economic conditions in India and the other key markets and our results of operations and cash flows are significantly affected by factors influencing the economy in India and such key markets. Factors that may adversely affect the economy in such countries, and hence our results of operations and cash flows, may include:

- any adverse change in the growth rate of the global economy;
- any increase in interest rates or inflation;
- any exchange rate fluctuations;
- any scarcity of credit or other financing, resulting in an adverse impact on economic conditions and scarcity of financing for our expansions;
- prevailing income conditions among consumers and corporates;
- volatility in, and actual or perceived trends in trading activity on, the relevant market’s principal stock exchanges;
- changes in tax, trade, fiscal or monetary policies, including import restrictions;
- political instability, terrorism or military conflict in the region or globally, including in various neighbouring countries;
- occurrence of natural or man-made disasters;
- prevailing regional or global economic conditions, including in the relevant country’s principal export markets;
- any downgrading of debt rating by a domestic or international rating agency;
- instability in financial markets; and

- other significant regulatory or economic developments in or affecting the relevant country.

In particular, rates of economic growth have significant impacts on our consumers of steel and intermediate products, such as the automotive, infrastructure and the construction industries and declines in steel consumption caused by poor or unfavorable economic conditions in one or more of our major markets or by the deterioration of the financial condition of our key customers would have a material adverse effect on demand for our products and hence on our business and results of operations.

45. *Restrictions on the import of our materials and other regulations could adversely affect our business, results of operations and financial condition.*

We design and manufacture many defence products considered to be of national strategic interest. Limitation or withdrawal, if any (in the case, for example, of embargoes or geopolitical conflicts), of the authorization to import the products might have a negative impact on our operations and financial situation. Further, failure to comply with the regulations and requirements could result in contract modifications or termination and the imposition of penalties, fines and withdrawal of authorizations, which could negatively affect our business, results of operations and financial condition. Authorizations can be revoked which may change in response to international conflicts or other political or geopolitical factors. Such factors could have a material adverse effect on our business and results of operations.

46. *Political, economic or other factors that are beyond our control may have an adverse effect on our business and results of operations.*

The Indian economy and its securities markets are influenced by economic developments and volatility in securities markets in other countries. Investors' reactions to developments in one country may have adverse effects on the market price of securities of companies located elsewhere, including India. Adverse economic developments, such as rising fiscal or trade deficit, in other emerging market countries may also affect investor confidence and cause increased volatility in Indian securities markets and indirectly affect the Indian economy in general. Any of these factors could depress economic activity and restrict our access to capital, which could have an adverse effect on our business, financial condition and results of operations and reduce the price of our Equity Shares. Any financial disruption could have an adverse effect on our business, future financial performance, shareholders' equity and the price of our Equity Shares.

We are dependent on domestic, regional and global economic and market conditions, where some of our revenue from operations is generated. Our performance, growth and market price of our Equity Shares are and will be dependent to a large extent on the health of the economy in which we operate. There have been periods of slowdown in the economic growth of India. Demand for our products may be adversely affected by an economic downturn in domestic and regional economies. Economic growth in the countries in which we operate is affected by various factors including domestic consumption and savings, balance of trade movements, namely export demand and movements in key imports, global economic uncertainty and liquidity crisis, volatility in exchange currency rates. Consequently, any future slowdown in the Indian economy could harm our business, results of operations and financial condition. Also, a change in the government or a change in the economic and deregulation policies could adversely affect economic conditions prevailing in the areas in which we operate in general and our business in particular and high rates of inflation in India could increase our costs without proportionately increasing our revenues, and as such decrease our operating margins.

47. *Natural or man-made disasters, fires, epidemics, pandemics, acts of war, terrorist attacks, civil unrest and other events could materially and adversely affect our business.*

Natural disasters (such as typhoons, flooding and earthquakes), epidemics, pandemics such as COVID-19 and man-made disasters, including acts of war, terrorist attacks and other events, many of which are beyond control, may lead to economic instability, including in India or globally, which may in turn materially and adversely affect our business, financial condition and results of operations. Our operations may be adversely affected by fires, natural disasters and/or severe weather, which can result in damage to our property or inventory and generally reduce our productivity and may require us to evacuate personnel and suspend operations. Any terrorist attacks or civil unrest as well as other adverse social, economic and political events in India or states to whom we sell our products could have a negative effect on us. Further, the ongoing Russia-Ukraine conflict may also have adverse impact on our supply chain. However, the long-term risks associated with the conflict is not clear as of the date of this Prospectus. Such incidents could also create a greater perception that investment in Indian companies involves a higher degree of risk and could have an adverse effect on our business and the price of the Equity Shares. A number of countries in Asia, including India, as well as countries in other parts of the world, are susceptible to contagious diseases and, for example, have had confirmed cases of diseases such as the highly

pathogenic H7N9, H5N1 and H1N1 strains of influenza in birds and swine and more recently, the COVID-19 virus. A worsening of the current outbreak of COVID-19 pandemic or future outbreaks of COVID-19 virus or a similar contagious disease could adversely affect the global economy and economic activity in the region. As a result, any present or future outbreak of a contagious disease could have a material adverse effect on our business and the trading price of the Equity Shares.

48. *Changing regulations in India could lead to new compliance requirements that are uncertain.*

The regulatory and policy environment in which our Company operate is evolving and subject to change. Our business and financial performance could be adversely affected by unfavourable changes in or interpretations of existing, or the promulgation of new, laws, rules and regulations applicable to the Company and our business. In such instances, and including the instances mentioned below, our business, results of operations and prospects may be adversely impacted, to the extent that our Company is unable to suitably respond to and comply with any such changes in applicable law and policy. Any political instability in India, such as corruption, scandals and protests against certain economic reforms, which have occurred in the past, could slow the pace of liberalization and deregulation. The rate of economic liberalization could change, and specific laws and policies affecting foreign investment, currency exchange rates and other matters affecting investment in India could change as well.

Additionally, the Government of India has introduced (a) the Code on Wages, 2019; (b) the Code on Social Security, 2020; (c) the Occupational Safety, Health and Working Conditions Code, 2020; and (d) the Industrial Relations Code, 2020 which consolidate, subsume and replace numerous existing central labour legislations. While the rules for implementation under these codes have not been notified, the implementation of such laws could increase our employee and labour costs, thereby adversely impacting our results of operations, cash flows, business and financial performance.

The application of various Indian tax laws, rules and regulations to our business, currently or in the future, is subject to interpretation by the applicable taxation authorities. For instance, companies can voluntarily opt in favour of a concessional tax regime (subject to no other special benefits/exemptions being claimed), which reduces the rate of income tax payable to 22% subject to compliance with conditions prescribed, from the erstwhile 25% or 30% depending upon the total turnover or gross receipt in the relevant period. Any such future amendments may affect our other benefits such as exemption for income earned by way of dividend from investments in other domestic companies and units of mutual funds, exemption for interest received in respect of tax-free bonds, and long-term capital gains on equity shares if withdrawn by the statute in the future, and the same may no longer be available to us. Any adverse order passed by the appellate authorities/ tribunals/ courts would have an effect on our profitability.

Further, the GoI has announced the union budget for Fiscal 2024, pursuant to which the Finance Bill, 2023 (“Finance Bill”), has introduced various amendments. The Finance Bill has received assent from the President of India on March 31, 2023, and has been enacted as the Finance Act, 2023. Our Company cannot predict whether any amendments made pursuant to the Finance Act, 2023 would have an adverse effect on our business, financial condition and results of operations. Furthermore, changes in capital gains tax or tax on capital market transactions or the sale of shares could affect investor returns. As a result, any such changes or interpretations could have an adverse effect on our business and financial performance.

There can be no assurance that the GoI will not implement new regulations and policies requiring the Company to obtain approvals and licenses from the GoI or other regulatory bodies or impose onerous requirements and conditions on our operations. Any such changes and the related uncertainties with respect to the applicability, interpretation and implementation of any amendment or change to governing laws, regulation or policy, including by reason of an absence, or a limited body, of administrative or judicial precedent in the jurisdictions in which our Company operate may be time consuming as well as costly for the Company to resolve and may impact the viability of our current business or restrict our ability to grow our business in the future. It may also have a material

adverse effect on our business, financial condition, cash flows and results of operations. In addition, our Company may have to incur expenditures to comply with the requirements of any new regulations, which could materially harm our results of operations or cash flows. Any unfavourable changes to the laws and regulations applicable to the Company could also subject to the additional liabilities on the Company.

Our Company is unable to determine the impact of any changes in or interpretations of existing, or the promulgation of, new, laws, rules and regulations applicable to the Company and its business. If that was to occur it could result in the Company, our business, operations or group structure being deemed to be in contravention of

such laws and/or may require it to apply for additional approvals. Our Company may incur increased costs and other burdens relating to compliance with such new requirements, which may also require significant management time and other resources, and any failure to comply may adversely affect our business, results of operations and prospects. Uncertainty in the applicability, interpretation or implementation of any amendment to, or change in, governing law, regulation or policy, including by reason of an absence, or a limited body, of administrative or judicial precedent may be time consuming as well as costly for the Company to resolve and may impact the viability of our current business or restrict our ability to grow our business in the future.

49. ***A downgrade in ratings of India, may affect the trading price of the Equity Shares.***

Our borrowing costs and our access to the debt capital markets depend significantly on the credit ratings of India. Any further adverse revisions to India's credit ratings for domestic and international debt by international rating agencies may adversely impact our ability to raise additional financing and the interest rates and other commercial terms at which such financing is available, including raising any overseas additional financing. A downgrading of India's credit ratings may occur, for example, upon a change of government tax or fiscal policy, which are outside our control. This could have an adverse effect on our ability to fund our growth on favourable terms or at all, and consequently adversely affect our business and financial performance and the price of the Equity Shares.

50. ***A third-party could be prevented from acquiring control of us post this Issue, because of anti-takeover provisions under Indian Law.***

As a listed Indian entity, there are provisions in Indian law that may delay, deter or prevent a future takeover or change in control of our Company. Under the Takeover Regulations, an acquirer has been defined as any person who, directly or indirectly, acquires or agrees to acquire shares or voting rights or control over a company, whether individually or acting in concert with others. Although these provisions have been formulated to ensure that interests of investors/shareholders are protected, these provisions may also discourage a third party from attempting to take control of our Company subsequent to completion of the Issue. Consequently, even if a potential takeover of our Company would result in the purchase of the Equity Shares at a premium to their market price or would otherwise be beneficial to our shareholders, such a takeover may not be attempted or consummated because of Takeover Regulations.

51. ***Civil disturbances, extremities of weather, regional conflicts and other political instability may have adverse effects on our operations and financial performance.***

Certain events that are beyond our control such as earthquake, fire, floods and similar natural calamities may cause interruption in the business undertaken by us. Our operations and financial results and the market price and liquidity of our equity shares may be affected by changes in Indian Government policy or taxation or social, ethnic, political, economic or other adverse developments in or affecting India.

SECTION IV: INTRODUCTION

THE ISSUE

This Offer has been authorised through a resolution passed by our Board at its meeting held on September 05, 2024 and by the shareholders of the Company in the EGM held on September 30, 2024 pursuant to Sections 23 and 62 of the Companies Act, 2013.

The following is a summary of this Issue, and should be read in conjunction with and is qualified entirely by, the information detailed in the chapter titled “*Terms of the Offer*” on page 194 of this Draft Prospectus.

The following is the summary of the Issue:

Equity Shares Offered through Further Public Issue	Upto 15,00,000 Equity Shares of face value of ₹ 10 each for cash at a price of ₹ [●] per Equity Share aggregating ₹ [●] lakhs
Consisting of:	
Fresh Issue⁽¹⁾	Upto 15,00,000 Equity Shares of face value of ₹ 10 each for cash at a price of ₹ [●] per Equity Share aggregating ₹ [●] lakhs
Which Comprises:	
Market Maker Reservation Portion	Upto [●] Equity Shares of face value of ₹10 each for cash at a price of ₹ [●] per Equity Share aggregating ₹ [●] lakhs.
Net Issue to Public⁽²⁾	Upto 12,48,000 Equity Shares of face value of ₹ 10 each for cash at a price of ₹ [●] per Equity Share aggregating ₹ [●] lakhs.
	Of which⁽³⁾:
	Upto [●] Equity Shares of ₹ 10 each at a price of ₹ [●] per Equity Share will be available for allocation for Investors of upto ₹ 2.00 lakhs
	Upto [●] Equity Shares of ₹ 10 each at a price of ₹ [●] per Equity Share will be available for allocation for Investors of above ₹ 2.00 lakhs
Equity shares outstanding prior to the Issue	1,94,74,100 Equity Shares of face value of ₹10 each
Equity shares outstanding after the Issue	Upto 2,09,74,100 Equity Shares of face value of ₹10 each
Use of Net Proceeds	Please refer to the section titled “ <i>Objects of the Issue</i> ” beginning on page no. 62 of this Draft Prospectus.

*Assuming Full Allotment

Notes:

- 1) *The Issue is being made in terms of Regulations 103(1), 104 and 129(1) for the FPO, as amended from time to time.*
- 2) *This Issue is being made in terms of Section IX of the SEBI (ICDR) Regulations 2018, as amended from time to time. The Issue is being made through the Fixed Price method and hence, as per Regulation 281 read with section 129(4) of SEBI (ICDR) Regulations, the allocation in the net issue to public category shall be made as follow:*

a) Minimum fifty percent to retail individual investors; and

b) Remaining to

(i) Individual applicants other than retail individual investors; and

(ii) Other investors including corporate bodies or institutions, irrespective of the number of specified securities applied for :

The unsubscribed portion in either of the categories specified in (a) or (b) above may be allocated to the applicants in the other category.

If the retail individual investor category is entitled to more than fifty per cent on proportionate basis, accordingly the retail individual investors shall be allocated that higher percentage.

For further details of the Composite Issue, see “*Issue Procedure*” on page 205.

SUMMARY OF FINANCIAL INFORMATION

The following tables provide the summary of financial information of our Company derived from the Restated Financial Information as at and for the Period ended September 30, 2024 and Financial Years ended March 31, 2024, 2023 and 2022.

ANNEXURE I - RESTATED FINANCIAL STATEMENT OF ASSETS AND LIABILITIES

(₹ in Lakhs)

Particulars	For the period ended September 30, 2024	As at March 31, 2024	As at March 31, 2023	As at March 31, 2022
EQUITY AND LIABILITIES				
Shareholder's Fund				
Equity share capital	1,947.41	1,947.41	1,427.41	71.37
Reserves and Surplus	11,953.45	10,646.20	1,071.52	1,413.96
Total Equity	13,900.86	12,593.61	2,498.93	1,485.33
Non-Current Liabilities				
Long term Borrowings	577.36	639.06	3,025.41	1,104.48
Long term Provisions	31.49	14.70	10.52	7.69
Total Non-Current Liabilities	608.86	653.76	3,035.92	1,112.17
Current Liabilities				
Short term borrowing	1,418.77	1,708.84	1,564.11	554.69
Trade Payables				
- Total outstanding dues of micro enterprises and small enterprises	-	-	-	-
- Total outstanding dues of others	1,099.14	243.62	933.91	1,961.07
Other Current Liabilities	541.36	458.65	471.57	237.45
Short-term Provisions	907.45	457.46	363.56	244.99
Total Current Liabilities	3,966.71	2,868.56	3,333.15	2,998.20
Total Equity and Liabilities	18,476.42	16,115.94	8,868.00	5,595.70
ASSETS				
Non-Current Assets				
Property, Plant & Equipment	2,855.46	3,016.70	2,628.39	812.91
Intangible Assets	911.39	4.84	-	-
Intangible Assets under development	-	849.33	-	-
Deferred tax Assets	26.29	29.48	3.00	7.65
Other non-current assets	88.12	56.19	45.68	20.50
Total Non-Current Assets	3,881.26	3,956.54	2,677.08	841.05
Current Assets				
Inventories	5,796.14	5,268.18	3,727.78	2,083.36
Trade Receivables	5,210.00	882.30	813.31	1,314.39
Cash and Cash Equivalents	416.83	1,727.32	157.91	405.28
Short-term Loans and Advances	2,177.71	3,287.26	834.88	829.46
Other Current Assets	994.47	993.94	657.05	122.15
Total Current Assets	14,595.16	12,159.40	6,190.93	4,754.64
Total Assets	18,476.42	16,115.94	8,868.00	5,595.70

ANNEXURE II - RESTATED FINANCIAL STATEMENT OF PROFIT AND LOSS
(₹ in Lakhs)

Particulars	For the period ended September 30, 2024	As at March 31, 2024	As at March 31, 2023	As at March 31, 2022
REVENUE				
Revenue from Operations	8,003.41	10,685.91	7,066.63	4,698.77
Other Income	18.40	11.66	43.31	13.62
Total Income	8,021.81	10,697.57	7,109.94	4,712.39
EXPENSES				
Cost of material consumed	4,782.86	6,397.09	4,633.30	3,197.20
Employee Benefit Expenses	491.91	413.80	251.06	96.35
Finance cost	105.92	239.97	311.07	124.83
Depreciation & Amortization Expenses	289.41	445.26	131.95	90.79
Other Expenses	443.09	801.31	340.97	159.28
Prior period expenses	-	-	1.80	6.63
Total Expenses	6,113.18	8,297.42	5,670.14	3,675.08
Exceptional items	-	-	-	-
Profit/(Loss) Before Tax	1,908.63	2,400.15	1,439.80	1,037.31
Less: Provision for Tax				
Current Tax	480.25	700.00	383.00	265.00
Deferred Tax	3.20	(26.49)	4.65	(0.50)
Short/Excess Tax provision for earlier period	20.57	17.85	38.55	(0.07)
Total tax	504.02	691.37	426.20	263.99
Profit for the year	1,404.61	1,708.78	1,013.60	773.32
Earnings per share (Face Value 10)*				
Basic	7.21	9.21	7.10	5.42
Diluted	7.21	9.21	7.10	5.42

**Not Annualised*

ANNEXURE III- CASH FLOW STATEMENT, AS RESTATED
(₹ in Lakhs)

Particulars	For the period ended September 30, 2024	As at March 31, 2024	As at March 31, 2023	As at March 31, 2022
CASH FLOW FROM OPERATING ACTIVITIES				
Net Profit/(Loss) before tax	1,908.63	2,400.15	1,439.80	1,037.31
<u>Adjustments</u>				
Depreciation	289.41	445.26	131.95	90.79
Provision for Gratuity	17.84	4.33	2.95	8.39
Foreign Exchange fluctuation (Gain)/ Loss	(7.64)	6.66	(35.33)	2.10
Interest income	(10.77)	(11.66)	(7.98)	(10.45)
Balance written off	-	-	-	(3.18)
Finance cost	105.92	239.97	311.07	124.83
Operating profit before working capital adjustment	2,303.29	3,084.70	1,842.45	1,249.79
Adjustment for changes in working capital				
Trade and other payable	863.16	(696.96)	(983.33)	1,358.50
Other current liabilities	(14.65)	(12.93)	234.12	(410.57)
Short-term provision	-	(8.50)	-	-
Short-term Loans & Advances	1,109.95	(2,452.78)	(5.42)	(592.83)
Trade and other receivables	(4,327.70)	(68.99)	501.08	(654.28)
Inventories	(527.96)	(1,540.40)	(1,644.43)	(78.33)
Other Current Assets	(0.54)	(336.89)	(534.89)	97.65
Other Non-Current Assets	(31.93)	(27.04)	(25.18)	(20.50)
Cash flow from operations	(626.29)	(2,059.78)	(615.59)	949.42
Less: Direct tax paid	(51.88)	(615.59)	(311.61)	(29.74)
Net Cash Flow from Operating Activities	(678.18)	(2,675.37)	(927.20)	919.69
CASH FLOW FROM INVESTING ACTIVITIES				
Purchases of fixed assets (including intangibles)	(185.39)	(1,671.19)	(1,947.44)	-
Interest received	10.77	11.66	7.98	10.45
Net Cash Flow from Investing Activities	(174.63)	(1,659.53)	(1,939.46)	10.45
CASH FLOW FROM FINANCING ACTIVITIES				
Proceed from short term borrowings	(290.07)	144.73	1,009.42	(688.88)
Proceed from long term borrowings	(61.69)	(2,386.35)	1,920.93	86.84
Finance cost	(105.92)	(239.97)	(311.07)	(124.83)
Issue of share capital	-	8,483.28	-	-
Dividend	-	(97.37)	-	-
Net Cash Flow from Financing Activities	(457.68)	5,904.32	2,619.28	(726.87)
Net change in Cash and Cash Equivalents	(1,310.49)	1,569.42	(247.37)	203.27
Cash and Cash Equivalents at the beginning of the year	1,727.32	157.97	405.28	202.01
Cash and Cash Equivalents at the end of the year	416.84	1,727.33	157.91	405.28

The Restated Financial Information referred to above is presented under the section titled “Financial Information” beginning on Page No. 140 of this Draft Prospectus. The summary of financial information presented below should be read in conjunction with the Restated Financial Information, the notes thereto and the chapters titled “Financial Information” and “Management’s Discussion and Analysis of Financial Position and Results of Operations” beginning on Page Nos. 140 and 159, respectively of this Draft Prospectus.

GENERAL INFORMATION

Our Company was incorporated as Flash Forge Fluid Control Private Limited on February 16, 2012 under the Companies Act, 1956 with the Registrar of Companies, Mumbai, Maharashtra bearing Registration number 227023. The name of our company was changed to CFF Fluid Control Private Limited vide Special resolution dated September 21, 2012. The fresh certificate of incorporation consequent of name change was issued on October 19, 2012 by the Registrar of Companies, Mumbai, Maharashtra. Further the status of the Company was changed to Public limited and the name of our Company was changed to CFF Fluid Control Limited vide Special Resolution dated September 05, 2022. The fresh certificate of incorporation consequent to conversion was issued on September 15, 2022 by the Registrar of Companies, Mumbai, Maharashtra. The Corporate Identification Number of our Company is U28990MH2012PLC227023. For further details pertaining to the change of name of our Company and the change in Registered Office, please refer the chapter “History and Certain Corporate Matters” on page no. 116 of this Draft Prospectus

REGISTERED OFFICE OF OUR COMPANY

CFF FLUID CONTROL LIMITED

Registered Office: Plot No 01, Survey No 96, Kumbhivli Madap Khopoli, Khalapur, Raigarh-410203.

Tel No.: +91-2246086806

Email ID: compliance@cffdefensys.com

Website: www.cffdefensys.com

CORPORATE OFFICE OF OUR COMPANY

Corporate Office:- 503, Delphi, A Wing, Orchard Avenue, Hiranandani Business Park, Powai, Mumbai-400076.

Tel No.: +91-2246086806

Email ID: compliance@cffdefensys.com

Website: www.cffdefensys.com

REGISTRAR OF COMPANIES

Our Company is registered with the Registrar of Companies, Mumbai situated at the following address:

Address: 100, Everest, Marine Drive, Mumbai 400 002

Tel No: +91- 22- 2281 2627 / 2202 0295/ 2284 6954

Website: www.mca.gov.in

DESIGNATED STOCK EXCHANGE

SME Platform of BSE Limited (“BSE SME”)

P. J. Towers, Dalal Street,

Fort, Mumbai – 400 001

Website: www.bseindia.com

BOARD OF DIRECTORS OF OUR COMPANY

Set forth below are the details of our Board of Directors as on the date of this Draft Prospectus

Name	Designation	DIN	Residential Address
Sunil Menon	Managing Director	00409485	Flat No. 501, A Wing, Adonia Hiranandani Garden, Powai IIT, Powai Mumbai, Maharashtra-400076.
Gautam Makker	Chairman and Non-Executive Director	00354956	805-806, Prathima Estate, Paradise Isle, Maharanipeta, Visakhapatnam (Urban), Visakhapatnam, Andhra Pradesh -400067.
Priyanka Moondra Rathi	Non-Executive Independent Director	09485101	Plot No. 16/2 B, Bhatti ki Bavri, Chopasni Housing Board, Jodhpur Nandanwan Jodhpur, Rajasthan-342008
Prakash Rajnish	Non-Executive Independent Director	08595423	C/502, Haware Tiara Building, Plot No. 184, Sector 13, Kharghar, Navi Mumbai, Raigarh, Maharastra -410210.

For detailed profile of our Directors, please refer to the chapter titled “*Our Management*” on page 120 of the Draft Prospectus.

CHIEF FINANCIAL OFFICER

Hitesh Birla

503, Delphi, A Wing,

Orchard Avenue,

Hiranandani Business Park,

Powai, Mumbai-400076.

Tel No.: +91-2246086806

Email ID: compliance@cffdefensys.com

COMPANY SECRETARY AND COMPLIANCE OFFICER

Sonika Mehta

503, Delphi, A Wing,

Orchard Avenue,

Hiranandani Business Park,

Powai, Mumbai-400076.

Tel No.: +91-2246086806

Email ID: compliance@cffdefensys.com

LEAD MANAGER TO THE ISSUE



ARYAMAN FINANCIAL SERVICES LIMITED

60, Khatau Building, Ground Floor

Alkesh Dinesh Modi Marg

Opp. P. J. Towers (BSE Building),

Fort, Mumbai – 400 001

Tel No.: +91 – 22 – 6216 6999

Email: ipo@afsl.co.in

For Investor Grievances: feedback@afsl.co.in

Website: www.afsl.co.in

Contact Person: Vatsal Ganatra

SEBI Registration No.: INM000011344

STATEMENT OF INTER-SE ALLOCATION OF RESPONSIBILITIES OF THE LM

Our Company will comply with the SEBI ICDR Regulations and any other directions issued by SEBI in relation to this Offer. In this regard, our Company has appointed the LM to manage and procure this Issue. Aryaman Financial Services Limited is the sole Lead Manager to the Issue and all the responsibilities relating to co-ordination and other activities in relation to the Issue shall be performed by them and hence a statement of inter-se allocation of responsibilities is not required.

INVESTOR GRIEVANCES

Investor are advised to contact the Company Secretary and Compliance Officer and/or the Registrar to the Issue in case of any pre-Issue or post-Issue related grievances such as non-receipt of letters of Allotment, non-credit of Allotted Equity Shares in the respective beneficiary account, non-receipt of refund orders, non-receipt of funds by electronic mode, etc. For all Issue-related queries and for redressal of complaints, Investors may also write to the Lead Manager.

All grievances may be addressed to the Registrar to the Issue with a copy to the relevant Designated Intermediary with whom the Application Form was submitted, giving full details such as name of the sole or First Applicant, Application Form number, Applicant’s DP ID, Client ID, PAN, address of Applicant, number of Equity Shares applied for, ASBA Account number in which the amount equivalent to the Application Amount was blocked or the UPI ID (for UPI Investors who make the payment of Application Amount through the UPI Mechanism), date of Application Form and the name and address of the relevant Designated Intermediary where the Application was submitted. Further, the Applicant shall enclose the Acknowledgment Slip or the application number from the Designated Intermediary in addition to the documents or information mentioned hereinabove.

In terms of SEBI circular SEBI/HO/CFD/DIL2/CIR/P/2021/2480/1/M dated March 16, 2021, as amended pursuant to SEBI circular SEBI/HO/CFD/DIL2/P/CIR/2021/570 dated June 2, 2021 and SEBI circular no. SEBI/HO/CFD/DIL2/CIR/P/2022/51 dated April 20, 2022 and subject to applicable law, any ASBA Applicant whose Application has not been considered for Allotment, due to failure on the part of any SCSB, shall have the option to seek redressal of the same by the concerned SCSB within three months of the date of listing of the Equity Shares. SCSBs are required to resolve these complaints within 15 days, failing which the concerned SCSB would have to pay interest at the rate of 15% per annum for any delay beyond this period of 15 days. Further, the post Offer lead manager is required to compensate the investor for delays in grievance redressal from the date on which the grievance was received until the actual date of unblock.

Further, the Applicant shall also enclose a copy of the Acknowledgment Slip or provide the acknowledgement number received from the Designated Intermediaries in addition to the information mentioned hereinabove. All grievances relating to Applications submitted through Registered Brokers may be addressed to the Stock Exchanges with a copy to the Registrar to the Issue. The Registrar to the Issue shall obtain the required information from the SCSBs for addressing any clarifications or grievances of ASBA Applicants.

FILING OF OFFER DOCUMENT

This Draft Prospectus is being filed with the SME Platform of BSE Limited (“BSE SME”), P. J. Towers, Dalal Street, Fort, Mumbai – 400 001. This Draft Prospectus shall not be filed with SEBI, nor will SEBI issue any observation on the Offer Document in terms of Regulation 246 of the SEBI ICDR Regulations. However, pursuant to Sub Regulation 25(8) of SEBI ICDR Regulations and pursuant to SEBI Circular Number SEBI/HO/CFD/DIL1/CIR/P/2018/011 dated January 19, 2018, a copy of the Draft Prospectus will be filed online through SEBI Intermediary Portal at <https://siportal.sebi.gov.in>.

Further, in accordance with Regulation 246(1), a copy of the Offer Document along with the Material Contracts and Material Documents referred elsewhere in this Draft Prospectus as required to be filed under Section 26 of the Companies Act, 2013 will be delivered to the Registrar of Companies, 100, Everest, Marine Drive, Mumbai 400 002, within the timeline specified under the applicable law.

Details of Key Intermediaries pertaining to this Issue of our Company:

REGISTRAR TO THE ISSUE



CAMEO CORPORATE SERVICES LIMITED

Subramanian Building, No. 1, Club House Road,
Chennai – 600 002.

Tel.: +91 - 44 -40020700 (5 Lines)

E-mail: priya@cameoindia.com

Investor Grievance Email: investor@cameodina.com

Website: www.cameoindia.com

Contact Person: Ms. K. Sreepriya

SEBI Registration. No.: INR 000003753

LEGAL ADVISOR TO THE ISSUE

M/S. ABDUS SAMEE ABDUL QADIR MANIYAR (A. A. MANIYAR) (ADVOCATE)

Office No. 2-A, Ground Floor, Ali Chambers, Tamarind Street,
Fort, Mumbai 400 001

Tel No.: +91 – 79 –26447527

Contact Person: +91 – 22 - 2265 5505

Email: advaamaniyar@gmail.com

MARKET MAKER



ARYAMAN CAPITAL MARKETS LIMITED

60, Khatau Building, Ground Floor Alkesh Dinesh
Modi Marg Opp. P. J. Towers (BSE Building),
Fort, Mumbai - 400 001

Tel. No.: +91 - 22 - 6216 6999

Email: aryacapm@gmail.com
Contact Person: Mr. Harshad Dhanawade
SEBI Registration No.: SMMM0651421122012

Details of the Market Making Arrangement for this Issue

Our Company and the Lead Manager, have entered into an agreement dated January 17, 2023 with Market Maker registered with SME Platform of BSE Limited in order to fulfill the obligations of Market Making

The Market Maker shall fulfill the applicable obligations and conditions as specified in the SEBI (ICDR) Regulations, and its amendments from time to time and the circulars issued by the BSE and SEBI regarding this matter from time to time.

STATUTORY AUDITOR OF OUR COMPANY

M/s. V. N. Purohit & CO., Chartered Accountants

214, New Delhi House, 2nd Floor,
 27, Barakhamba, New Delhi-110001

Tel: +011-43596011

Email: vnpdelhi@gmail.com

Contact Person: O. P. Pareek

Membership No.: 014238

Firm Registration No.: 304040E

Peer Review No: 012784

CHANGES IN THE AUDITORS

Except as disclosed below, there has been no change in the statutory auditors during the three years immediately preceding the date of this Draft Prospectus:

Sr. No.	Date of Change	From	To	Reason for change
1.	September 05, 2022	M/s. Chandiramani & Co. Chartered Accountants Shop No. 85, 1st Floor, Heera Panna Mall, Oshiwara, Andheri (West), Mumbai, Maharashtra- 400053. Tel: 022 – 40165545/46 Email: info@cncindia.com Contact Person: Mohan Chandiramani Peer Review No.: N. A. Membership No.: 040127 Firm Registration No.: 101667W	M/s. V. N. Purohit & CO., Chartered Accountants 214, New Delhi House, 2 nd Floor, 27, Barakhamba, New Delhi-110001 Tel: +011-43596011 Email: vnpdelhi@gmail.com Contact Person: O. P. Pareek Membership No.: 014238 Firm Registration No.: 304040E Peer Review No: 012784	Appointment of Peer Review certified Auditor

BANKERS TO OUR COMPANY

[•]

BANKER(S) TO THE ISSUE / REFUND BANK / SPONSOR BANK

[•]

DESIGNATED INTERMEDIARIES

Self-Certified Syndicate Banks

The list of banks that have been notified by SEBI to act as SCSBs for the ASBA process is provided at the website of the SEBI <https://www.sebi.gov.in/sebiweb/other/OtherAction.do?doRecognised=yes> and updated from time to time. For details on Designated Branches of SCSBs collecting the Application Forms, refer to the website of the SEBI <https://www.sebi.gov.in/sebiweb/other/OtherAction.do?doRecognised=yes>.

In accordance with SEBI Circular No. SEBI/HO/CFD/DIL2/CIR/P/2019/76 dated June 28, 2019 and SEBI Circular No. SEBI/HO/CFD/DIL2/CIR/P/2019/85 dated July 26, 2019, Retail Individual Investors Applying using the UPI Mechanism may apply through the SCSBs and mobile applications whose names appears on the website of the SEBI (<https://www.sebi.gov.in/sebiweb/other/OtherAction.do?doRecognisedFpi=yes&intmId=40>) and (<https://www.sebi.gov.in/sebiweb/other/OtherAction.do?doRecognisedFpi=yes&intmId=43>) respectively, as updated from time to time.

SCSBs enabled for UPI Mechanism

In accordance with SEBI Circular No. SEBI/HO/CFD/DIL2/CIR/P/2019/76 dated June 28, 2019 and SEBI Circular No. SEBI/HO/CFD/DIL2/CIR/P/2019/85 dated July 26, 2019, Retail Individual Investors Applying using the UPI Mechanism may apply through the SCSBs and mobile applications whose names appears on the website of the SEBI (<https://www.sebi.gov.in/sebiweb/other/OtherAction.do?doRecognisedFpi=yes&intmId=40>) and updated from time to time. A list of SCSBs and mobile applications, which are live for applying in public issues using UPI mechanism is provided as 'Annexure A' for the SEBI circular number SEBI/HO/CFD/DIL2/CIR/P/2019/85 dated July 26, 2019, as amended.

Registered Brokers

The list of the Registered Brokers, including details such as postal address, telephone number and e-mail address, is provided on the website of the Stock Exchange, at BSE Limited at <https://www.bseindia.com/> as updated from time to time.

Registrar and Share Transfer Agent

The list of the RTAs eligible to accept ASBA Forms at the Designated RTA Locations, including details such as address, telephone number and e-mail address, is provided on the website of BSE Limited at <https://www.bseindia.com/> as updated from time to time.

Collecting Depository Participants

The list of the Collecting Depository Participants (CDPs) eligible to accept Application Forms at the Designated CDP Locations, including details such as name and contact details, are provided at <https://www.sebi.gov.in/sebiweb/other/OtherAction.do?doRecognisedFpi=yes&intmId=19> for NSDL CDPs and at <https://www.sebi.gov.in/sebiweb/other/OtherAction.do?doRecognisedFpi=yes&intmId=18> for CDSL CDPs, as updated from time to time. The list of branches of the SCSBs named by the respective SCSBs to receive deposits of the Bid cum Application Forms from the Designated Intermediaries will be available on the website of the SEBI (www.sebi.gov.in) and updated from time to time.

FPO GRADING

Since the Issue is being made in terms of Chapter IX of the SEBI (ICDR) Regulations, 2018 there is no requirement of appointing an FPO Grading agency.

CREDIT RATING

As this is an Issue of Equity Shares, credit rating is not required.

GREEN SHOE OPTION

No Green Shoe Option is applicable for this Issue.

BROKERS TO THE ISSUE

All members of the recognized stock exchanges would be eligible to act as Brokers to the Issue.

DEBENTURE TRUSTEES

As this is an Issue of Equity Shares, the appointment of Debenture trustees is not required.

MONITORING AGENCY

As the Net Proceeds of the Issue will be less than ₹10,000 lacs, under the SEBI ICDR Regulations, it is not required that a monitoring agency be appointed by our Company.

APPRAISING ENTITY

None of the objects for which the Net Proceeds will be utilised have been appraised by any agency.

EXPERT OPINION

Except as stated below, our Company has not obtained any expert opinions:

Our Company has received written consent from the Statutory Auditor namely, M/s. V.N. Purohit & Co, Chartered Accountants, to include their name as required under Section 26(1)(a)(v) of the Companies Act, 2013 in this Draft Prospectus and as “Expert” as defined under section 2(38) of the Companies Act, 2013 in respect to their Report on Restated Financial Statements dated November 05, 2024 and Report on Statement of Tax Benefits dated November 05, 2024 and issued by them, included in this Draft Prospectus and such consent has not been withdrawn as on the date of this Draft Prospectus.

However, the term “expert” shall not be construed to mean an “expert” as defined under the U.S. Securities Act.

INTER-SE ALLOCATION OF RESPONSIBILITIES

Aryaman Financial Service Limited, being the sole Lead Manager will be responsible for all the responsibilities related to co-ordination and other activities in relation to the. Hence, a statement of inter se allocation of responsibilities is not required.

FILING OF ISSUE DOCUMENT

The Draft Prospectus and Prospectus shall be filed on SME Platform of BSE Limited.

Pursuant to Securities and Exchange Board of India (Issue of Capital and Disclosure Requirements) (Amendment) Regulations, 2022, Draft Prospectus has not been submitted to SEBI, however, soft copy of Prospectus shall be submitted to SEBI pursuant to SEBI Circular Number SEBI/HO/CFD/DIL1/CIR/P/2018/011 dated January 19, 2018, through SEBI Intermediary Portal at <https://siportal.sebi.gov.in>. SEBI will not issue any observation on the issue document in term of Regulation 246(2) of the SEBI ICDR Regulations.

A copy of the Prospectus along with the material contracts and documents required to be filed under Section 26 of the Companies Act, 2013 will be delivered to the Registrar of Companies, Mumbai situated at 100, Everest, Marine Drive, Mumbai- 400 002, Maharashtra, India at least (3) three working days prior from the date of opening of the Issue.

ISSUE PROGRAMME

Event	Dates
Issue Opening Date	[●]
Issue Closing Date	[●]
Finalization of Basis of Allotment with the Designated Stock Exchange	[●]
Initiation of Allotment / Refunds / Unblocking of Funds	[●]
Credit of Equity Shares to demat accounts of Allottees	[●]
Commencement of trading of Equity Shares on the Stock Exchange	[●]

The above timetable is indicative and does not constitute any obligation on our Company, or the Lead Manager. Whilst our Company shall ensure that all steps for the completion of the necessary formalities for the listing and the commencement of trading of the Equity Shares on the Stock Exchange are taken within 3 Working Days of the Issue Closing Date, the timetable may change due to various factors, such as extension of the Issue Period by our Company, or any delays in receiving the final listing and trading approval from the Stock Exchange. The Commencement of trading of the Equity Shares will be entirely at the discretion of the Stock Exchange and in accordance with the applicable laws.

Applications and any revision to the same shall be accepted only between **10.00 a.m. and 5.00 p.m.** (IST) during the Issue Period (except for the Issue Closing Date). On the Issue Closing Date, the Applications and any revision to the same shall be accepted between **10.00 a.m. and 3.00 p.m.** (IST) or such extended time as permitted by the Stock Exchanges, in case of Applications by Retail Individual Investor after taking into account the total number of applications received upto the closure of timings and reported by the Lead Manager to the Stock Exchanges. It is clarified that Applications not uploaded on the electronic system would be rejected. Applications will be accepted only on Working Days, i.e., Monday to Friday (excluding any public holiday).

Due to limitation of time available for uploading the Applications on the Issue Closing Date, the Applicants are advised to submit their Applications one day prior to the Issue Closing Date and, in any case, no later than 3.00 p.m. (IST) on the Issue Closing Date. All times mentioned in this Draft Prospectus are Indian Standard Times. Applicants are cautioned that in the event a large number of Applications are received on the Issue Closing Date, as is typically experienced in public offerings, some Applications may not get uploaded due to lack of sufficient time. Such

Applications that cannot be uploaded will not be considered for allocation under the Issue. Applications will be accepted only on Business Days. Neither our Company, nor the Lead Manager is liable for any failure in uploading the Applications due to faults in any software/hardware system or otherwise.

In accordance with the SEBI Regulations, QIBs and Non-Institutional Applicants are not allowed to withdraw or lower the size of their Applications (in terms of the quantity of the Equity Shares or the Applications Amount) at any stage. Retail Individual Investor can revise or withdraw their Applications prior to the Issue Closing Date. Except Allocation to Retail Individual Investors, Allocation in the Issue will be on a proportionate basis.

In case of discrepancy in the data entered in the electronic book vis-à-vis the data contained in the physical or the electronic Application Form, for a particular Applicant, the details as per the file received from the Stock Exchange may be taken as the final data for the purpose of Allotment. In case of discrepancy in the data entered in the electronic book vis-à-vis the data contained in the physical or electronic Application Form, for a particular ASBA Applicant, the Registrar to the Issue shall ask the relevant SCSB or the member of the Syndicate for rectified data.

WITHDRAWAL OF THE ISSUE

Our Company in consultation with the Lead Manager, reserves the right not to proceed with the Issue at any time after the Issue Opening Date but before the Board meeting for Allotment. In such an event our Company would Issue a public notice in the newspapers, in which the pre- Issue advertisements were published, within two days of the Issue Closing Date or such other time as may be prescribed by SEBI, providing reasons for not proceeding with the Issue. The Lead Manager, through the Registrar to the Issue, shall notify the SCSBs to unblock the bank accounts of the ASBA Applicants within one day of receipt of such notification. Our Company shall also promptly inform the Stock Exchange on which the Equity Shares were proposed to be listed. Notwithstanding the foregoing, the Issue is also subject to obtaining the final listing and trading approvals of the Stock Exchange, which our Company shall apply for after Allotment. If our Company withdraws the Issue after the Issue Closing Date and thereafter determines that it will proceed with an IPO, our Company shall be required to file a fresh Draft Prospectus. Notwithstanding the foregoing, the Issue is subject to obtaining (i) the final listing and trading approvals of the Stock Exchange with respect to the Equity Shares Issued through the Prospectus, which our Company will apply for only after Allotment; and (ii) the final RoC approval of the Prospectus.

UNDERWRITING AGREEMENT

The Company and the Lead Manager to the Issue hereby confirm that the Issue will be 100% Underwritten by the Underwriters [•].

Pursuant to the terms of the Underwriting Agreement dated [•] entered into by Company, Underwriters, the obligations of the Underwriters are subject to certain conditions specified therein. The Details of the Underwriting commitments are as under:

Details of the Underwriters	No. of shares underwritten*	Amount Underwritten (₹ in Lakh)	% of the total Issue Size Underwritten
[•]	[•]	[•]	[•]

*Includes [•] Equity shares of ₹10.00 each for cash of ₹ [•]/- the Market Maker Reservation Portion which are to be subscribed by the Market Maker in its own account in order to claim compliance with the requirements of Regulation 261 of the SEBI (ICDR) Regulations, as amended.

In the opinion of our Board of Directors (based on a certificate given by the Underwriter), the resources of the above-mentioned Underwriter is sufficient to enable it to discharge its underwriting obligation in full. The above mentioned Underwriter is registered with SEBI under Section 12(1) of the SEBI Act and registered as brokers with the Stock Exchanges.

CAPITAL STRUCTURE

The Equity Share Capital of the Company as on the date of this Draft Prospectus and after giving effect to the Issue is set forth below:

(₹ in lakhs, except share data)

Sr. No.	Particulars	Aggregate Value at Face Value	Aggregate Value at Issue Price
A.	Authorized Share Capital		
	2,10,00,000 Equity Shares of face value of ₹ 10 each	2,100.00	-
B.	Issued, Subscribed and Paid-Up Equity Capital before the Issue		
	1,94,74,100 Equity Shares of face value of ₹ 10 each	1,947.41	-
C.	Present Issue in Terms of this Draft Prospectus		
	Issue of 15,00,000 Equity Shares of face value of ₹ 10 each ⁽¹⁾	150.00	[●]
	<i>Which Comprises:</i>		
	Reservation for Market Maker portion		
	[●]* Equity Shares of Rs. 10/- each at a price of Rs. [●] per Equity Share reserved as Market Maker Portion	[●]	[●]
	Net Issue to the Public		
	Net Issue to Public of [●]* Equity Shares of Rs. 10/- each at a price of Rs. [●] per Equity Share to the Public	[●]	[●]
	<i>Of which⁽²⁾</i>		
	[●]* Equity Shares of Rs. 10/- each at a price of Rs. [●] per Equity Share will be available for allocation for Investors of up to Rs. 2.00 lakhs	[●]	[●]
	[●]* Equity Shares of Rs. 10/- each at a price of Rs. [●] per Equity Share will be available for allocation for Investors of above Rs. 2.00 lakhs	[●]	[●]
D.	Paid-up Equity Capital after the Issue		
	2,09,74,100 Equity Shares of face value of ₹ 10 each		2,097.41
E.	Securities Premium Account		
	Before the Issue		Nil
	After the Issue**		[●]

**To be included upon finalisation of the FPO Price and Rights Issue Price*

***Subject to finalisation of Basis of Allotment, Allotment and deduction of Offer expenses*

(1) The present Issue has been authorized by our Board pursuant to a resolution passed at its meeting held on September 05, 2024 and by our Shareholders pursuant to a Special Resolution passed at the Annual General Meeting held on September 30, 2024.

(2) Allocation to all categories shall be made on a proportionate basis subject to valid Applications received at or above the Issue Price. Under subscription, if any, in any of the categories, would be allowed to be met with spill-over from any of the other categories or a combination of categories at the discretion of our Company in consultation with the Lead Manager and Designated Stock Exchange. Such inter-se spill over, if any, would be affected in accordance with applicable laws, rules, regulations and guidelines.

CLASS OF SHARES

Our Company has only one class of share capital i.e., Equity Shares of ₹10/-each. All Equity Shares issued are fully paid-up. Our Company has no outstanding convertible instruments as on the date of this Draft Prospectus.

NOTES TO THE CAPITAL STRUCTURE

1. Changes In Authorized Share Capital

Since incorporation, the capital structure of our Company has been altered in the following manner:

1. The Initial Authorized Share Capital shares of ₹ 100,000 (One Lakhs) divided into 10,000 (Ten Thousand) Equity Shares of ₹ 10 each to ₹ 100,00,000 (One Crore) divided into 10,00,000 (Ten Lakhs) Equity Shares of ₹ 10 each pursuant to Shareholders Resolution passed at the Extra Ordinary General Meeting held on September 21, 2012.
2. The Authorized Share Capital of the Company was increase from ₹100,00,000 (One Crore) divided into 10,00,000 (Ten Lakhs) Equity Shares of ₹ 10 each to ₹ 20,00,00,000 (Twenty Crore) divided into 2,00,00,000 (Two Crore) Equity Shares of ₹ 10 each pursuant to Shareholders Resolution passed at the Extra Ordinary General Meeting held on July 07, 2022.
3. The Authorized Share Capital of the Company was increase from ₹ 20,00,00,000 (Twenty Crore) divided into 2,00,00,000 (Two Crore) Equity Shares of ₹ 10 each to ₹ 21,00,00,000 (Twenty One Crore) divided into 2,10,00,000 (Two Crore Ten Lakhs) Equity Shares of ₹ 10 each pursuant to Shareholders Resolution passed at the Extra Ordinary General Meeting held on November 25, 2022.

2. Share Capital History of our Company

The following table sets forth the history of the equity share capital of our Company:

Date of Allotment of Equity Shares	No. of Equity Shares	Face Value (₹)	Issue Price (₹)	Nature / Reason of Allotment	Nature of Consideration	Cumulative No. of Equity Shares	Cumulative Paid Up Share Capital (₹)	Cumulative Share Premium (₹)
On Incorporation	10,000	10	10	Subscription to MoA ⁽¹⁾	Cash	10,000	1,00,000	Nil
August 22, 2013	1,85,527	10	50	Rights Issue ⁽²⁾	Cash	1,95,527	19,55,270	74,21,080
April 08, 2015	88,178	10	50	Private Placement ⁽³⁾	Cash	2,83,705	28,37,050	1,09,48,200
November 21, 2015	4,30,000	10	50	Rights Issue ⁽⁴⁾	Cash	7,13,705	71,37,050	2,81,48,200
July 11, 2022	1,35,60,395	10	NA	Bonus Issue ⁽⁵⁾	Other than Cash	1,42,74,100	14,27,41,000	Nil
June 07, 2022	52,00,000	10	165	Initial Public Offer	Cash	1,94,74,100	19,47,41,000	80,60,00,000

⁽¹⁾Initial Subscribers to the Memorandum of Association, the Company issue and allotted 9,999 Equity Shares to Flash Forge Private Limited and 1 Equity share allotted to Sunil Menon.

⁽²⁾Pursuant to the Right Issue of the Equity shares, the Company issued and allotted 1,34,690 shares to Flash Forge Private Limited and 50,837 shares to Financiere MB Sas.

⁽³⁾Pursuant to the Private Placement of the Equity shares, the Company issued and allotted 88,178 shares to Financiere MB Sas.

⁽⁴⁾Pursuant to the Right Issue of the Equity shares, the Company issued and allotted 4,30,000 shares to Flash Forge Private Limited.

⁽⁵⁾Pursuant to the Bonus Issue of the Equity shares, the Company issued and allotted 1,35,60,395 Equity shares of Face Value of Rs. 10/- each in the ratio 19:1 i.e 19 Bonus Equity shares for every 1 Equity Share held as per the details given below:

<i>Sr. No.</i>	<i>Name of Allottees</i>	<i>Number of Shares Allotted</i>
1.	Sunil Menon	67,79,827
2.	Gautam Makker	41,38,523
3.	SheeilaMakker	16,75,382
4.	NiranjanMakker	9,65,903
5.	Hitesh Birla	190
6.	Manisha Varma	190
7.	Nayya Birla	190
8.	Vijay Kumar Kalavala	190
	Total	1,35,60,395

⁽⁶⁾The Company allotted 52,00,000 Equity Shares of face value of ₹ 10/- each in the Initial Public Offer to the successful allottees.

3. Details of Equity Shares issued for consideration other than cash:

Except as set out below, we have not issued Equity Shares for consideration other than cash:

Date of Allotment	Name of the Allottees	No. of Equity Shares	Face Value (₹)	Issue Price (₹)	Reasons for allotment	Benefits accrued to our Company
July 2022	Sunil Menon	67,79,827	10	N.A.	Other than cash	Bonus Issue - Expansion of Capital
	Gautam Makker	41,38,523				
	SheeilaMakker	16,75,382				
	NiranjanMakker	9,65,903				
	Hitesh Birla	190				
	Manisha Varma	190				
	Nayya Birla	190				
	Vijay Kumar Kalavala	190				
	Total	1,35,60,395				

- No shares have been allotted in terms of any scheme approved under sections 230-234 of the Companies Act, 2013.
- Our Company has not issued any shares pursuant to an Employee Stock Option Scheme.
- No shares have been issued at a price lower than the Issue Price within the last one year from the date of the Draft Prospectus except as mentioned under:

Date of Allotment	Name of the Allottees	No. of Equity Shares	Face Value (₹)	Issue Price (₹)	Reasons for allotment	Benefits accrued to our Company
July 2022	Sunil Menon	67,79,827	10	N.A.	Other than cash	Bonus Issue - Expansion of Capital
	Gautam Makker	41,38,523				
	SheeilaMakker	16,75,382				
	NiranjanMakker	9,65,903				
	Hitesh Birla	190				
	Manisha Varma	190				
	Nayya Birla	190				
	Vijay Kumar Kalavala	190				
	Total	1,35,60,395				

Category (I)	Category of shareholder(II)	Nos. of shareholders (III)	No. of fully paid up equity shares held (IV)	No. of Partly paid-up equity shares held (V)	No. of shares underlying Depository Receipts (VI)	Total nos. shares held (VII) = (IV)+(V)+(VI)	Shareholding as a % of total no. of shares (calculated as per SCRR, 1957) (VIII) As a % of (A+B+C2)	Number of Voting Rights held in each class of securities (IX)				No. of Underlying Outstanding convertible securities (including Warrants) (X)	Shareholding, as a % assuming full convertible securities (as a percentage of diluted share capital) (XI)= (VII)+(X) As a % of (A+B+C2)	Number of Locked in shares (XII)		Number of Shares pledged or otherwise encumbered (XIII)		Number of equity shares held in dematerialized form (XIV)
								No of Voting Rights			Total as a % of (A+B+C)			No (a)	As a % of total Shares held (b)	No (a)	As a % of total Shares held (b)	
								Class-Equity	Class	Total								
A	Promoter & Promoter Group	4	1,42,74,900	-	-	1,42,74,900	73.30%	1,42,74,900	-	1,42,74,900	73.30%	-	73.30%	39,00,000	20.02%	-	-	1,42,74,900
B	Public	3504	51,99,200	-	-	51,99,200	26.70%	51,99,200	-	51,99,200	26.70%	-	26.70%	-	-	-	-	51,99,200
C	Non Promoter Non Public	-	-	-	-	-	-	-	-	-	-	-	-	-	-	-	-	-
C1	Shares Underlying DRs	-	-	-	-	-	-	-	-	-	-	-	-	-	-	-	-	-
C2	Shares held by Employee Trusts	-	-	-	-	-	-	-	-	-	-	-	-	-	-	-	-	-
	Total	3508	1,94,74,100	-	-	1,94,74,100	100.00%	1,94,74,100	-	1,94,74,100	100.00%	-	100.00%	-	-	-	-	1,94,74,100

As on date of this Draft Prospectus 1 Equity Shares share holds 1 vote.

We have only one class of Equity Shares of face value of Rs. 10/- each.

We have entered into tripartite agreement dated June 24, 2024 with CDSL & May 15, 2024 with NSDL respectively

Our Company will file the shareholding pattern in the format prescribed under Regulation 31 of the SEBI (Listing Obligations and Disclosure Requirements), Regulations, 2015, one day prior to the listing of the Equity Shares. The shareholding pattern will be uploaded on the Website of the BSE before commencement of trading of such Equity Shares.

- a) Set forth below is a list of Shareholders holding 1% or more of the paid-up Share Capital of our Company as of two years prior to the date of this Draft Prospectus.

Sr. No.	Name of the Shareholder	Number of Equity shares	Percentage of the pre-Issue Equity Share capital (%)
1.	Sunil Menon	71,36,660	50.00%
2.	Gautam Makker	43,56,340	30.52%
3.	Niranjana Makker	10,16,740	7.12%
4.	Sheela Makker	17,63,560	12.35%
Total		1,42,73,300	99.99%

- b) Set forth below is a list of Shareholders holding 1% or more of the paid-up Share Capital of our Company as of one year prior to the date of this Draft Prospectus.

Sr. No.	Name of the Shareholder	Number of Equity shares	Percentage of the pre-Issue Equity Share capital (%)
1.	Sunil Menon	71,38,260	36.66%
2.	Gautam Makker	43,56,340	22.37%
3.	Sheela Makker	17,63,560	9.06%
4.	Niranjandev Makker	10,16,740	5.22%
5.	Tripurari Deal Trade Private Limited	5,94,400	3.05%
6.	Vedankit Traders Private Limited	3,93,600	2.02%
7.	Sappers Infra Realtors Private Limited	2,78,400	1.43%
8.	Morning Vinimay Private Limited	2,32,800	1.20%
Total		1,57,74,100	81.00%

- c) Set forth below is a list of Shareholders holding 1% or more of the paid-up Share Capital of our Company as of ten days prior to the date of this Draft Prospectus.

Sr. No.	Name of the Shareholder	No. of Shares	Percentage of Pre-Issue Share Capital (%)
1.	Sunil Menon	71,38,260	36.66%
2.	Gautam Makker	43,56,340	22.37%
3.	Sheela Makker	17,63,560	9.06%
4.	Niranjandev Makker	10,16,740	5.22%
5.	Tripurari Deal Trade Private Limited	4,02,000	2.06%
6.	Vedankit Traders Private Limited	3,60,800	1.85%
7.	Morning Vinimay Private Limited	2,32,800	1.20%
8.	Sappers Infra Realtors Private Limited	2,30,800	1.19%
Total		1,55,01,300	79.60%

- d) Set forth below is a list of Shareholders holding 1% or more of the paid-up Share Capital of our Company as on the date of this Draft Prospectus.

Sr. No.	Name of the Shareholder	No. of Shares	Percentage of Pre-Issue Share Capital (%)
1.	Sunil Menon	71,38,260	36.66%
2.	Gautam Makker	43,56,340	22.37%
3.	Sheela Makker	17,63,560	9.06%
4.	Niranjandev Makker	10,16,740	5.22%
5.	Tripurari Deal Trade Private Limited	4,02,000	2.06%
6.	Vedankit Traders Private Limited	3,60,800	1.85%
7.	Morning Vinimay Private Limited	2,32,800	1.20%
8.	Sappers Infra Realtors Private Limited	2,30,800	1.19%
Total		1,55,01,300	79.60%

- e) Our Company has made a public issue in Year 2023 and no further public issue (including any rights issue to the public) has been made after Initial Public Offer (IPO).
- f) Our Company has not issued any warrants, convertible debentures, loan or any other instrument which would entitle the shareholders to equity shares upon exercise or conversion.
7. Except as disclosed in this Draft Prospectus, our Company does not have any intention or proposal to alter our capital structure within a period of 6 months from the date of opening of the Issue by way of split/ consolidation of the denomination of Equity Shares or further issue of Equity Shares (including issue of securities convertible into exchangeable, directly or indirectly, for our Equity Shares) whether preferential or bonus, rights, further public issue or qualified institutions placement or otherwise. However, our Company may further issue Equity Shares (including issue of securities convertible into Equity Shares) whether preferential or otherwise after the date of the opening of the Issue to finance an acquisition, merger or joint venture or for regulatory compliance or such other scheme of arrangement or any other purpose as the Board may deem fit, if an opportunity of such nature is determined by its Board of Directors to be in the interest of our Company.

8. Shareholding of our Promoters

- a) Build-up of the shareholding of our Promoter

Date of Allotment / Transfer	Nature of Issue / Transaction	Nature of Consideration	No. of Equity Shares	FV (₹)	Acquisition / Transfer Price	% of Pre Issue Equity Share Capital	% of Post Issue Equity Share Capital
Sunil Menon							
On Incorporation	Subscription to MOA	Cash	1	10	10	Negligible%	[•]
September, 30, 2014	Transfer	Cash	(1)	10	50	Negligible%	[•]
November 21, 2015	Transfer	Cash	1	10	50	Negligible%	[•]
April 01, 2021	Transfer	Cash	2,55,000	10	110	1.31%	[•]
May 01, 2021	Transfer	Cash	1,01,867	10	110	0.52%	[•]
February 11, 2022	Transfer	Cash	(35)	10	110	Negligible%	[•]
July 07, 2022	Bonus Issue	Other than Cash	67,79,827	10	Nil	34.81%	[•]
June 26, 2023	On-Market Purchase	Cash	800	10	190.48	Negligible%	[•]
November 12, 2023	On-Market Purchase	Cash	800	10	467.94	Negligible%	[•]
Gautam Makker							
May 01, 2021	Transfer	Cash	2,17,822	10	110	1.12%	[•]
February 11, 2022	Transfer	Cash	(5)	10	110	Negligible%	[•]
July 07, 2022	Bonus Issue	Other than Cash	41,38,523	10	Nil	21.25%	[•]

9. Our Company has Three Thousand Three Hundred and Thirty Eight (3738) shareholders, as on the date of this Draft Prospectus.

10. We hereby confirm that:

- a. None of the members of the Promoter, Promoter Group, Directors and their immediate relatives have purchased or sold any Equity shares of our Company within the last six months from the date of this Draft Prospectus:

- b. None of the members of the Promoter Group, Directors and their immediate relatives have financed the purchase by any other person of Equity shares of our Company other than in the normal course of business of the financing entity within the period of six months immediately preceding the date of this Draft Prospectus.

11. Promoter’s Contribution and other Lock-in details

a) Details of Promoter’s Contribution locked-in for three (3) years

Pursuant to Regulation 236 and 238 of SEBI (ICDR) Regulations, 2018, an aggregate of 20.00% of the post issue capital held by our Promoters shall be considered as Promoter’s Contribution (“Promoters Contribution”) and shall be locked-in for a period of three years from the date of allotment of Equity Shares issued pursuant to this Issue. The lock in of Promoter’s Contribution would be created as per applicable law and procedure and details of the same shall also be provided to the Stock Exchange before listing of the Equity Shares.

As on the date of this Draft Prospectus, our Promoters collectively hold 1,14,94,600 Equity Shares constituting 54.80% of the Post – Issued, subscribed and paid up Equity Shares Share Capital of our Company, which are eligible for the Promoters’ contribution

The details of the Equity Shares held by our Promoter, which shall be locked-in for a period of three years from the date of allotment, are set out in the following table:

Name of Promoter	No. of Equity Shares Locked-in ⁽¹⁾	% of the post- Issue equity share capital
Sunil Menon	[•]	[•]
Gautam Makker	[•]	[•]
Total	[•]	[•]

⁽¹⁾For details on the date of Allotment of the above Equity Shares, the nature of Allotment, face value and the price at which they were acquired, please refer “Notes to Capital Structure” on page no. 53 of this Draft Prospectus

We confirm that in compliance with Regulation 237 of SEBI ICDR Regulations, the minimum Promoter contribution of 20% as shown above which is subject to lock-in for three years does not consist of:

- Equity Shares acquired during the preceding three years for consideration other than cash and out of revaluation of assets or capitalization of intangible assets or bonus shares out of revaluation reserves or reserves without accrual of cash resources.
- Equity Shares acquired by the Promoter during the preceding one year, at a price lower than the price at which Equity Shares are being issued to public in the Issue.
- The Equity Shares held by the Promoter and offered for minimum 20% Promoter’ Contribution is not subject to any pledge.
- Equity Shares for which specific written consent has not been obtained from the shareholders for inclusion of their subscription in the minimum Promoter’ Contribution subject to lock-in.

We further confirm that our Promoter’ Contribution of 20% of the Post Issue Equity does not include any contribution from Alternative Investment Funds or FVCI or Scheduled Commercial Banks or Public Financial Institutions or Insurance Companies.

a) Details of share capital locked-in for one (1) year

i) Pursuant to Regulation 238 (b) of the SEBI (ICDR) Regulations, in addition to the Promoter’s Contribution to be locked-in for a period of 3 years, as specified above, the entire Pre-Issue Equity Share capital will be locked in for a period of one (1) year from the date of Allotment in this Issue.

ii) Pursuant to Regulation 242 of the SEBI Regulations, the Equity Shares held by our Promoter can be pledged only with banks or financial institutions as collateral security for loans granted by such banks or financial institutions for the purpose of financing one or more of the objects of the Issue and the pledge of shares is one of the terms of sanction of such loan. However, as on date of this Draft Prospectus, none of the Equity Shares held by our Promoter have been pledged to any person, including banks and financial institutions.

- iii) Pursuant to Regulation 243 of the SEBI (ICDR) Regulations, Equity Shares held by our Promoter, which are locked in as per Regulation 238 of the SEBI (ICDR) Regulations, may be transferred to and amongst our Promoter / Promoter Group or to a new promoter or persons in control of our Company subject to continuation of the lock-in in the hands of the transferees for the remaining period and compliance with Securities and Exchange Board of India (Substantial Acquisition of Shares and Takeover) Regulations, 2011 as applicable.
- iv) Pursuant to Regulation 243 of the SEBI (ICDR) Regulations, Equity Shares held by shareholders other than our Promoter, which are locked-in as per Regulation 239 of the SEBI (ICDR) Regulations, may be transferred to any other person holding shares, subject to continuation of the lock-in in the hands of the transferees for the remaining period and compliance with Securities and Exchange Board of India (Substantial Acquisition of Shares and Takeover) Regulations, 2011 as applicable.
12. As on the date of this Draft Prospectus, the entire Issued Share, Subscribed and Paid-up Share Capital of our Company is fully paid up. Since the entire issue price in respect of the issue is payable on application, all the successful applicants will be allotted fully paid-up Equity Shares.
13. The LM i.e, Aryaman Financial Services Limited and their associates do not hold any Equity Shares in our Company as on the date of filing of this Draft Prospectus.
14. As on the date of this Draft Prospectus, we do not have any Employees Stock Option Scheme / Employees Stock Purchase Scheme and we do not intend to allot any shares to our employees under Employee Stock Option Scheme/ Employee Stock Purchase Plan from the proposed issue. As and when, options are granted to our employees under the Employee Stock Option Scheme, our Company shall comply with the SEBI (Share Based Employee Benefits) Regulations, 2014.
15. As on the date of filing of this Draft Prospectus, there are no outstanding warrants, options or rights to convert debentures, loans or other instruments which would entitle Promoters or any shareholders or any other person any option to acquire our Equity Shares after this Further Public Issue.
16. Our Company has not raised any bridge loan against the proceeds of the Issue.
17. As on the date of this Draft Prospectus, none of the shares held by our Promoters/ Promoter Group are subject to any pledge.
18. Except for Equity Shares pursuant to the Fresh Issue, our Company presently does not intend or propose to alter its capital structure for a period of six months from the Bid/Issue Opening Date, by way of split or consolidation of the denomination of Equity Shares, or by way of further issue of Equity Shares (including issue of securities convertible into or exchangeable, directly or indirectly for Equity Shares), whether on a preferential basis, or by way of issue of bonus Equity Shares, or on a rights basis, or by way of further public issue of Equity Shares, or otherwise. However, if our Company enters into acquisitions, joint ventures or other arrangements, our Company may, subject to necessary approvals, consider raising additional capital to fund such activity or use of Equity Shares as consideration for acquisitions or participations in such joint ventures.
19. There are no outstanding options or convertible securities, including any outstanding warrants or rights to convert debentures, loans or other instruments convertible into our Equity Shares as on the date of this Draft Prospectus.
20. We hereby confirm that there will be no further issue of capital whether by way of issue of bonus shares, preferential allotment, rights issue or in any other manner during the period commencing from the date of the Draft Prospectus until the Equity Shares offered have been listed or application money unblocked on account of failure of Issue.
21. An over-subscription to the extent of 10% of the Issue subject to the maximum post issue paid up capital of ₹ 25 cr. can be retained for the purpose of rounding off to the nearest integer during finalizing the allotment, subject to minimum allotment, which is the minimum application size in this Issue. Consequently, the actual allotment may go up by a maximum of 1% of the Issue, as a result of which, the post-issue paid up capital after the Issue would also increase by the excess amount of allotment so made. In such an event, the Equity Shares held by the Promoters and subject to 3-year lock- in shall be suitably increased; so as to ensure that 20% of the post Issue paid-up capital is locked in.

22. Under-subscription, if any, in any category, except in the QIB Portion, would be allowed to be met with spill over from any other category or a combination of categories at the discretion of our Company, in consultation with the LM and the Designated Stock Exchange. Such inter-se spill over, if any, would be effected in accordance with applicable laws, rules, regulations and guidelines. Under-subscription, if any, in the QIB Category will not be allowed to be met with spill over from any category or combination thereof.
23. In case of over-subscription in all categories the allocation in the issue shall be as per the requirements of Regulation 253 of SEBI (ICDR) Regulations, 2018 and its amendments from time to time.
24. At any given point of time there shall be only one denomination of the Equity Shares, unless otherwise permitted by law.
25. Our Company shall comply with such disclosure and accounting norms as may be specified by BSE, SEBI and other regulatory authorities from time to time.
26. There are no Equity Shares against which depository receipts have been issued.
27. Other than the Equity Shares, there is no other class of securities issued by our Company.
28. There are no safety net arrangements for this public issue.
29. As per RBI regulations, OCBs are not allowed to participate in this Issue.
30. Our Promoters and Promoter Group will not participate in this Issue.
31. This Issue is being made through Fixed Price Method.

SECTION V- PARTICULARS OF THE ISSUE

OBJECTS OF THE ISSUE

Issue of up to 15,00,000 Equity Shares of face value of ₹ 10 each for cash at price of ₹ [●] per Equity Share (including a premium of ₹ [●] per Equity Share), aggregating up to ₹ [●] Lakhs.

Issue Proceeds and Net Issue Proceeds

The details of the proceeds of the Issue are set forth in the table below:

(₹ in lakhs)

Particulars	Amount
Gross Proceeds of the Issue	[●]
Less: Issue related expenses ⁽¹⁾	[●]
Net Proceeds of the Issue	[●]

⁽¹⁾The Issue related expenses are estimated expenses and subject to change

Net Issue

Our Company proposes to utilize the Net Proceeds from Issue towards funding the following objects (collectively, referred to herein as the “Objects”):

1. Funding Working capital requirements;
2. General Corporate Purpose

The main objects and objects incidental and ancillary to the main objects set out in the Memorandum of Association enable us (i) to undertake our existing business activities and (ii) to undertake the activities proposed to be funded from the Net Proceeds.

Proposed Schedule of Implementation and Deployment of the Net Proceeds

The Net Proceeds of the Issue (“Net Proceeds”) are currently expected to be deployed in accordance with the schedule as stated below:

(₹ in lakhs)

Sr. No.	Particulars	Amount to be funded from the Net Proceeds	Amount to be deployed from the Net Proceeds in FY 2024-25	Amount to be deployed from the Net Proceeds in FY 2025-26
1.	Funding Working capital requirements	7,260.00	3,860.00	3,400.00
2.	General Corporate Purpose	[●]	[●]	[●]
Total		[●]	[●]	[●]

Requirements of Funds and Means of Finance

The fund requirements, the deployment of funds and the intended use of the Net Proceeds as described herein are based on our current business plan, management estimates, and other commercial and technical factors. We may have to revise our funding requirements and deployment on account of a variety of factors such as our financial and market condition, business and strategy, competition, variation in cost estimates on account of factors and other external factors including changes in the price of the equipment due to variation in commodity prices which may not be within the control of our management. This may entail rescheduling or revising the planned expenditure and funding requirements, including the expenditure for a particular purpose, subject to compliance with applicable law. For further details, see “Risk Factors – The Objects of the Issue for which funds are being raised have not been appraised by any bank or financial institution. The deployment of funds is entirely at the discretion of our management and as per the details mentioned in the section titled “Objects of the Issue”. Any revision in the estimates may require us to reschedule our expenditure and may have a bearing on our expected revenues and earnings”. To the extent our Company is unable to utilise any portion of the Net Proceeds towards the aforementioned objects of the Issue, as per the estimated schedule of deployment specified above, our Company shall deploy the Net Proceeds in the subsequent F.Ys towards the aforementioned objects.

The fund requirements for all objects are proposed to be entirely funded from the Net Proceeds. Accordingly, we confirm that there is no requirement for us to make firm arrangements of finance through verifiable means towards 75% of the stated means of finance.

In case of variations in the actual utilization of funds earmarked for the purposes set forth above, increased fund requirements for a particular purpose may be financed by our internal accruals and/ or debt, as required. If the actual utilization towards any of the objects is lower than the proposed deployment, such balance will be used for funding other objects as mentioned above or towards general corporate purposes to the extent that the total amount to be utilised towards general corporate purposes will not exceed 25% of the gross proceeds from the Issue in accordance with the SEBI ICDR Regulations.

DETAILS OF THE FUND REQUIREMENTS

1. Funding Working capital requirements

We are engaged in the manufacturing and servicing of shipboard machinery, critical component systems and test facilities for submarines & surface ships for The Indian Defence PSU Shipyard. Since our industry often involves complex manufacturing processes, any unforeseen disruptions—such as machinery breakdowns, supply chain issues, or sudden changes in customer demand—can significantly impact operations. As on December 31, 2024, we have order book of ₹ 55,160.19 lakhs. With the smooth flow of funds in our business and health financial position, we will be able to pursue a broader range of project tenders and therefore maximize our business volume and contract profit margins.

Our Company proposes to utilize ₹ 7,260.00 lakhs of the Net Proceeds for our working capital requirements. Net proceeds amounting to ₹ 3,860.00 amount will be utilized during Financial Year 2024-25 and balance amount during Financial Year 2025-26 towards our Company's working capital requirements. The balance portion of our Company working capital requirements shall be met from the debt facilities availed from banks and owned fund. The incremental and proposed working capital requirements, as approved by the Board pursuant to a resolution dated November 07, 2024 and key assumptions with respect to the determination of the same are mentioned below. Our Company's existing working capital requirements for F.Y 2021-22, F.Y 2022-23, F.Y 2023-24 and period ended September 30, 2024 and the proposed funding of such working capital requirements are as set out in the table below:

Basis of estimation of working capital requirements

(₹ in lakhs)

Particulars	F.Y 2021-22 (Restated)	F.Y 2022-23 (Restated)	F.Y 2023-24 (Restated)	September 30, 2024 (Restated)
Current Assets				
Inventories	2,083.36	3,727.78	5,268.18	5,796.14
Trade Receivables	1,314.39	813.31	882.30	5,210.00
Cash and bank balances	405.28	157.91	1727.32	416.83
Short Term Loans and Advances	829.46	834.88	3,287.66	2,177.71
Other Current Assets	122.16	657.04	993.94	994.47
Total Current Assets	4,754.64	6,190.93	12,159.40	14,595.16
Current Liabilities				
Trade Payables	1,961.07	933.91	243.62	1,099.14
Other Current Liabilities and Short-Term Provisions	482.44	835.13	916.11	1,448.81
Total Current Liabilities	2,443.51	1,769.04	1,159.73	2,547.95
Working Capital Gap	2,311.14	4,421.87	10,999.67	12,047.20
Funding Pattern				
Funding by Bank	402.87	1,463.22	1,490.51	1,231.43
Owned Funds	1,908.27	2,958.65	6,568.59*	10,815.77*

* Includes funding of ₹ 2,941.53 Lakhs from the net proceeds of the Initial Public Offer (IPO) via Prospectus dated May 23, 2023.

Our Company's expected working capital requirements for Financial Year 2024-25 and Financial Year 2025-26 and the proposed funding of such working capital requirements are as set out in the table below:

(₹ in lakhs)

Sr. No.	Particulars	F.Y 2024-25 (Projected)	F.Y 2025-26 (Projected)
I.	Current Assets:		
1	Inventories	7,250.00	9,000.00
2	Trade Receivables	4,000.00	6,500.00
3	Cash & Cash Equivalents	580.00	825.00
4	Short Term Loans and Advances	4,000.00	4,030.00
5	Other Current Assets	1,550.00	2,000.00
	Total Current Assets (A)	17,380.00	23,255.00
II.	Current Liabilities		
1	Trade Payables	300.00	400.00
2	Other Current Liabilities and Short-Term Provisions	500.00	800.00
	Total Current Liabilities (B)	800.00	1,200.00
III.	Total Working Capital Gap (A – B)	16,580.00	22,055.00
IV.	Funding Pattern:		
1.	Capital Account (Owned Fund)	11,220.00	13,295.00
2.	Funding from Bank*	1,500.00	1,500.00
3.	FPO	3,860.00	7,260.00

*Our sanctioned working capital facilities as on date of this Draft Prospectus comprised ₹ 1,500.00 lakhs from Axis Bank.

Our Statutory Auditor has, pursuant to a certificate dated November 07, 2024, certified the working capital requirements of our Company for the F.Y 2024-25 and F.Y 2025-26.

Holding Period level:

Sr. No.	Particulars	FY 2021-22	FY 2022-23	FY 2023-24	September 30, 2024	F.Y 2024-25 (Projected)	F.Y 2025-26 (Projected)
A.	Current Assets:						
1	Inventories	162	193	180	132	165	151
2	Trade receivables	102	42	30	118	91	90
B.	Current Liabilities						
1	Trade Payables	224	74	14	42	11	10

2. Justification for holding period levels

Particulars	Details
Current Assets	
Inventories	Inventories consist of raw materials only. In Financial Year 2021-22, 2022-23 and 2023-24, September 30, 2024 our inventory holding days were 162 days, 193 days and 180 days, 132 days respectively. Since we deal with specialized components or custom orders, we need to maintain a buffer of raw materials and semi-finished goods. Given the bespoke nature of our products and import of certain material, we may not always rely on just-in-time inventory systems, as delays in procuring specialized parts could halt production. Thus, a higher level of inventory requires more working capital. The Company estimates inventories holding period to be 165 and 151 days for F.Y 2024-25 and F.Y 2025-26.

	<p>Details of days for inventory holding period are as below:</p> <table border="1" data-bbox="451 253 1436 696"> <thead> <tr> <th>Particulars</th> <th>No of days- F.Y 2024-25</th> <th>No of days- F.Y 2025-26</th> </tr> </thead> <tbody> <tr> <td>Manufacturing & Assembling</td> <td>60-90 days</td> <td>60-78 days</td> </tr> <tr> <td>Quality Control & Inspection</td> <td>10-40 days</td> <td>10-35 days</td> </tr> <tr> <td>Rectification</td> <td>10-45 days</td> <td>10-40 days</td> </tr> <tr> <td>Integration & Testing</td> <td>10-35 days</td> <td>10-30 days</td> </tr> <tr> <td>Delivery & Deployment</td> <td>10-15 days</td> <td>10-15 days</td> </tr> <tr> <td>Maintenance & Lifecycle Support</td> <td>20-60 days</td> <td>20-55 days</td> </tr> <tr> <td>Additional days of holding inventory</td> <td>20-70 days</td> <td>20-60 days</td> </tr> <tr> <td>Estimated/ Projected Days</td> <td>165 days</td> <td>151 days</td> </tr> </tbody> </table> <p>Our Inventory levels being in the defense industry are influenced by distinct factors, largely attributed to the sector's inherent characteristics and operational demands such as:</p> <p><u>Long Product Development Cycles</u> Defense products like aircraft, submarines, and missiles have long lead times for development and production. High inventory levels of raw materials, components, and subassemblies ensure production continuity without delays.</p> <p><u>Unpredictable Demand</u> Defense contracts are often irregular, driven by government budgets and geopolitical situations. Maintaining high inventory levels ensures readiness to meet sudden demand or fulfill large contracts.</p> <p><u>Supply Chain Complexity</u> The defense industry depends on highly specialized suppliers, which may have long lead times or limited production capacity. Stockpiling critical components mitigates risks of supply chain disruptions.</p> <p><u>Strategic Stockpiling</u> For national security, certain items or raw materials (like rare earth metals) are stockpiled to ensure uninterrupted production during geopolitical tensions or trade restrictions</p> <p><u>Limited Economies of Scale</u> Unlike consumer industries, defense manufacturing doesn't benefit as much from mass production. Instead, components are produced or procured in bulk to achieve cost efficiency over time, leading to higher inventories.</p>	Particulars	No of days- F.Y 2024-25	No of days- F.Y 2025-26	Manufacturing & Assembling	60-90 days	60-78 days	Quality Control & Inspection	10-40 days	10-35 days	Rectification	10-45 days	10-40 days	Integration & Testing	10-35 days	10-30 days	Delivery & Deployment	10-15 days	10-15 days	Maintenance & Lifecycle Support	20-60 days	20-55 days	Additional days of holding inventory	20-70 days	20-60 days	Estimated/ Projected Days	165 days	151 days
Particulars	No of days- F.Y 2024-25	No of days- F.Y 2025-26																										
Manufacturing & Assembling	60-90 days	60-78 days																										
Quality Control & Inspection	10-40 days	10-35 days																										
Rectification	10-45 days	10-40 days																										
Integration & Testing	10-35 days	10-30 days																										
Delivery & Deployment	10-15 days	10-15 days																										
Maintenance & Lifecycle Support	20-60 days	20-55 days																										
Additional days of holding inventory	20-70 days	20-60 days																										
Estimated/ Projected Days	165 days	151 days																										
Trade Receivables	<p>In Financial Year 2021-22, 2022-23 and 2023-24, September 30, 2024 our trade receivables were 102 days, 42 days and 30 days and 118 days respectively. For growth in business, revenue and profit, we need to survive in competitive market. We often serve B2B markets, where customers, especially large organizations or government bodies, demand extended credit terms. This means the company may not receive payment for its products for 60-90 days or more, while still needing to pay its own suppliers and labour costs. Hence, working capital is necessary to bridge this cash flow gap. With the industry practice to provide a good credit period, our funds get deployed in the operating cycle. With the current trends in business, the holding level for debtor is expected to be 91 days and 90 days for F.Y 2024-25 and F.Y 2025-26.</p> <p>Details of trade receivable days are as below:</p> <table border="1" data-bbox="451 1951 1436 2038"> <thead> <tr> <th>Particulars</th> <th>No of days- F.Y 2024-25</th> <th>No of days- F.Y 2025-26</th> </tr> </thead> <tbody> <tr> <td>Invoice Submission & Acknowledgment</td> <td>7-10 days</td> <td>7-10 days</td> </tr> </tbody> </table>	Particulars	No of days- F.Y 2024-25	No of days- F.Y 2025-26	Invoice Submission & Acknowledgment	7-10 days	7-10 days																					
Particulars	No of days- F.Y 2024-25	No of days- F.Y 2025-26																										
Invoice Submission & Acknowledgment	7-10 days	7-10 days																										

	Document Verification	12-15 days	12-15 days
	Store Receipts	12-20days	12-20days
	Internal Approvals	20-25 days	20-25 days
	Payment Authorization	12-20 days	12-20 days
	Payment Processing	12-15 days	12-16 days
	Estimated/Projected Days	90 days	91 days
Short term loans & advances	The key items under this head are advance to suppliers, advances to employees and other advances. Based on restated financials for Financial Year 2021-22, 2022-23 and 2023-24, September 30, 2024, Short term loans and advances are 17.65%, 11.81%, 30.77% and 27.21% of revenue respectively. The production process of our suppliers is often complex and time-consuming due to the high level of customization and precision involved. As a result, the company needs to fund these production activities to avoid any disruption. For F.Y 2024-25 and F.Y 2025-26, 24.99% and 16.79% of Revenue respectively is projected for short term loans & advances		
Other current assets	Our other current assets include retention money and deposits, balances with revenue authorities and prepaid expenses. Based on restated financials for Financial Year 2021-22, 2022-23 and 2023-24, September 30, 2024 other current assets are 2.60% 9.30%, 9.30% and 12.43% of revenue respectively. Operating capital gets tied up in GST on sales, retention money with our customers due to the nature of business. For F.Y 2024-25 and F.Y 2025-26, 9.68% and 8.33% of Revenue respectively is projected for other current assets.		
Current Liabilities			
Trade Payables	In Financial 2021-22, 2022-23 and 2023-24 and September 30, 2024 our trades payable were 224 days, 74 days, 14 days and 42 days respectively. We often source raw materials and components that are specific and not widely available. Suppliers of such materials may demand upfront payment or offer shorter credit terms, adding to the pressure on working capital. Additionally, price fluctuations in specialized raw materials can impact the overall cost structure, requiring the company to maintain a larger buffer in its working capital to absorb these costs. Timely or early payment will also enable us to avail various trade discounts and better margins. Accordingly, we estimate that the Trade Payables be paid within a cycle of approximately 11 and 10 days for F.Y Year 2024-25 and F.Y 2025-26 respectively.		
Other current liabilities and Short-term provisions	Statutory tax dues payable, Expenses payables, advance from debtors & provision for tax, gratuity etc are included under this head. Based on restated financial for Financial Year 2021-22, 2022-23 and 2023-24, September 30, 2024 other current liabilities and Short-term provisions are 10.27%, 11.82%, 8.57% and 18.10% of Revenue respectively. For F.Y Year 2024-25 and F.Y 2025-26, 3.12% and 3.33% of Revenue is projected respectively for other current liabilities and Short-term provisions		

3. General Corporate Purpose

Our management will have flexibility to deploy ₹ [●] lakhs, aggregating to [●]% of the Gross Proceeds towards general corporate purposes, including but not restricted to strategic initiatives, partnerships, joint ventures and strategic entity/business acquisitions, branding, marketing, new client referral fees meeting exigencies which our Company may face in the ordinary course of business, to renovate and refurbish certain of our existing Company owned/leased and operated facilities or premises, towards brand promotion activities or any other purposes as may be approved by our Board, subject to compliance with the necessary provisions of the Companies Act.

Our management, in accordance with the policies of the Board, will have flexibility in utilizing any amounts for general corporate purposes under the overall guidance and policies of our Board. The quantum of utilization of funds towards any of the purposes will be determined by the Board, based on the amount actually available under this head and the business requirements of our Company, from time to time.

We confirm that any issue related expenses shall not be considered as a part of General Corporate Purpose. Further, we confirm that in terms of Regulation 230(2) of the SEBI ICDR Regulations, the extent of the Net Proceeds according to this Draft Prospectus, proposed to be used for general corporate purposes, shall not exceed 25% of the amount raised by our Company through the Issue of Equity Shares.

ISSUE RELATED EXPENSES

The total estimated Issue Expenses are ₹ [●], which is [●] % of the total Issue Size. The details of the Issue Expenses are tabulated below:

(₹ in lakhs)

Sr. No.	Particulars	Amount (₹ in lakhs) ⁽¹⁾	% of Total Expenses ⁽¹⁾	% of Total Issue size ⁽¹⁾
1	Issue Management fees including fees and payment to other intermediaries such as Legal Advisors, Registrars and other out of pocket expenses.	[●]	[●]%	[●]%
2	Brokerage and selling commission ⁽²⁾⁽³⁾⁽⁴⁾	[●]	[●]%	[●]%
3	Printing & Stationery, Distribution, Postage, etc.	[●]	[●]%	[●]%
4	Advertisement and Marketing Expenses	[●]	[●]%	[●]%
5	Stock Exchange Fees, Regulatory and other Expenses	[●]	[●]%	[●]%
Total		[●]	[●]%	[●]%

⁽¹⁾ Will be incorporated at the time of filing of the Prospectus and on determination of Issue Price and other details.

⁽²⁾ The SCSBs and other intermediaries will be entitled to a commission of ₹ [●]/- per every valid Application Form submitted to them and uploaded on the electronic system of the Stock Exchange by them.

⁽³⁾ The SCSBs would be entitled to processing fees of ₹ [●]/- per Application Form, for processing the Application Forms procured by other intermediaries and submitted to the SCSBs.

⁽⁴⁾ Further the SCSBs and other intermediaries will be entitled to selling commission of [●]% of the Amount Allotted (product of the number of Equity Shares Allotted and the Issue Price) for the forms directly procured by them and uploaded on the electronic system of the Stock Exchange by them.

The Issue expenses are estimated expenses and subject to change. The Issue expenses shall be payable within 30 working days post the date of receipt of the final invoice from the respective Intermediaries by our Company.

Appraisal and Bridge Loans

Our Company has not raised any bridge loans from any bank or financial institution as on the date of this Draft Prospectus, which are proposed to be repaid from the Net Proceeds.

Year wise Deployment of Funds / Schedule of Implementation

As on the date of this Draft Prospectus, no funds have been deployed on these objects. The entire Issue size is proposed to be deployed in the Financial Year 2024-25 and Financial Year 2025-26.

Monitoring of Utilization of Funds

Since the proceeds from the Issue do not exceed ₹10,000 lakhs, in terms of Regulation 262 of the SEBI ICDR regulations, our Company is not required to appoint a monitoring agency for the purposes of this Issue. Our Board and Audit Committee will monitor the utilisation of the proceeds of the Issue. Our Company will disclose the utilization of the Net Proceeds under a separate head in our balance sheet along with the relevant details, for all such amounts that have not been utilized. Our Company will indicate investments, if any, of unutilised Net Proceeds in the balance sheet of our Company for the relevant F.Y's subsequent to receipt of listing and trading approvals from the Stock Exchange.

Pursuant to the SEBI Listing Regulations, our Company shall disclose to the Audit Committee of the Board of Directors the uses and applications of the Net Proceeds. Our Company shall prepare a statement of funds utilised for purposes other than those stated in this Draft Prospectus and place it before the Audit Committee of the Board of Directors, as required under applicable law. Such disclosure shall be made only until such time that all the Net Proceeds have been utilised in full. The statement shall be certified by the statutory auditor of our Company. Furthermore, in accordance with the Regulation 32(1) of the SEBI Listing Regulations, our Company shall furnish to the Stock Exchange on a half yearly basis, a statement indicating (i) deviations, if any, in the utilisation of the proceeds of the Issue from the objects of the Issue as stated above; and (ii) details of category wise variations in the utilisation of the proceeds from the Issue from the objects of the Issue as stated above.

Interim Use of Funds

Pending utilization of the Net Proceeds for the purposes described above, our Company will deposit the Net Proceeds with scheduled commercial banks included in schedule II of the RBI Act. Our Company confirms that it shall not use the Net Proceeds for buying, trading or otherwise dealing in shares of any listed company or for any investment in the equity markets.

Variation in Objects

In accordance with Section 27 of the Companies Act, 2013, our Company shall not vary the objects of the Issue without our Company being authorised to do so by the Shareholders by way of a special resolution. In addition, the notice issued to the Shareholders in relation to the passing of such special resolution shall specify the prescribed details as required under the Companies Act. The notice in respect of such resolution to Shareholders shall simultaneously be published in the newspapers, one in English and one in Regional language of the jurisdiction where our Registered Office is situated. The Shareholders who do not agree to the above stated proposal, our Promoter or controlling Shareholders will be required to provide an exit opportunity to such dissenting Shareholders, at a price as may be prescribed by SEBI, in this regard.

Other Confirmations / Payment to Promoter and Promoter's Group from the IPO Proceeds

No part of the Net Proceeds will be paid by our Company as consideration to our Promoter, Promoter Group, our Board of Directors, our Key Management Personnel or Group Companies except in the normal course of business in compliance with applicable law.

BASIS OF ISSUE PRICE

The Issue Price shall be determined by our Company in consultation with the Lead Manager on the basis of the key business strengths. The face value of the Equity Shares is ₹ 10 and Issue Price is ₹ [.] per Equity Share and is [.] times the face value at the lower end of the Price Band and [.] times the face value at the higher end of the Price Band.. Investors should read the following basis with the sections titled “Risk Factors”, “Financial Information” and the chapter titled “Our Business” beginning on page nos 20, 140 and 89 respectively, of this Draft Prospectus to get a more informed view before making any investment decisions. The trading price of the Equity Shares of Our Company could decline due to these risk factors and you may lose all or part of your investments.

Qualitative Factors

Some of the qualitative factors and our strengths which form the basis for the Issue Price are:

1. Visible growth through Robust Order Book Position and Strong financial position
2. High entry barriers in defence manufacturing sector
3. Focus on Navy Defence Sector and strategic partnership with vendors for technological advancement
4. Experienced Promoters and Management Team

For more details on qualitative factors, refer to chapter “Our Business” on page no 89 of this Draft Prospectus.

Quantitative Factors

The information presented in this section is derived from our Restated Financial Statements. For more details on financial information, investors please refer the chapter titled “Financial Statements as Restated” on page no 140 of this Draft Prospectus.

Investors should evaluate our Company taking into consideration its earnings and based on its growth strategy. Some of the quantitative factors which may form the basis for computing the price are as follows:

1. Basic and Diluted Earnings / Loss Per Share (“EPS”)

Year ended March 31,	Basic & Diluted	
	EPS (in ₹)	Weights
2024	9.21	3
2023	7.10	2
2022	5.42	1
Weighted Average		7.88
September 30, 2024*		7.21

* Not Annualized

Notes:

- a. The face value of each Equity Share is Rs. 10 each.
- b. Basic EPS has been calculated as per the following formula:

$$\text{Basic EPS (₹)} = \frac{\text{Net profit/ (loss) as restated, attributable to Equity Shareholders}}{\text{Weighted average number of Equity Shares outstanding during the year/period}}$$

- c. Diluted EPS has been calculated as per the following formula:

$$\text{Diluted EPS (₹)} = \frac{\text{Net profit/ (loss) as restated, attributable to Equity Shareholders}}{\text{Diluted Weighted average number of Equity Shares outstanding during the year/period}}$$

- d. Basic and Diluted EPS calculations are in accordance with Accounting Standard 20 “Earnings per Share”, notified under section 133 of Companies Act, 2013 read together with paragraph 7 of Companies (Accounting) Rules, 2014.
- e. The above statement should be read in conjunction with Significant Accounting Policies and Notes to Restated Financial Statements as appearing in “Annexure IV & V - Financial Information” beginning on page no. 140 this Draft Prospectus.

2. Price Earnings Ratio (“P/E”) in relation to the Price of ₹ [●] per share of ₹ 10 each

Particulars	P/E at the Floor Price (no of times)	P/E at the Cap Price (no of times)
P/E ratio based on weighted average Basic and Diluted EPS as at March 31, 2024	[●]	[●]

Industry Peer Group P/E

Particulars	Industry P/E
Highest-	122.9
Lowest-	53.57
Industry Average	87.53

Notes

- The industry high and low has been considered from the industry peers set provided later in this chapter. The industry composite has been calculated as the arithmetic average P/E of the industry peers set disclosed in this section. For further details, see “Basis for Offer Price -Comparison of Accounting Ratios with Listed Industry Peers” on page 69;
- The industry P/E ratio mentioned above is based on the parameters for the Fiscal 2024.

3. Return on Net worth (RoNW)

Year ended March 31,	RoNW (%)	Weight
2024	13.57%	3
2023	40.56%	2
2022	52.06%	1
Weighted Average	28.98%	
September 30, 2024*	10.10%	

*Not Annualized

Note: Return on Net worth has been calculated as per the following formula:

$$\text{RoNW} = \frac{\text{Net profit/loss after tax, as restated}}{\text{Net worth excluding preference share capital and revaluation reserve}}$$

4. Net Asset Value (NAV) based on actual no. of equity shares at the end of the year

Particulars	NAV (₹)
NAV as at September 30, 2024	71.38
NAV as at March 31, 2024	64.67
NAV after Issue	
NAV at floor price	[●]
NAV at cap price	[●]
Issue Price (₹)	[●]

Note: Net Asset Value has been calculated as per the following formula:

$$\text{NAV} = \frac{\text{Net worth excluding preference share capital and revaluation reserve}}{\text{Outstanding number of Equity shares at the end of the year}}$$

5. Key Performance Indicators

All the KPIs disclosed below have been approved by a resolution of our Audit Committee dated November 07 2024 and the Audit Committee has confirmed that it has verified and audited details of all the KPIs pertaining to the Company that have been disclosed to earlier investors at any point of time during the period ended September 30, 2024 and last three years prior to the date of filing of this Draft Prospectus, if any. During the period ended September 30, 2024 and last three years prior to the date of filing of this Draft Prospectus, no allotment was made except for fresh issue through initial public offer and issuance of equity shares on bonus issue as disclosed in this

section and section entitled “*Capital Structure*” on page no 53 of this Draft Prospectus. Further, the KPIs herein have been certified by M/s. V.N. Purohit & Co., Statutory Auditor, by their certificate dated November 8, 2024 For further details, please refer to the sections entitled “*Our Business*” and “*Management’s Discussion and Analysis of Financial Condition and Results of Operations*” beginning on pages 89 and 159, respectively.

(Rs. in lakhs)

Particulars	For the period ended September 30, 2024*	Fiscal 2024	Fiscal 2023	Fiscal 2022
Revenue from Operations	8,003.41	10,685.91	7,066.63	4,698.77
EBITDA ⁽¹⁾	2,303.96	3,085.38	1,882.82	1,252.93
EBITDA Margin (%) ⁽²⁾	28.79%	28.87%	26.64%	26.67%
Restated profit for the period / year	1,404.61	1,708.78	1,013.60	773.32
Restated profit for the period / year Margin (%) ⁽³⁾	17.55%	15.99%	14.34%	16.46%
Return on Average Equity (“RoAE”) (%) ⁽⁴⁾	10.60%	22.64%	50.88%	70.65%
Return on Capital Employed (“RoCE”) (%) ⁽⁵⁾	13.33%	17.50%	24.18%	36.66%
Net Debt / EBITDA Ratio	0.69	0.20	2.35	1.00

*Not Annualised

Notes:

⁽¹⁾ EBITDA is calculated as restated profit for the period / year plus tax expense plus depreciation and amortization plus finance costs plus exceptional items.

⁽²⁾ EBITDA Margin is calculated as EBITDA divided by revenue from operations.

⁽³⁾ Restated profit for the period / year margin is calculated as restated profit for the period / year divided by revenue from operations.

⁽⁴⁾ RoAE is calculated as Net profit after tax divided by Average Equity.

⁽⁵⁾ RoCE is calculated as Earnings before interest and taxes (EBIT) divided by Capital Employed.

Our Company confirms that it shall continue to disclose all the KPIs included in this section on a periodic basis, at least once in a year (or any lesser period as determined by the Board of our Company), for a duration of one year after the date of listing of the Equity Shares on the Stock Exchange or till the complete utilisation of the proceeds of the Fresh Issue as per the disclosure made in the section “*Objects of the Offer*”, whichever is later or for such other duration as may be required under the SEBI ICDR Regulations as amended from time to time.

Comparison of Key Performance Indicators with listed Industry Peers

While the listed peers mentioned below operate in the same industry as us, and may have similar offerings or end use applications, our business may be different in terms of differing business models, different product verticals serviced or focus areas or different geographical presence. Below are details of the KPIs of our listed peers for and as at the Fiscal 2024:

(Amount ₹ in lakhs except percentages and ratios)

Particulars	CFF Fluid Control Limited	MTAR Technologies	Data Patterns (India) Limited	Bharat Electronics Limited	Paras Defence and Space Technologies Limited
Revenue from Operations	10,685.90	58,075.20	51,980.00	20,26,824.00	25,349.82
EBITDA ⁽¹⁾	3,085.38	11,850.90	26,765.00	5,71,655	5,926.95
EBITDA Margin (%) ⁽²⁾	28.87%	20.41%	51.49%	28.20%	23.38%
Restated profit for the period / year	1,708.78	5,611.30	18,169.00	3,98,524	3,003.79
Restated profit for the period / year Margin (%) ⁽³⁾	15.99%	9.66%	34.95%	19.66%	11.85%
Return on Average Equity (“RoAE”) (%) ⁽⁴⁾	22.64%	8.66%	14.59%	26.40%	7.00%

Particulars	CFF Fluid Control Limited	MTAR Technologies	Data Patterns (India) Limited	Bharat Electronics Limited	Paras Defence and Space Technologies Limited
Return on Capital Employed ("RoCE") (%) ⁽⁵⁾	17.50%	10.74%	18.96%	32.29%	8.67%
Net Debt / EBITDA Ratio	0.20	1.28	N.A	NA	1.04

Explanation for the Key Performance Indicators

Revenue from operations: Revenue from operations represents the total turnover of the business as well as provides information regarding the year over year growth of our Company.

EBITDA: EBITDA is calculated as Restated profit / loss for the period plus tax expense plus depreciation and amortization plus finance costs and any exceptional items. EBITDA provides information regarding the operational efficiency of the business of our Company.

EBITDA margin: EBITDA Margin the percentage of EBITDA divided by revenue from operations and is an indicator of the operational profitability of our business before interest, depreciation, ammortisation, and taxes.

Restated profit for the period / year: Restated profit for the period / year represents the profit / loss that our Company makes for the financial year or during the a given period. It provides information regarding the profitability of the business of our Company.

Restated profit for the period / year margin: Restated profit for the period / year Margin is the ratio of Restated profit for the period / year to the total revenue of the Company. It provides information regarding the profitability of the business of our Company as well as to compare against the historical performance of our business.

Return on Average Equity ("RoAE"): RoAE refers to Restated profit for the period / year divided by Average Equity for the period. Average Equity is calculated as average of the total equity at the beginning and ending of the period. RoAE is an indicator of our Company's efficiency as it measures our Company's profitability. RoAE is indicative of the profit generation by our Company against the equity contribution.

Return on Capital Employed ("RoCE"): RoCE is calculated as Earnings before interest and taxes (EBIT) divided by Capital Employed by the Company for the period. RoCE is an indicator of our Company's efficiency as it measures our Company's profitability. RoCE is indicative of the profit generation by our Company against the capital employed. However, for the peer group EBIT is calculated as Earnings before finance cost and taxes.

Net Debt/ EBITDA: Net Debt to EBITDA is a measurement of leverage, calculated as a company's interest-bearing liabilities minus cash or cash equivalents, divided by its EBITDA. It shows how many years it would take for a company to pay back its debt if net debt and EBITDA are held constant.

6. Past Transfer(s) / Allotment(s)

There has been no issuance of Equity Shares or convertible securities, (excluding the shares issued under issuance of bonus shares), during the 18 months preceding the date of this Draft Prospectus, where such issuance is equal to or more than 5% of the fully diluted paid-up share capital of the Company (calculated based on the pre-Offer capital before such transaction(s)), in a single transaction or multiple transactions.

There have been no secondary sales / acquisitions of Equity Shares or any convertible securities (where promoter / promoter group entities or shareholder(s) having the right to nominate director(s) in the Board of the Issuer Company are a party to the transaction) equivalent to or exceeding 5% of the fully diluted paid-up share capital of the Company(calculated based on the pre-Offer capital before such transaction(s)), whether in a single transaction or a group of transactions during the 18 months preceding the date of the this Draft Prospectus.

Further we had not undertaken any primary / new issuance of Equity Shares or any convertible securities during the period of preceding three years from the date of this Draft Prospectus except for issuance of equity shares

through Initial Public Offer on June 05, 2023 mentioned above and on bonus issue as disclosed in the section entitled “*Capital Structure*” on page no. 53 of this Draft Prospectus.

Weighted Average Cost of Acquisition (WACA) based on primary / secondary transactions (secondary transactions where by promoter / promoter group entities or shareholder(s) having the right to nominate director(s) in the Board of the Issuer Company are a party to the transaction) during the 3 years preceding the date of this Draft Prospectus (irrespective of the size of transactions) is given below:

Past Transactions	WACA	IPO Price [●]
WACA of Primary issuance*	165.00	[●] times
WACA of Secondary transactions	Nil	[●] times

*Excluding the shares issued under issuance of bonus shares

7. Comparison of Accounting Ratios with Listed Industry Peers:

Particulars	CMP	EPS (₹)	PE Ratio	RONW (%)	NAV per share (₹)	Face Value (₹)	Revenue from Operations (₹ in Lakhs)
		Basic /Diluted	Basic /Diluted				
CFF Fluid Control Limited							
March 31, 2024	701.10	9.21	76.12	13.57%	64.67	10.00	10,685.90
September 30, 2024	701.10	7.21	97.24	10.10%	71.38	10.00	8,003.41
Peer Group **							
Data Patterns (India) Limited	2,484.15	32.5	76.55	13.72%	236.53	2.00	51,980.00
MTAR Technologies Limited	1,771.35	18.24	97.11	8.30%	219.88	10.00	58,075.20
Bharat Electronics Limited	291.95	5.45	53.57	24.41%	22.34	1.00	20,26,824.00
Paras Defence and Space Technologies Limited	1,010.10	8.22	122.9	6.76%	114.00	10.00	25,349.82

**Source: www.bseindia.com.

Notes:

- The figures of CFF Fluid Control Limited are based on restated financial statements for the year ended March 31, 2024 and period ended September 30, 2024.
- Current Market Price (CMP) is the closing price of the CFF Fluid Control Limited and Peer group scripts as on January 03, 2025.
- The figures for the peer group are based on the Consolidated audited financials for the year ended March 31, 2024.

- The face value of our share is ₹10.00 per share and the Issue Price is of ₹[.] per share are [.] times of the face value.
- The Company in consultation with the Lead Manager believes that the Issue price of ₹ [.]per share for the Public Issue is justified in view of the above parameters. The investors may also want to peruse the Risk Factors and Financials of the Company including important profitability and return ratios, as set out in the Financial Statements included in this Draft Prospectus to have more informed view about the investment proposition. The Face Value of the Equity Shares is ₹ 10 per share and the Issue Price is [.] times of the face value i.e. ₹ [.] per share.

STATEMENT OF TAX BENEFITS

To,

The Board of Directors,

CFF Fluid Control Limited

Plot No 01, Survey No 96, Kumbhivli Madap
Khopoli IN, Khalapur Raigad
Raigarh MH 410203

Sub: Statement of Possible Special Tax Benefits available to CFF Fluid Control Limited (the “Company”) and its shareholders prepared in accordance with Securities and Exchange Board of India (Issue of Capital and Disclosure Requirements) Regulations, 2018 (“SEBI Regulations”) and the Companies Act, 2013, as amended (the “Act”).

This report is issued in accordance with the Engagement Letter dated November 8, 2024.

We M/s. V.N. Purohit & Co., Chartered Accountants hereby report that this certificate along with the annexure states the Statement of the possible special tax benefits available to the Company and shareholders of the Company under direct and indirect tax laws applicable for financial year 2024-25, relevant to the assessment year 2025-26 presently in force in India as on the date of this certificate, including the Income-tax Act, 1961 as amended by the Finance Act, 2023 applicable for the Financial Year 2024-25 relevant to the Assessment Year 2025-26, presently in force in India (the “Act”), the Central Goods and Services Tax Act, 2017, the Integrated Goods and Services Tax Act, 2017, Union Territory Goods and Services Tax Act, 2017, applicable goods and services tax legislations, as promulgated by various states in India (collectively, the “GST Acts”), Customs Act, 1962 (“Customs Act”) and the Customs Tariff Act, 1975 (“Tariff Act”), read with the rules, regulations, circulars and notifications issued in connection thereto, each as amended (collectively, the “Taxation Laws” and the Act, the GST Acts, Customs Act and Tariff Act, as defined above, are collectively referred to as the “Relevant Acts”). The Statement has been prepared by the management of the Company in connection with the proposed Public Issue, which we have initialed for identification purposes only.

These possible special tax benefits are dependent on the Company and/ or the Company’s shareholders fulfilling the conditions prescribed under relevant Direct Tax Laws, Indirect Tax Laws and other laws. Hence, the ability of the Company or the Company’s shareholders to derive these possible special tax benefits is dependent upon their fulfilling such conditions, which is based on business imperatives the Company may face in the future and accordingly, the Company or the Company’s shareholders may or may not choose to fulfil. The Company does not have any subsidiary as on date of the Draft Prospectus/ Prospectus.

The benefits discussed in the enclosed Statement are not exhaustive and only cover the possible special direct and indirect tax benefits available to the Company and the Company’s shareholders. The Statement is neither designed nor intended to be a substitute for professional tax advice and each investor is advised to consult his or her own tax consultant with respect to the specific tax implications arising out of their participation in the proposed initial public offering of equity shares of the Company.

We conducted our examination in accordance with the “Guidance Note on Reports or Certificates for Special Purposes (Revised 2016)” (“**Guidance Note**”) issued by the Institute of Chartered Accountants of India. The Guidance Note requires that we comply with ethical requirements of the Code of Ethics issued by the Institute of Chartered Accountants of India. We have also complied with the relevant applicable requirements of the Standard on Quality Control (SQC) 1, Quality Control for Firms that Perform Audits and Reviews of Historical Financial information, and Other Assurance and Related Services Engagements.

We do not express any opinion or provide any assurance as to whether:

- a) the Company or its shareholders will continue to obtain these possible special tax benefits in future; or
- b) the conditions prescribed for availing the possible special tax benefits, where applicable, have been/would be met with; and

The contents of this Statement are based on the information, explanations and representations obtained from the Company and on the basis of our understanding of the business activities and operations of the Company. No assurance is given that the revenue authorities/ courts will concur with the views expressed herein. Our views are based on the existing provisions of law and its interpretation, which are subject to change from time to time. We do not assume responsibility to update the views consequent to such changes.

This certificate is issued for the sole purpose of the Issue, and can be used, in full or part, for inclusion in the Issue documents, and for the submission of this certificate as may be necessary, to any regulatory / statutory authority, stock exchanges, any other authority as may be required and/or for the records to be maintained by the Lead Manager in connection with the Issue and in accordance with applicable law.

We undertake to update you of any change in the above-mentioned disclosures until the Equity Shares allotted, pursuant to the Offer, are listed and commence trading on the Stock Exchange. In the absence of any such communication from us, the above information should be considered as updated information until the Equity Shares commence trading on the Stock Exchange, pursuant to the Offer. We hereby give consent to include this Statement in the Draft Prospectus in connection with the proposed further public offering of the Company.

Further, we give no assurance and assume no responsibility that the revenue authorities/ courts will concur with our views expressed herein. Our views are based on the existing provisions of law and its interpretation, which are subject to change from time to time. We shall not be liable to the Company for any claims, liabilities or expenses relating to this assignment except to the extent of fees relating to this assignment, as finally judicially determined to have resulted primarily from bad faith or intentional misconduct. We will not be liable to the Company and any other person (excluding the LMs, their affiliates and the legal counsels to the Company and the LMs) in respect of this Statement, except as per applicable law.

All capitalized terms used herein and not specifically defined shall have the same meaning as ascribed to them in the Issue Documents.

Yours sincerely,

For M/s. V.N. Purohit & Co.
Chartered Accountants
FRN: 304040E

O.P. Pareek
Partner
Membership No: 014238
Place: New Delhi
Date: November 08, 2024
UDIN: 24014238BKAUIY4351

Annexure A

STATEMENT OF POSSIBLE SPECIAL TAX BENEFITS AVAILABLE TO THE COMPANY AND COMPANY'S SHAREHOLDERS.

Outlined below are the possible special tax benefits available to **CFF Fluid Control Limited ("the Company")** and to its Shareholders under the Direct and Indirect Tax Laws in force in India.

A. SPECIAL TAX BENEFITS AVAILABLE TO THE COMPANY

1. Direct Tax

There are no special direct tax benefits available to the Company.

2. Indirect Tax

There are no special indirect tax benefits available to the Company.

B. SPECIAL TAX BENEFITS AVAILABLE TO THE SHAREHOLDERS OF THE COMPANY

1. Direct Tax

There are no special direct tax benefits available to the Shareholders of the Company.

2. Indirect Tax

There are no special indirect tax benefits available to the Shareholders of the Company.

SECTION VI – ABOUT OUR COMPANY

INDUSTRY OVERVIEW

The information in this section includes extracts from publicly available information, data and statistics and has been derived from various government publications, publically available documents and industry sources. Neither we nor any other person connected with the Issue have verified this information. The data may have been re-classified by us for the purposes of presentation. Industry sources and publications generally state that the information contained therein has been obtained from sources generally believed to be reliable, but that their accuracy, completeness and underlying assumptions are not guaranteed and their reliability cannot be assured and, accordingly, investment decisions should not be based on such information. You should read the entire Prospectus, including the information contained in the sections titled “Risk Factors” and “Financial Statements” and related notes beginning on page nos. 20 and 140 of this Draft Prospectus.

GLOBAL ECONOMIC OVERVIEW

Latest projections are for the global economy to continue growing at a similar pace as in 2023 during 2024–25 and for global headline and core inflation to decline steadily. There is little change in the forecast for global growth since the January 2024 WEO Update, with some adjustments for major economies, including a further strengthening in the projection for the United States, offset by modest downward revisions across several other economies. The forecast for global growth remains higher, however, than in the October 2023 WEO. The outlook for inflation is broadly similar to that in the October 2023 WEO, with a downward revision for advanced economies, offset by an upward revision for emerging market and developing economies. Medium-term prospects for growth in world output and trade remain the lowest in decades, with the pace of convergence toward higher living standards slowing for middle- and lower-income countries. The baseline forecasts for the global economy are predicated on a number of projections for global commodity prices, interest rates, and fiscal policies.

Global growth, estimated at 3.2 percent in 2023, is projected to continue at the same pace in 2024 and 2025. Nevertheless, the projection for global growth in 2024 and 2025 is below the historical (2000–19) annual average of 3.8 percent, reflecting restrictive monetary policies and withdrawal of fiscal support, as well as low underlying productivity growth. Advanced economies are expected to see growth rise slightly, with the increase mainly reflecting a recovery in the euro area from low growth in 2023, whereas emerging market and developing economies are expected to experience stable growth through 2024 and 2025, with regional differences.

Economic activity was surprisingly resilient during the global disinflation of 2022–23. Growth in employment and incomes has held steady as favorable demand and supply developments have supported major economies, despite rising central bank interest rates aimed at restoring price stability. As inflation converges toward target levels and central banks pivot toward policy easing, a tightening of fiscal policies aimed at curbing high government debt levels, with higher taxes and lower government spending, is expected to weigh on growth. The pace of expansion is also expected to remain low by historical standards as a result of factors including the long-term consequences of the COVID-19 pandemic, Russia’s invasion of Ukraine, weak growth in productivity, and increasing geoeconomic fragmentation.

In late 2023, headline inflation neared its prepandemic level in most economies for the first time since the start of the global inflation surge. In the last quarter of 2023, headline inflation for advanced economies was 2.3 percent on a quarter-over-quarter annualized basis, down from a peak of 9.5 percent in the second quarter of 2022. For emerging market and developing economies, inflation was 9.9 percent in the last quarter of 2023, down from a peak of 13.7 percent in the first quarter of 2022, but this average was driven by high inflation in a few countries; for the median emerging market and developing economy, inflation declined to 3.9 percent. This progress notwithstanding, inflation is not yet at target in most economies.

Global Inflation Falling as Output Grows

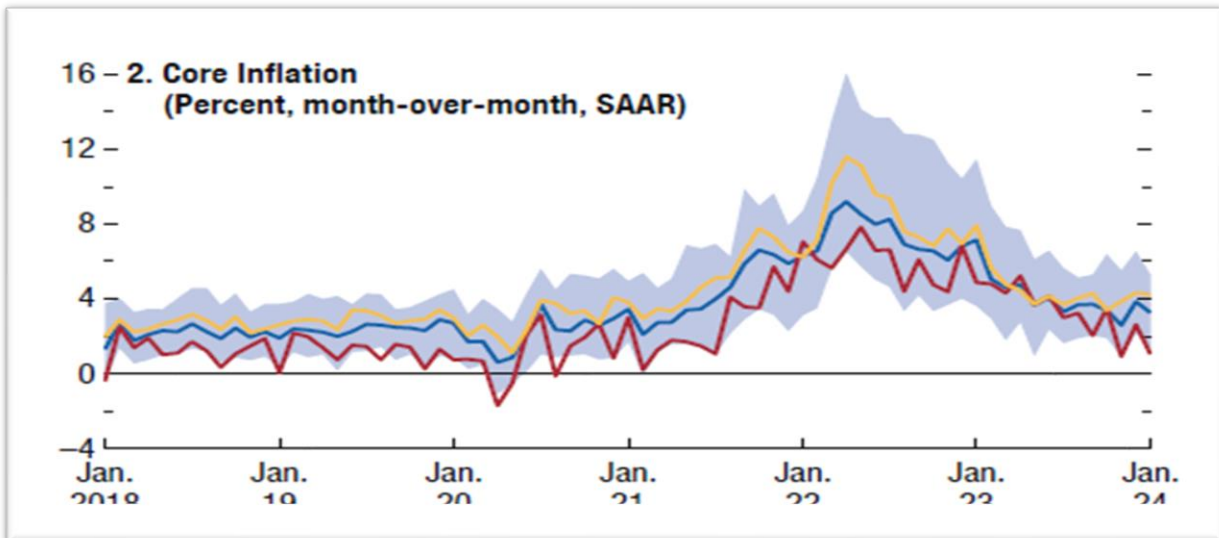
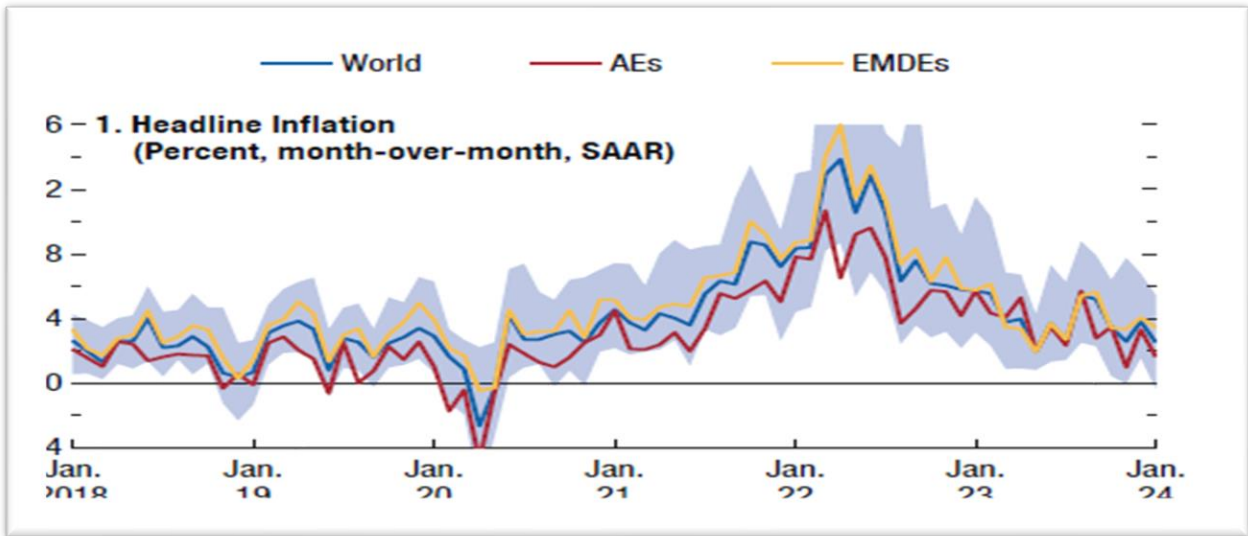

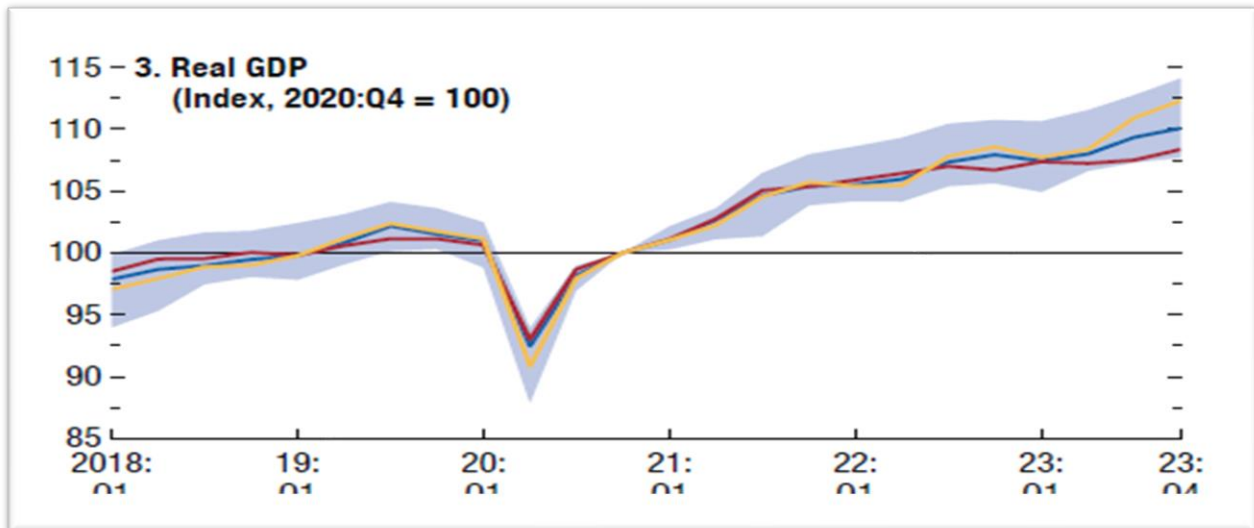

To counter rising inflation, major central banks have raised policy interest rates to levels estimated as restrictive. As a result, mortgage costs have increased and credit availability is generally tight, resulting in difficulties for firms refinancing their debt, rising corporate bankruptcies, and subdued business and residential investment in several economies. The commercial real estate sector, including office markets, is under especially strong pressure in some economies, with rising defaults and lower investment and valuations, reflecting the combined effects of higher borrowing costs and the shift toward remote work since the pandemic.

However, despite concerns, a global economic downturn caused by a sharp rise in policy rates has not materialized, for several reasons. First, some central banks—including the European Central Bank and the Federal Reserve—raised their nominal interest rates after inflation expectations started to rise, resulting in lower real rates that initially supported economic activity. The Bank of Japan has continued to keep policy rates near zero, resulting in a steady decline in real interest rates. By contrast, the central banks of Brazil, Chile, and several other emerging market and developing economies raised rates relatively quickly, resulting in earlier increases in real interest rates. Second, households in major advanced economies were able to draw on substantial savings accumulated during the pandemic to limit the impact of higher borrowing costs on their spending. Third, changes in mortgage and housing markets over the prepandemic decade of low interest rates have limited the drag of the recent rise in policy rates on household consumption in several economies.

World Economic Outlook Growth Projections

(Real GDP, annual percent change)	PROJECTIONS		
	2023	2024	2025
World Output	3.2	3.2	3.2
Advanced Economies	1.6	1.7	1.8
United States	2.5	2.7	1.9
Euro Area	0.4	0.8	1.5
Germany	-0.3	0.2	1.3
France	0.9	0.7	1.4
Italy	0.9	0.7	0.7
Spain	2.5	1.9	2.1
Japan	1.9	0.9	1.0
United Kingdom	0.1	0.5	1.5
Canada	1.1	1.2	2.3
Other Advanced Economies	1.8	2.0	2.4
Emerging Market and Developing Economies	4.3	4.2	4.2
Emerging and Developing Asia	5.6	5.2	4.9
China	5.2	4.6	4.1
India	7.8	6.8	6.5
Emerging and Developing Europe	3.2	3.1	2.8
Russia	3.6	3.2	1.8
Latin America and the Caribbean	2.3	2.0	2.5
Brazil	2.9	2.2	2.1
Mexico	3.2	2.4	1.4
Middle East and Central Asia	2.0	2.8	4.2
Saudi Arabia	-0.8	2.6	6.0
Sub-Saharan Africa	3.4	3.8	4.0
Nigeria	2.9	3.3	3.0
South Africa	0.6	0.9	1.2
Memorandum			
Emerging Market and Middle-Income Economies	4.4	4.1	4.1
Low-Income Developing Countries	4.0	4.7	5.2

Source: IMF, *World Economic Outlook*, April 2024

Note: For India, data and forecasts are presented on a fiscal year basis, with FY 2023/24 (starting in April 2023) shown in the 2023 column. India's growth projections are 6.9 percent in 2024 and 6.5 percent in 2025 based on calendar year.

INTERNATIONAL MONETARY FUND

IMF.org

(Source : <https://www.imf.org/en/Publications/WEO/Issues/2024/04/16/world-economic-outlook-april-2024>)

INDIAN ECONOMY OVERVIEW

Strong economic growth in the first quarter of FY23 helped India overcome the UK to become the fifth-largest economy after it recovered from the COVID-19 pandemic shock. Nominal GDP or GDP at Current Prices in the year 2023-24 is estimated at Rs. 295.36 lakh crores (US\$ 3.54 trillion), against the First Revised Estimates (FRE) of GDP for the year 2022-23 of Rs. 269.50 lakh crores (US\$ 3.23 trillion). The growth in nominal GDP during 2023-24 is estimated at 9.6% as compared to 14.2% in 2022-23. Strong domestic demand for consumption and investment, along with Government's continued emphasis on capital expenditure are seen as among the key driver of the GDP in the second half of FY24. During the period April-June 2025, India's exports stood at US\$ 109.11 billion, with Engineering Goods (25.35%), Petroleum Products (18.33%) and electronic goods (7.73%) being the top three exported commodity. Rising employment and increasing private consumption, supported by rising consumer sentiment, will support GDP growth in the coming months.

Future capital spending of the government in the economy is expected to be supported by factors such as tax buoyancy, the streamlined tax system with low rates, a thorough assessment and rationalisation of the tariff structure, and the

digitization of tax filing. In the medium run, increased capital spending on infrastructure and asset-building projects is set to increase growth multipliers. The contact-based services sector has demonstrated promise to boost growth by unleashing the pent-up demand. The sector's success is being captured by a number of HFIs (High-Frequency Indicators) that are performing well, indicating the beginnings of a comeback.

India has emerged as the fastest-growing major economy in the world and is expected to be one of the top three economic powers in the world over the next 10-15 years, backed by its robust democracy and strong partnerships. India's appeal as a destination for investments has grown stronger and more sustainable because of the current period of global unpredictability and volatility, and the record amounts of money raised by India-focused funds in 2022 are evidence of investor faith in the "Invest in India" narrative.

Market Size

Real GDP or GDP at Constant (2011-12) Prices in the year 2023-24 is estimated at Rs. 173.82 lakh crores (US\$ 2.08 trillion), against the First Revised Estimates (FRE) of GDP for the year 2022-23 of Rs. 160.71 lakh crores (US\$ 1.92 trillion). The growth in real GDP during 2023-24 is estimated at 8.2% as compared to 7.0% in 2022-23. The government is also focusing on renewable sources by achieving 40% of its energy from non-fossil sources by 2030. India is committed to achieving the country's ambition of Net Zero Emissions by 2070 through a five-pronged strategy, 'Panchamrit'. Moreover, India ranked 3rd in the renewable energy country attractive index.

According to the McKinsey Global Institute, India needs to boost its rate of employment growth and create 90 million non-farm jobs between 2023 to 2030 in order to increase productivity and economic growth. The CAD stood at US\$ 23.2 billion for the 2023-24 compared to US\$ 67.0 billion or 2.0% of GDP in the preceding year. This was largely due to decrease in merchandise trade deficit.

Recent Developments

- As of July 5, 2024, India's foreign exchange reserves stood at US\$ 657.15 billion..
- In May 2024, India saw a total of US\$ 6.9 billion in PE-VC investments.
- Merchandise exports in June 2024 stood at US\$ 35.20 billion, with total merchandise exports of US\$ 109.96 billion during the period of April 2024 to June 2024.
- In June 2024, the gross Goods and Services Tax (GST) stood at highest monthly revenue collection at Rs. 1.74 lakh crore (US\$ 20.83 billion) vs Rs. 1.73 lakh crore (US\$ 20.71 billion)
- In May 2024, the overall IIP (Index of Industrial Production) stood at 154.2. The Indices of Industrial Production for the mining, manufacturing and electricity sectors stood at 136.5, 149.7 and 229.3, respectively, in May 2024.
- Between April 2000–March 2024, cumulative FDI equity inflows to India stood at US\$ 97 billion.
- Foreign Institutional Investors (FII) inflows between April-July (2023-24) were close to Rs. 80,500 crore (US\$ 9.67 billion), while Domestic Institutional Investors (DII) sold Rs. 4,500 crore (US\$ 540.56 million) in the same period. As per depository data, Foreign Portfolio Investors (FPIs) invested (US\$ 13.89 billion) in India during January- (up to 15th July) 2024.
- According to data released by the Ministry of Statistics & Programme Implementation (MoSPI), India's Consumer Price Index (CPI) based retail inflation reached 5.08% (Provisional) for June 2024.

Road Ahead

In the second quarter of FY24, the growth momentum of the first quarter was sustained, and high-frequency indicators (HFIs) performed well in July and August of 2023. India's comparatively strong position in the external sector reflects the country's positive outlook for economic growth and rising employment rates. India ranked 5th in foreign direct investment inflows among the developed and developing nations listed for the first quarter of 2022.

India's economic story during the first half of the current financial year highlighted the unwavering support the government gave to its capital expenditure, which, in 2023-24, stood 37.4% higher than the same period last year. In the budget of 2023-24, capital expenditure took lead by steeply increasing the capital expenditure outlay by 37.4 % in BE 2023-24 to Rs.10 lakh crore (US\$ 120.12 billion) over Rs. 7.28 lakh crore (US\$ 87.45 billion) in RE 2022-23. The ratio of revenue expenditure to capital outlay increased by 1.2% in the current year, signalling a clear change in favour of higher-quality spending. Stronger revenue generation because of improved tax compliance, increased profitability of the company, and increasing economic activity also contributed to rising capital spending levels. In February 2024, the Finance Ministry announced the total expenditure in Interim 2024-25 estimated at Rs. 47,65,768 crore (US\$ 571.64 billion) of which total capital expenditure is Rs. 11,11,111 crore (US\$ 133.27 billion).

(Source: <https://www.ibef.org/economy/indian-economy-overview>)

GLOBAL MARITIME INDUSTRY OVERVIEW

The global marine vessel market size was valued at USD 152.38 billion in 2023. The market is projected to grow from USD 160.56 billion in 2024 to USD 247.96 billion by 2032, exhibiting a CAGR of 5.6% during the forecast period. Asia Pacific dominated the marine vessel market with a market share of 52.46% in 2023.

Marine Vessel Market Trends

- *Modern Digital Transformation and Technologies that are Used in Shipbuilding to Enable Market Growth*

The use of modern technologies is being actively applied in the shipbuilding sector, which is developing at a rapid pace. Digital transformation is at the forefront of competition and globalization. This trend requires the shipbuilding industry to find a road map that will enable it to adapt to the digital age. The increasing use of modern technologies in shipbuilding is escalating the market growth. Technologies, such as 3D printing, engines powered by LNG, cybersecurity, digital platforms, fuel optimization systems, smart ship solutions, laser cladding machines, Internet of Things, new material, robotics, virtual and augmented reality, and others are propelling the demand for shipbuilders.

- *International Maritime Trade has Continued to Grow to Propel the Market Growth*

The backbone of globalization and industrialization is sea transport, which promotes supply chains facilitating trade across borders. The increasing focus of major suppliers in various markets relying on sea routes for transport is driving the market. Higher focus from raw material suppliers and commodity market suppliers to transport cargo through marine shipments is estimated to drive market growth as it reduces fairly low carbon emissions compared to road freight transportation. Due to increased demand for large volumes of products, particularly crude oil, steel, ore, and finished goods, such as motor vehicles, predominantly from developing countries, shipping has experienced strong growth over the last decade. The trans-shipment of goods by sea or other waterways and their transit through the world's seaports account for about the largest trade volume.

The rise in trade volume is increasing the demand for ships. Further, as per the UNCTAD report, 11,055 million tons of goods were transported in 2019 and 10,631 million tons in 2020. Moreover, the demand for tankers, cargo ships, commercial bulk carriers, and special purpose vessels will increase due to an upward trend in international seaborne trade or maritime transportation, reinforcing the shipbuilding sector's outlook.

- *Increase in Trade-related Agreements Aids the Market Growth*

Numerous trade agreements have been concluded as regards the transportation of goods by both developed and developing countries. Suppliers have, therefore, shifted the choice of waterways as a more efficient mode of transport. This increased tendency has led to better and more efficient container carriers with different sizes and capacities being developed by the cargo vessel operators, thus driving the marine vessel market growth. Furthermore, FTAs made reductions in customs duties and taxes possible. The post-pandemic recovery resulted in a rapid acceleration in freight and cargo transportation movement in all sectors, leading to higher demand for marine vessels. Thus, an increase in cargo movements through seaways also witnessed a significant change, resulting in market growth.

(Source: <https://www.fortunebusinessinsights.com/marine-vessel-market-102699>)

Global Marine Valves and Actuators Market Outlook

The Marine Actuators and Valves Market size is expected to reach USD 3.6 Billion by 2027 from USD 2.8 Billion in 2022, at a Compound Annual Growth Rate (CAGR) of 5.3% from 2022 to 2027. The key factor driving the growth of the worldwide Marine Actuators and Valves Industry is the increase in global commercial trade and the spike in demand for high precision motion control devices on board marine vessels. Additionally, the growing commercial and defence fleets of nations worldwide is driving the market for marine actuators and valves than can meet the requirements of sustainable marine transportation.

Market growth in the Asia Pacific can be attributed to presence of a large and growing shipbuilding industry, and increasing need for systems fluid control systems on board marine vessels, the emergence of big data, and increasing spending on Naval fleet expansion.

Attractive opportunities in this industry are as below:

 <p>Rising seaborne trade levels, maritime tourism, fleet expansion and modernization drives are key factors driving the market growth.</p>	 <p>Utilization of analytics, artificial intelligence, 3D simulation and big data to increase R&D productivity are factors expected to provide lucrative opportunities for market players.</p>
 <p>The European Marine Actuators and Valves market is expected to be worth USD 1.1 billion by 2027, growing at CAGR of 5.5% during the forecast period.</p>	 <p>Issues associated with valve safety owing to leakage, corrosion and harsh operational environment are expected to pose a challenge to the growth of this market.</p>

(Source: <https://www.marketsandmarkets.com/Market-Reports/marine-actuator-valve-market>)

INDIAN SHIPPING INDUSTRY OVERVIEW

According to the Ministry of Shipping, around 95% of India's trading by volume and 70% by value is done through maritime transport. In November 2020, the Prime Minister, Mr. Narendra Modi renamed the Ministry of Shipping as the Ministry of Ports, Shipping and Waterways.

India has 12 major and 200+ notified minor and intermediate ports. Under the National Perspective Plan for Sagarmala, six new mega ports will be developed in the country. The Indian ports and shipping industry play a vital role in sustaining growth in the country's trade and commerce. India is the sixteenth-largest maritime country in the world with a coastline of 7,516.6 kms. The Indian Government plays an important role in supporting the ports sector. It has allowed Foreign Direct Investment (FDI) of up to 100% under the automatic route for port and harbour construction and maintenance projects. It has also facilitated a 10-year tax holiday to enterprises that develop, maintain, and operate ports, inland waterways, and inland ports.

Market Size

In FY24, all key ports in India handled 817.97 million tonnes (MT) of cargo traffic, a 4.45% increase from 784.305 million tonnes in FY23. India's merchandise exports in FY23 were at US\$ 451 billion from US\$ 417 billion in the previous year. The Government has taken several measures to improve operational efficiency through mechanisation, deepening the draft and speedy evacuations.

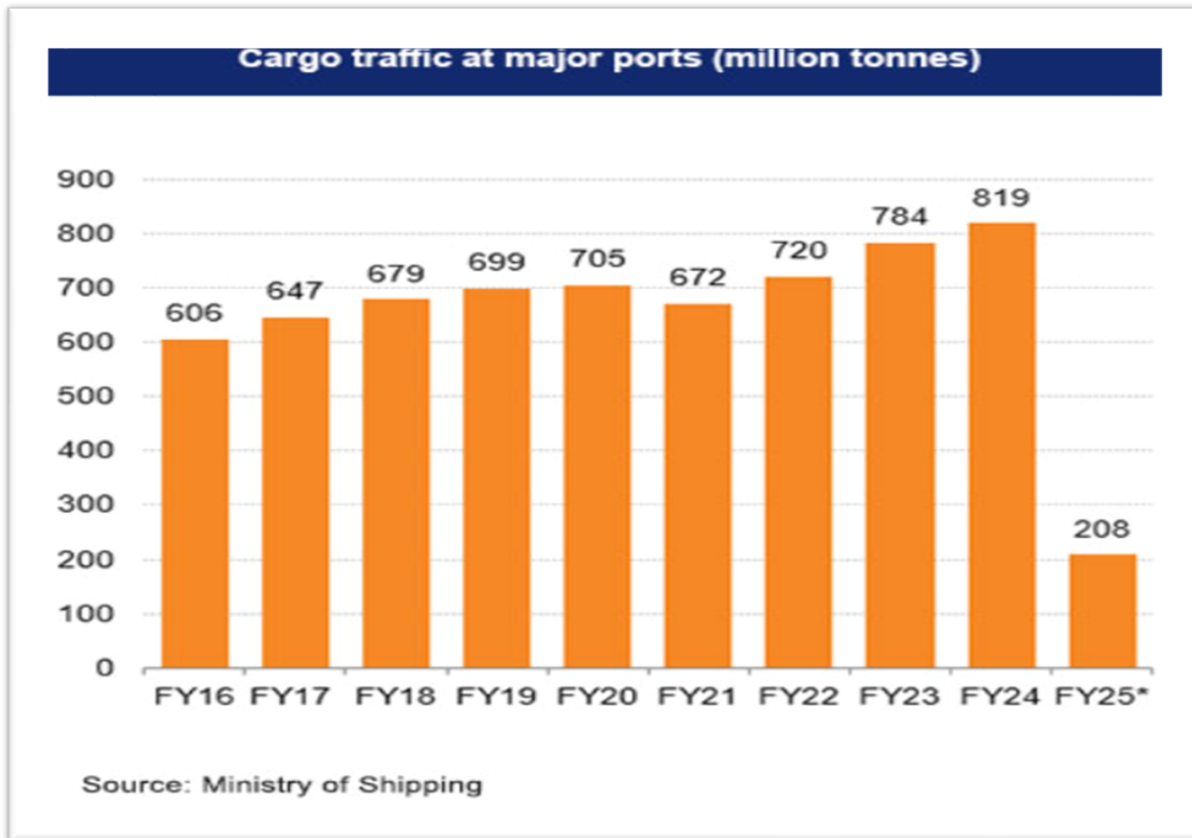

(Source: <https://www.ibef.org/industry/ports-india-shipping>)

GLOBAL DEFENCE MARKET OUTLOOK

The global defence market size is expected to grow from \$575.33 billion in 2023 to \$616.32 billion in 2024 at a compound annual growth rate (CAGR) of 7.1%. The defence market is expected to reach \$772.49 billion in 2028 at a CAGR of 5.8%.

The defence market consists of sales of air-based, sea-based and land-based military equipment by entities (organizations, sole traders and partnerships) that produce air-based, sea-based and land-based military equipment including support and auxiliary equipment such as radar, satellites, sonars, and other auxiliary equipment or maintain, repair and overhaul defence equipment.

The main defence types are air-based defence equipment, sea-based defence equipment, land-based defence equipment, defence equipment maintenance, repair and overhaul services, defence support, and auxiliary equipment. Air-based defence equipment includes support and auxiliary equipment for the air-based defence such as radar, satellites, sonars, and other auxiliary equipment. The various operation includes autonomous defence equipment, manual and involves various platforms such as airborne, land and naval.

(Source: <https://www.thebusinessresearchcompany.com/report/defence-global-market-report>)

INDIAN DEFENCE MARKET OUTLOOK

India is one of the strongest military forces in the world and holds a place of strategic importance for the Indian government. The top three largest market segments of the Indian defence sector are military fixed wing, naval vessels and surface combatants, and missiles and missile defence systems. Military rotorcraft, submarines, artillery, tactical communications, electronic warfare, and military land vehicles are some of the other well-known segments. Some of the major defence manufacturing companies in India are Bharat Earth Movers Ltd. (BEML), Bharat Electronics Ltd. (BEL), and Hindustan Aeronautics Ltd. (HAL).

The Indian defence manufacturing industry is a significant sector for the economy. The industry is likely to accelerate with rising concerns of national security. Demand for defence equipment in India has been growing due to the ongoing

territorial disputes with Pakistan and China over the ownership of the Northern State of Kashmir and the North Eastern State of Arunachal Pradesh, respectively. Over the last five years, India has been ranked among the top importers of defence equipment to gain technological advantages over rival countries such as China and Pakistan. To modernise its armed forces and reduce dependency over external dependence for defence procurement, several initiatives have been taken by the government to encourage ‘Make in India’ activities via policy support initiatives.

Key Points-

- India’s defence budget of US\$ 74.7 billion ranked fourth highest globally in 2024.
- India has the world’s fourth largest defence expenditure, as of 2022, and has set a target of US\$ 6.02 billion (Rs. 50,000 crore) worth of annual defence exports by 2028-29.
- In the Interim Budget 2024-25, US\$ 2.9 billion (Rs. 23,855 crore) was allocated to DRDO, while a corpus of US\$ 12.0 billion (Rs. 1 lakh crore) was earmarked for Deep Tech, offering long-term loans to tech-savvy companies to foster innovation in defence technologies within India.
- In the Regular Union Budget of FY25, Ministry of Defence (MoD) has been allocated Rs. 6,21,940.85 crore (approx. US\$ 75 Billion), the highest among the Ministries.
- As per the Union Budget 2022-23, 25% of the defence R&D budget has been earmarked for private industry and start-ups which will pave the way for the innovation of new defence technologies in India.
- Till April 2023, a total of 606 industrial licences were issued to 369 companies operating in the defence sector. Defence exports rose 240% over five years in FY23, to US\$ 1.9 billion (Rs. 15,918.16 crore). India now exports to over 85 countries due to collaborative efforts.
- Defence exports stood at Rs. 21,083 crores (US\$ 2.54 billion) in 2023-24 which is 31% increase from previous year.
- Till October 2022, a total of 595 Industrial Licences have been issued to 366 companies operating in Defence Sector. Defence exports grew by 334% in the last five years; India now exports to over 75 countries due to collaborative efforts.



(Source : <https://www.ibef.org/industry/defence-manufacturing>)

Market Size

According to the Global Power Index, the Indian defence sector ranks fourth in terms of firepower with a score of 0.0979 (with 0.0 being the perfect score). The Indian government has set the defence production target at US\$ 25 billion by 2025 (including US\$ 5 billion from exports by 2025). India is one of the world’s biggest defence spenders with a total outlay of US\$ 74.8 billion (Rs. 6.21 lakh crore), accounting for 13.04% of the total budget and indicating an increase of 4.72% over the Budget of 2023-24 and 18.35% over the allocation for 2022-23.

India's military spending of US\$ 81.4 billion ranked fourth highest in the world in 2022. This was up by 6% from 2021.

The value of defence production in the country for 2023-24 stood at Rs. 1,26,887 crore (US\$ 15.3 billion) while the defence production by PSU's stood at Rs. 73,945 crore (US\$ 8.93 billion).

India's defence import value stood at US\$ 463 million for FY20 and US\$ 469.5 million in FY21. India targets to export military hardware worth US\$ 5 billion (Rs. 35,000 crore) in the next five years. As of 2019, India ranked 19th in the list of top defence exporters in the world by exporting defence products to 42 countries. Defence exports stood at US\$ 2.53 billion (Rs. 21,083 crores) in 2023-24 which is 32% increase from previous year. Defence exports rose 240% over five years in FY23 and India now exports to over 85 countries due to collaborative efforts.

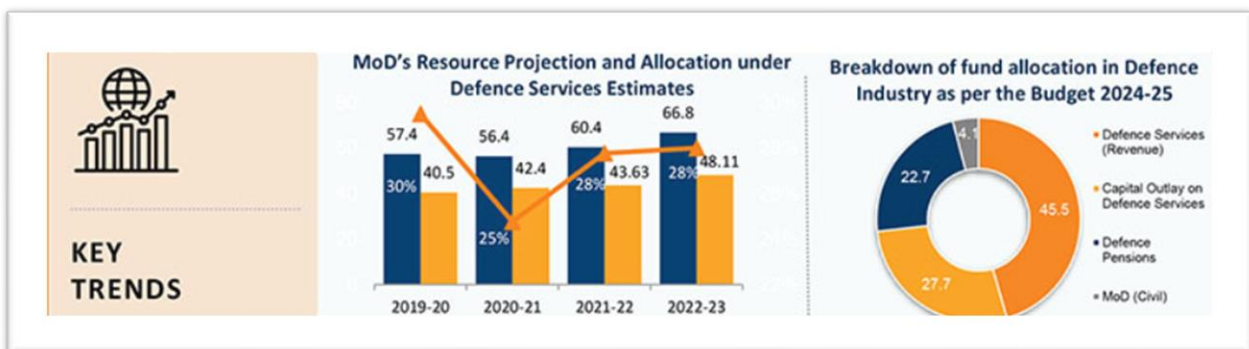
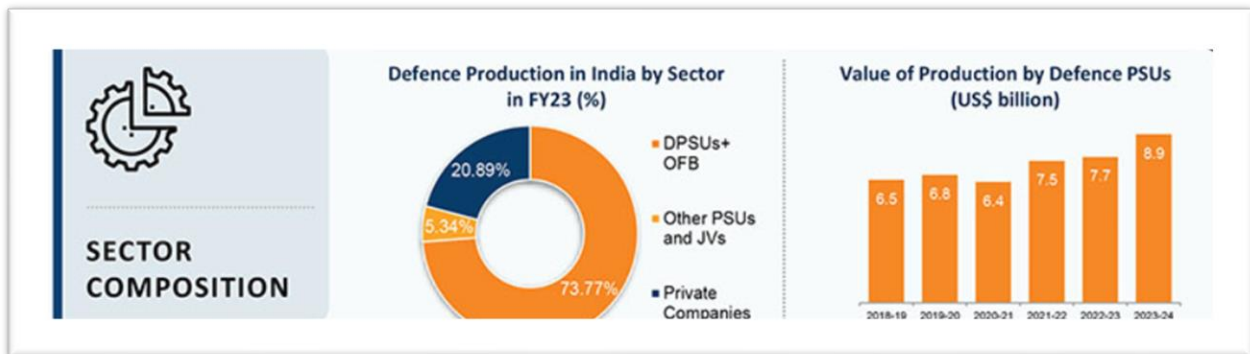

GOVERNMENT

- Increased Cooperation with Vietnam on Surveillance and Shipbuilding Technology
- Defence Production and Export Promotion
- Defence Park in Kerala to Promote MSMEs and Boost 'Make in India' Initiative

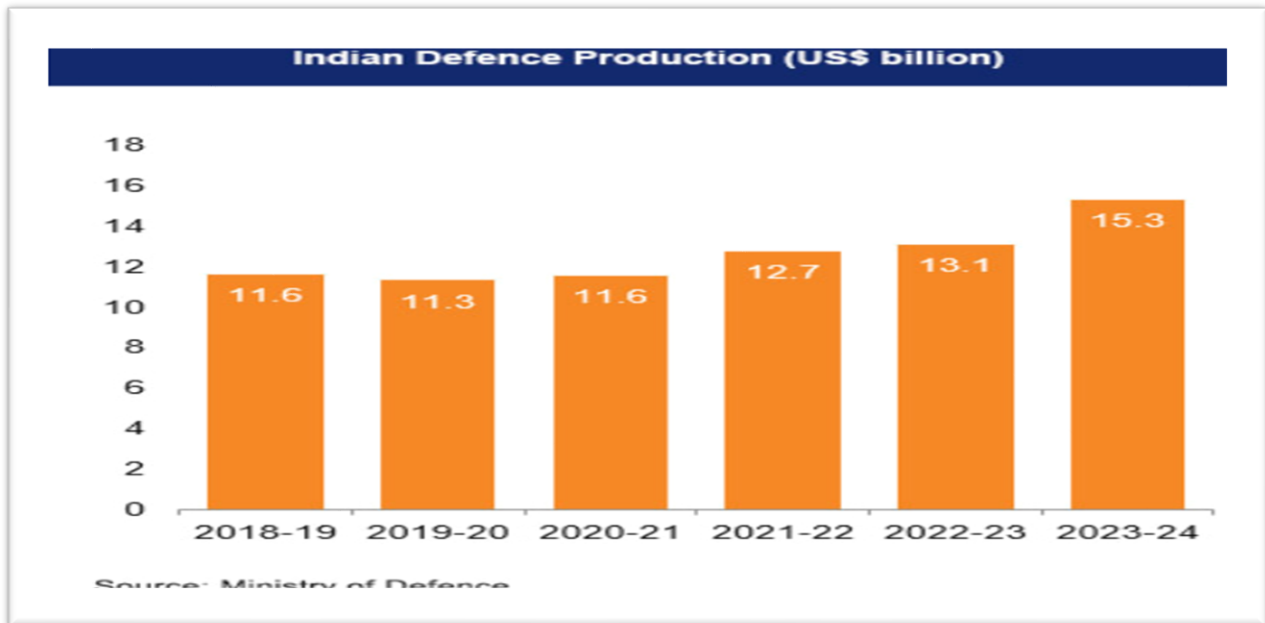

(Source :<https://www.ibef.org/industry/defence-manufacturing>)

Recent Developments/Investments

- In a major boost to Aatmanirbharta in defence & minimise imports by Defence Public Sector Undertakings (DPSUs), Department of Defence Production (DDP), Ministry of Defence has notified the fifth Positive Indigenisation List (PIL) consisting of 346 items. These include strategically important Line Replacement Units/Systems/ Sub-systems/Assemblies/Sub-assemblies/Spares & Components a raw materials, with import substitution value worth Rs. 1,048 crore (US\$ 126.57 million).
- In July 2024, The Defence Research & Development Organisation (DRDO) has awarded seven new projects to industries under its Technology Development Fund scheme. This initiative aims to support the Armed Forces and the aerospace and defense sectors. It highlights DRDO's commitment to fostering industries, particularly MSMEs and start-ups, in these fields. Developing these technologies locally will enhance the military industrial ecosystem.
- In January 2024, Bharat Electronics Ltd (BEL) partnered with the Foundation for Innovation and Technology Transfer (FITT) at IIT Delhi to translate breakthroughs in Naval Deep Tech research into products for the Indian Navy.
- On December 29, 2023, Defence Secretary Mr. Giridhar Aramane inaugurated a new design and test facility Aero Engine Research and Development Centre (AERDC) at Hindustan Aeronautics Limited (HAL) in Bengaluru, Karnataka. AERDC is engaged in designing and developing various engines, including the Hindustan Turbo Fan Engine (HTFE) for trainers, UAVs, and regional jets, and the Hindustan Turbo Shaft Engine (HTSE) for light and medium-weight helicopters.
- In a major move towards achieving India's goal of becoming the 'Global Hub for Green Shipbuilding' by 2030, GRSE signed a MoU in November 2023 with Shift Clean Energy (Shift), Seatech Solutions International (Seatech) and the American Bureau of Shipping (ABS), to develop Electric Tugs E-VOLT 50. The E-VOLT 50 aims to reduce carbon emissions, improve operational efficiency, and set new benchmarks for performance and environmental sustainability in the tugboat industry.

Government Initiative

- The Central government aims to take India's defence exports up to US\$ 5 billion by 2024-25.
- Of the Interim Budget for Financial Year 2024-25, Ministry of Defence has been allocated a total budget of US\$ 74.8 billion (Rs. 6,21,540.85 crore), which is 13.04 % of the total budget. This includes an amount of US\$ 17.0 billion (Rs. 1,41,205 crore) for Defence Pensions. The total Defence Budget represents an enhancement of 4.72% over the Budget of 2023-24 and 18.35% over the allocation for 2022-23.
- Of the Union Budget for Financial Year 2023-24, Ministry of Defence has been allocated a total Budget of US\$ 72.2 billion (Rs. 5,93,537.64 crore), which is 13.18 % of the total budget. This includes an amount of

US\$ 16.8 billion (Rs. 1,38,205 crore) for Defence Pensions. The total Defence Budget represents an enhancement of US\$ 8.3 billion (Rs. 68,371.49 crore) (13%) over the Budget of 2022-23.

- In the Interim Budget 2024-25, the Capital Investment Outlay has been increased by 11.1% to US\$ 133 billion (Rs. 11.1 lakh crore), which would be 3.4% of GDP. This also means tripling of the capital expenditure outlay in the past 4 years.
- In the Union Budget 2023-24, the Capital Investment Outlay has been increased steeply for the third year in a row by 33 per cent to US\$ 121 billion (Rs. 10 lakh crore), which would be 3.3 per cent of GDP. This will be almost three times the outlay in 2019-20.
- As per the Interim Budget 2024-25, the Capital Allocations pertaining to modernization and infrastructure development of the Defence Services increased to US\$ 20.7 billion (Rs. 1,72,000 crore) representing a rise of almost US\$ 1 billion (Rs. 9,400 crore) (5.8%) over 2023-24.

Road Ahead

The Indian government is focussing on innovative solutions to empower the country's defence and security via 'Innovations for Defence Excellence (iDEX)', which has provided a platform for start-ups to connect to the defence establishments and develop new technologies/products in the next five years (2021-2026). Working through partner incubators, iDEX has been able to attract the start-up community to participate in the Defence India Start-up Challenge (DISC) programme.

In an effort to boost the defence sector and increase the infusion of FDI, the government in September 2020 revised the regulations and permitted FDI under the automatic route up to 74% and 100% through the government route in any area, where it is likely to provide access to contemporary technologies. The Defence Ministry has set a target of 70% self-reliance in weaponry by 2027, creating huge prospects for industry players. Green Channel Status Policy (GCS) has been introduced to promote and encourage private sector investments in defence production to promote the role of private sector in defence production. Given the government's emphasis on easing restrictions on foreign investment in order to achieve India's goal of an "Atmanirbhar Bharat", the growth trajectory of the Indian defence sector remain strong.

(Source: <https://www.ibef.org/industry/defence-manufacturing>)

OUR BUSINESS

This chapter should be read in conjunction with, and is qualified in its entirety by, the more detailed information about our Company and its financial statements, including the notes thereto, in the sections titled 'Risk Factors' and 'Financial Information' and the chapter titled 'Management Discussion and Analysis of Financial Condition and Results of Operations' beginning on page nos 20, 140 and 159 respectively, of this Draft Prospectus. Unless the context otherwise requires, in relation to business operations, in this chapter of this Prospectus, all references to "we", "us", "our" and "our Company" are to CFF Fluid Control Limited.

OVERVIEW

Our company "CFF Fluid Control Limited" was incorporated with a vision to serve the requirements of emerging defence sector of the country. We are engaged in the manufacturing and servicing of Submarine machinery, critical component systems and test facilities for Indian Defence PSU Shipyard. On June 12, 2023, our Company vide an Initial Public Offer listed its equity shares on BSE SME Platform embarking its journey of being a public listed company. As on December 31, 2024 we have a robust order book of Rs. 55,160.19 lakhs of which over 90 % pertains to orders from Indian Defence PSU Shipyard (including its OEMs).

Currently, we operate through our manufacturing facilities located at Khopoli, Raigarh which is entirely dedicated to cater the requirements of Indian Defence PSU Shipyard for manufacturing and supplying mechanical equipment for the "Scorpene" Submarine Program of India. Our manufacturing facilities located at Khopoli is spread over 6,000 sq mtrs and is well equipped with all the relevant state of the art machinery and testing facilities. We have in-house capabilities and proficiency in design, manufacturing and providing service for fluid control systems, distributor and air panels, Weapons and Control Systems, Steering gear, Propulsion Systems, High Pressure Air Systems, Hydraulics Systems, Breathing and Diving Air Systems and Integrated Platform Management Systems for submarines and surface ships for the Indian Defence PSU Shipyard and its OEMs.

Further, we have an additional manufacturing facility in pipeline at Chakan Industrial Area, Pune which is spread 1,950 Sq. mtrs and shed of 1,659.28 Sq. mtrs. We plan to initially introduce this exclusive manufacturing setup for production of critical and complex systems such as Towed Array Sonar in agreement with our German partner. CFF Fluid Control Ltd., and Atlas Elektronik GmbH, a division of the German defense giant Thyssenkrupp Marine Systems, have joined forces to produce 12 low-frequency variable depth sonars (LFVDS) for the Indian Defence PSU Shipyard's Anti-Submarine Warfare (ASW) Shallow Water Craft (SWC) program.

Collaboration for Strategic Advantage

The partnership between CFF and Atlas Elektronik signifies a strategic move towards achieving self-sufficiency in the production of critical defense equipment. CFF's expertise in engineering will be combined with Atlas Elektronik's proven sonar technology, resulting in a powerful indigenous ASW solution. This collaboration not only strengthens India's defense capabilities but also fosters technological advancements within the domestic defense sector. The production of LFVDS is a pivotal move in supporting the Indian Defence self-reliance objectives, fostering domestic skill development, and strengthening the national defense ecosystem.

A Step Towards Self-Reliance

The indigenous production of these LFVDS is a significant step forward for the Indian Defence vision of self-reliance. This project not only equips the navy with advanced technology but also creates opportunities for domestic skill development and strengthens the Indian defense ecosystem.

This development comes amidst growing concerns about underwater threats in the region. By bolstering its ASW capabilities, the Indian Defence is well-positioned to address these challenges and ensure the safety and security of its vast coastline.

Our promoters and group companies have been in the defence manufacturing space for more than 20 years. We believe our Engineering and Design capabilities and several years of experience of manufacturing mission critical components and systems of submarines and surface ships for the Indian Defence PSU Shipyard enable us to develop high quality solutions for the defence equipment. We are a technology-driven and innovative company with manufacturing high-quality products which meets the global standards. We have on-payroll employee strength of 237 persons as on September 30, 2024 and we also employ industry professionals for project specific works on professional basis from time to time.

Our Strengths



Visible growth through Robust Order Book Position and Strong financial position

With our continued focus on our core areas, diversification of our skill set, our ability to successfully bid and win new orders and enhancement of order book across diverse critical components and systems required in Indian Defence PSU Shipyard submarines and other ships lines, we are able to pursue a broader range of project tenders and therefore maximize our business volume and contract profit margins. As on December 31, 2024 we have order book of ₹ 55,160.19 lakhs.

We have experienced sustained growth with respect to the key financial indicators as well as a consistent improvement in our balance sheet position. Based on our restated financial statements, our revenue from operations, EBITDA and Profit after tax has grown at a CAGR of 50.80%, 56.92% and 48.65% respectively from 2022 to 2024. The table below sets forth some of the key financial indicators for six months period ended September 30, 2024 and Fiscal 2024 2023 and 2022:

Particulars	For the period ended Sept 30, 2024*	Fiscal 2024	Fiscal 2023	Fiscal 2022
Revenue from Operations	8,003.41	10,685.91	7,066.63	4,698.77
EBITDA	2,303.96	3,085.38	1,882.82	1,252.93
EBITDA Margin (%)	28.79%	28.87%	26.64%	26.67%
Restated profit for the period / year	1,404.61	1,708.78	1,013.60	773.32
Restated profit for the period / year Margin (%)	17.55%	15.99%	14.34%	16.46%
Return on Net Worth (%)	10.10%	13.57%	40.56%	52.06%

*Not Annualised

We also strive to continuously achieve robust order book by adding quality projects with potentially higher margins with emphasis on having a strong balance sheet and increased profitability in future. All these factors would provide us with sustainable growth opportunities and ability to enhance shareholder's value in the future.

High entry barriers in defence manufacturing sector

The Defence Sector has significant entry barriers due to specific factors unique to this sector. Considering, that we manufacture life and mission-critical components and systems, the margin for error is zero in our manufacturing process, which we adhere to by way of our strong quality control systems. Considering that the costs are very high in the defence industry given the stringent quality checks and certifications that are required to qualify a supplier, there are significant entry barriers, which makes finding a manufacturing partner a lengthy process of multiple years for OEMs.

➤ Technical Capabilities:

Further, we have the necessary certifications and registrations with various clients with whom regular business is undertaken. These include Indian Defence PSU shipyards such as Mazagaon Dockyard and Shipbuilders Limited (MDL), Naval Dockyards at Mumbai, and Karwar, Hindustan Shipyard (HSL) at Visakhapatnam and GOA Shipyard Limited. We are also in the process of renewal of registration with Naval Dockyards and Naval Ship Repair Yard at Karwar and in process of registration Garden Reach Shipbuilders and Engineers (GRSE).

For the equipment manufactured and serviced by CFF, we are recognized as the Authorized Equipment Manufacturer by the Indian Defence PSU Shipyard. This enables us to obtain repeat orders for the items and its spares as and when required by the Indian Defence PSU Shipyard. Further this enables us to provide repair services to the Indian Defence PSU Shipyard as a single source vendor. We are the Authorized Equipment Manufacturers for the following:

- (a) Mechanical Equipment for Scorpene submarines (Authorized Equipment Manufacturer)
- (b) Underwater communication equipment for Scorpene Submarines (Authorized Equipment Manufacturer)

In addition, we have a framework agreement with Naval Group (France) which will enable us to support various other equipment and systems for the 30-year life cycle of the submarines. Being an Authorized Equipment Manufacturer and having the necessary framework agreements for licensed production in place will ensure continuity in business for the complete life cycle of the Scorpene submarines. In defence manufacturing there is a concept of “Authorized Equipment Manufacturer”, which means that a particular item whose Authorized Equipment Manufacturer is allocated to a vendor needs to be procured from said vendor only until the completion of the life cycle of the submarine or ship and hence we believe that having Authorized Equipment Manufacturer status for certain items pertaining to Scorpene submarine is a major strength of our company. The above-mentioned technical capabilities, registrations and empanelment would provide a competitive advantage to our company in the future

➤ High -working capital requirements

Given the nature of the industry we operate in and the product we build is component/part of a major defence equipment it can be characterised as capital intensive industry. Since we primarily work for the Indian Defence PSU Shipyard (including its OEMs), the market practice is to provide substantial credit period from our billing cycle and likewise substantial amounts of our funds are required for the long gestation work-in progress inventories and working capital assets we would hold.

➤ Stringent vendor approval process

Defence equipment manufacturers are under strict scrutiny given the safety on nation is relied on it for product quality. Under the Atmanirbhar Bharat Initiative, the Governments sourcing strategy is focused on scalability, reliability of supplies, infrastructure, systems and product quality and systems. Large defence manufacturing companies want to deal with suppliers who have an existing track record. For any change in suppliers, defence manufacturers have a lengthy and expensive process of testing the product to evaluate its impact on the product quality. Hence, there is resistance to change or add any new suppliers, since, the approvals take significant time. Various of our customers have conferred on us the status of preferred supplier, primarily due to our focus on building long term relationships which helps us in achieving higher profits with increase in order volumes.

Further, because of the nature of defence sector, products manufactured by us are typically subject to stringent regulatory and industry standards, any change in the vendor of the product may require significant time and expense on part of the customers, which acts an entry barrier and disincentives any such changes for them.

Focus on Navy Defence Sector and strategic partnership with foreign manufacturer for technological advancement

Defence Industry has its own procedure, rules and regulations for its business activity as it is connected directly to national safety and reputation of the country. GoI has come up with the mission to turn India into a manufacturing hub. When it comes to defence sector there is no room for failure. We need to tackle with the stringent technical standards

required by the equipment to survive extreme conditions. The manufacturing process requires in depth understanding the requirement, prototyping process, high-skilled manpower who specializes on different materials. Maintaining confidentiality in regards to design and delivery is the key necessity. Time horizon of approx 3years is required to empanel and get on board with the customer. Only after surviving all the conditions, we get approved as a vendor for that specific equipment designed and manufactured by us. All the supplies, then will delivered by us during the life period of submarine. For e.g. We would be providing the supply equipment and spares for 30 year life cycle of Scorpene Submarines and such future endeavours would make us preferred choice vendor for Indian Defence PSU Shipyard and hence enable us to generate long term sustainable value creation.

Our Company has established longstanding strategic partnerships with foreign Manufacturers. The partnerships are carefully chosen to bring technology which is not available in India and is the need for the Indian Defence Industry. Our key tie-up is with M/s Nereides, French Company is engaged in the manufacturing of Towed Wire Antenna. We have agreement for technology transfer, process development manufacture of Towed Wire Antennae for Indian Defence PSU Shipyard and also export to foreign countries. Another tie-up is with M/s Atlas Elektronik GmbH, a subsidiary of Thyssenkrupp Marine Systems, is known for its expertise in naval technologies, including sonar systems. A strategic partnership is aimed at promoting the indigenization of sonar technology and other equipment, which is essential for improving national defense capabilities and reducing reliance on foreign technology. We believe this initiative can lead to enhanced performance, reduced costs, and greater control over vital defense technologies.

Experienced Promoters and Management Team

Our Company is led by qualified and experienced Promoters and management team, that we believe has the expertise and vision to manage and grow our business. Our Promoters, Mr. Sunil Menon and Mr. Gautam Makker of have more than three decades of business experience and over two decades of defence sector related experience and have been instrumental in our Company’s growth and development. Our Promoters are ably supported by well-educated and experienced professional management team whose collective experience and capabilities enable us to understand and anticipate market trends; manage our business operations and growth, leverage customer relationships and respond to changes in customer preferences. We will continue to leverage on the experience of our management team and their understanding of the industry we operate in, to take advantage of current and future market opportunities. For further details of the educational qualifications and experience of our promoter and senior management please refer to the chapter titled “*Our Management*’ on page 120 of this Draft Prospectus.

Our Strategies

All the below mentioned strategies are approved by the Board of Directors through Board Resolution dated January 03, 2025.

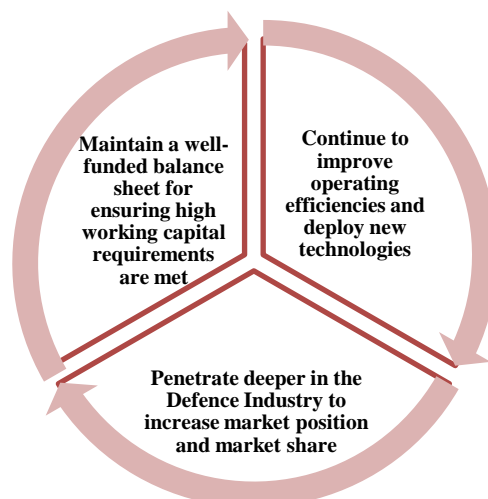

Maintain a well-funded balance sheet for ensuring high working capital requirements are met

With the growth in our order book year on year and holding a order book of Rs. 55,160.19 lakhs to be executed, we intend to continuously augment our capacity in line with our anticipated business growth, and we expect to utilise such augmented capacity including by executing our order book mentioned above. We are dedicated manufacturers for Defence and serve Indian Defence PSU Shipyard (including its OEMs), the market practice is to provide credit periods

of over 3 to 4 months from our billing cycle. Our working capital fund gets tied up in long gestation work-in-progress inventories and debtors and timely payment of creditors to avail best price and maximum possible rebates on our purchases. Therefore, the success in our business is dependent on our ability to ensure we have interest free working capital available to ensure smooth flow of sales and goods for production without the stress and difficulties of funding the same through debt. Hence, we propose to raise FPO funds for ensuring our working capital-intensive business remains well funded in the long term and hence provide a competitive advantage to us in the future.

Penetrate deeper in the Defence Industry to increase market position and market share

Our Company intends to continue to strengthen our capabilities and existing relationships with our current customers and by acquiring more orders to serve the industries. High domestic volumes and consumption will bring in the component ecosystem locally and enhance local capabilities of component sourcing, thus making the ecosystem stronger and closer. The government initiative under Atmanirbhar Bharat Initiative, five positive indigenization lists of 509 products have been promulgated by Department of Military Affairs and Ministry of Defence to be manufactured domestically for the defence sector, instead of being sourced via imports. In the Regular Union Budget of FY25, Ministry of Defence (MoD) has been allocated Rs. 6,21,940.85 crore (approx. US\$ 75 Billion), the highest among the Ministries. (Source: IBEF-Defence)

Our Company is strategically positioned to take advantage of such growing demands in the emerging defence industry. Anticipating increased order, we expect to increase our order taking appetite thus increasing our volumes, revenues and scale of operations. We also continually seek to identify new order and bid for the same for defence components that have economic viability and significant growth potential. We intend to utilise the investment of GoI in defence to capitalize on the unutilized capacity at our manufacturing facilities to further increase production of our products. Leveraging on the technological experience, capabilities, well equipped manufacturing unit and our management along with team we strive to increase the market share of fulfilling order book and enhance our visibility in the domestic market, particularly submarine components.

Continue to improve operating efficiencies and deploy new technologies

We aim to offer quality products at optimal prices to our customers and believe this will enable us to maintain our long-term relationship with customers. We believe that our consistent focus on innovation, technological advancements and capabilities, high quality and cost improvements are key factors that differentiates us from our competitors and enable us to meet global standards. Consistent with past practice, we intend to continue to invest in best technology for our manufacturing processes to increase the overall production efficiency and optimal use of resources to produce with enhanced quality along with reducing downtime and idle time.

We have invested in our manufacturing facility, infrastructure, machines, equipment and technology to allow us to offer a various critical components, reduce operating costs and drive productivity and scale of our business without incurring significant incremental costs in the future. We have positioned ourselves as a technology-driven, self-featured innovative company within the defence component manufacturing industries. We intend to leverage our size and scale to complete order books of our products from each of our existing and upcoming manufacturing facilities and spread our fixed costs.

DETAILS OF OUR BUSINESS

Location

Manufacturing Unit and Registered Office: Plot No. 1 Survey No. 96, Village Kumbhivali, Khalapur, Khopoli (E), Raigad- 410202, India.

We have the state-of-the-art manufacturing facility at our factory. The equipment and processes are approved and qualified by Naval Group (France). The machining centre is capable of handling precision machining. The 10,000 class clean room is capable of handling welding and fabrication of special materials like Titanium and High Nickel-Chromium materials which are used in submarine, nuclear and space applications. Other equipment such as Tig Welding Machine, Water jet cutting machines, Heat treatment furnaces etc are available to support the fabrication works. Design software's complement the CAD-CAM environment required for manufacturing the components.



Factory at Pune: PAP-B-116/1, Chakan Industrial Area, Phase-II, Bhamboli, Khed, Pune-410501.



Products and Services

Our current business model is focused in **Navy- Submarines**. Our supplies include-

- Fluid Systems for Submarines, Naval Vessels
- Antenna and Navigation Systems for Submarines and
- Weapon Systems (Torpedo, Tubes and Fire Control)

Our Company manufactures a wide range of products which can be classified into following categories:

1. **Sonar System:** Indigenous systems for superior underwater detection, developed in collaboration with Atlas Elektronik, Germany.



2. **DE-GT Exhaust Infrared Suppression System:** Designed to enhance the stealth capabilities of surface ships, this system is developed indigenously under the “Make in India” initiative.



3. **Steering Gear System:** Ensuring reliable navigational control for submarines and surface vessels, CFF, in partnership with Naval Group France, supplies critical components and services for the steering gear systems aboard submarines.

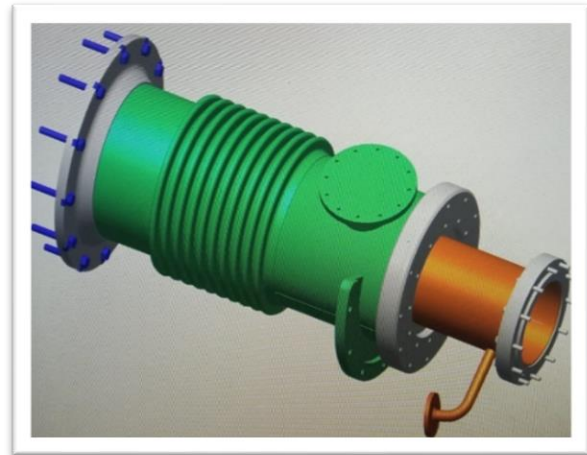
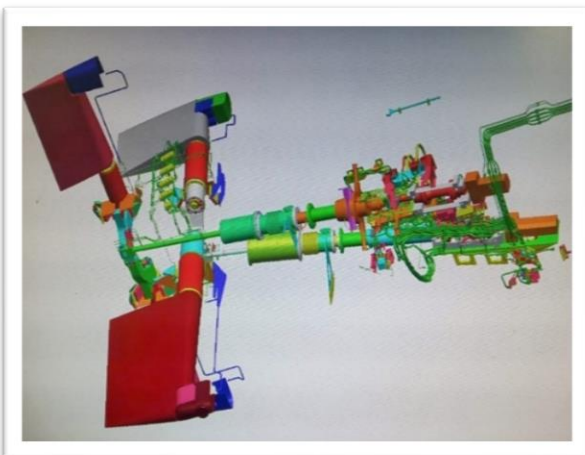

4. **Torpedo Launching System:** A precision-engineered system for torpedo and missile launching, designed to manage weapon storage and accommodate compensatory weight adjustments post-launch.

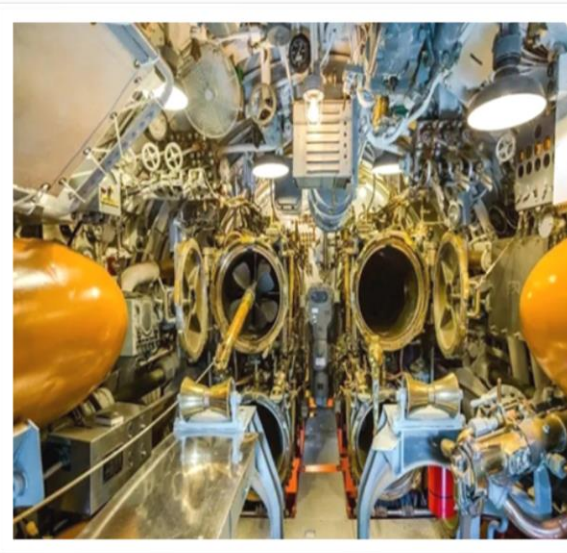
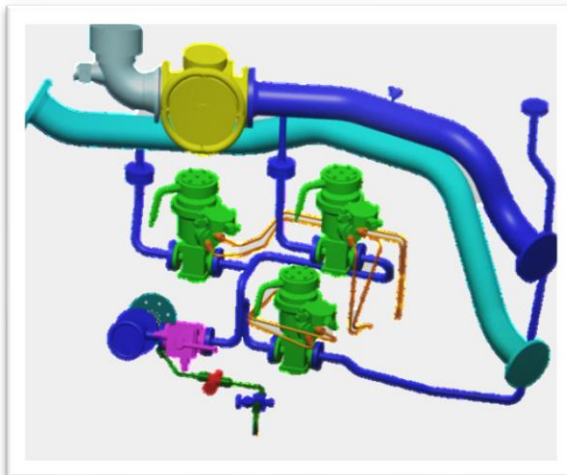
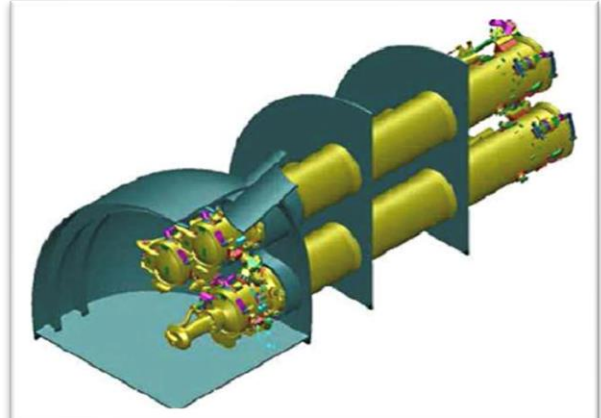
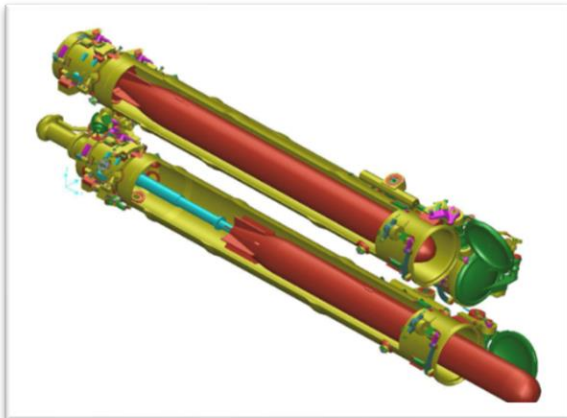

5. **Buoyant Wire Antenna System:** A seamless underwater communication solution, developed under a technology transfer agreement with Nereides, France.

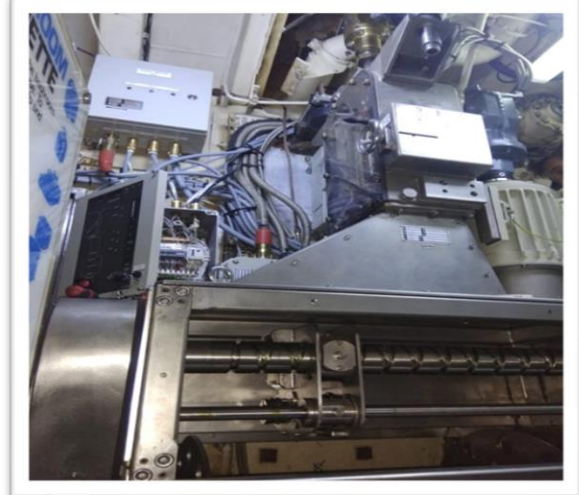
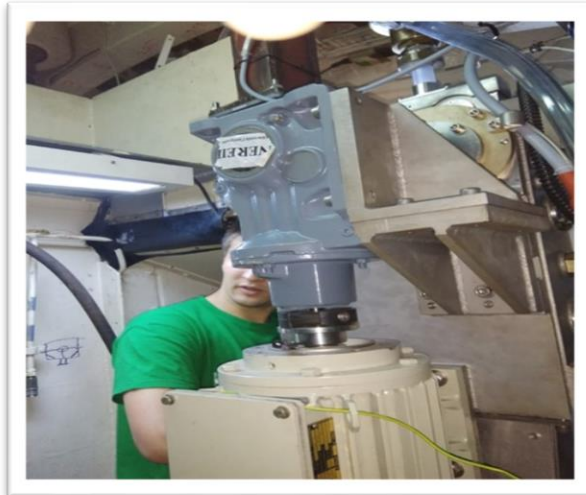
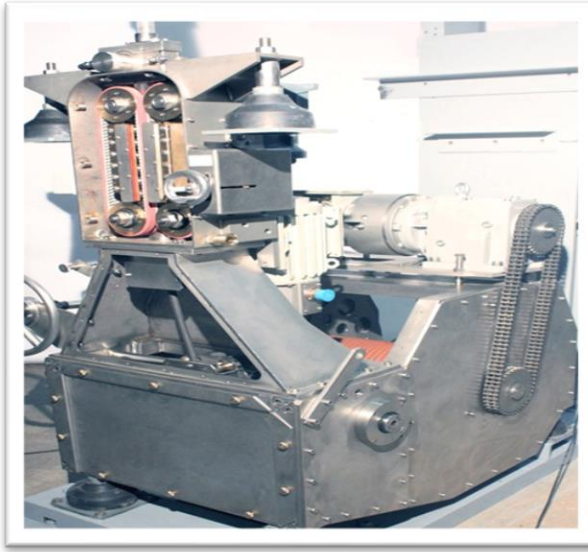

6. **HVAC System:** Ensures optimal onboard living conditions for crew and equipment. CFF manufactures, integrates, installs, and conducts Sea Trials for the turnkey HVAC system aboard Indian Defence PSU Shipyard vessels, including STW and HATS.

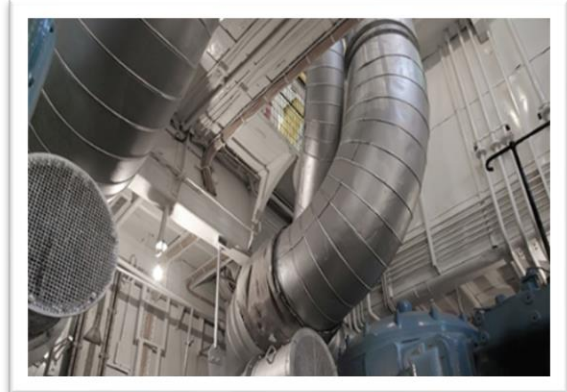

7. **Submarine Diesel Engine Intake and uptake Exhaust System:** System used for the directing the Diesel Engine generator exhaust gases while charging the batteries. CFF designs, manufactures all parts and components and installs the system including Sea Trials.

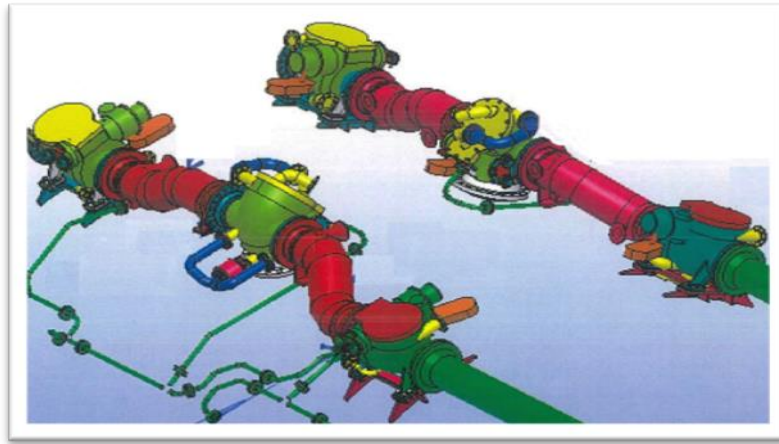

8. **Integrated Platform Management System (IPMS):** Advanced system for integrated control and monitoring of vessel operations, enhancing operational efficiency and safety.

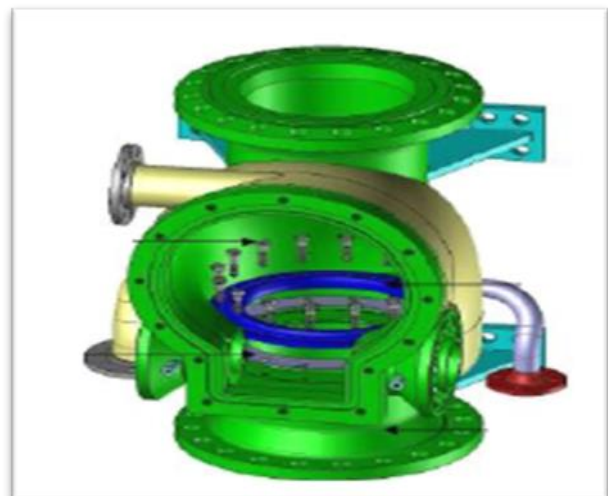
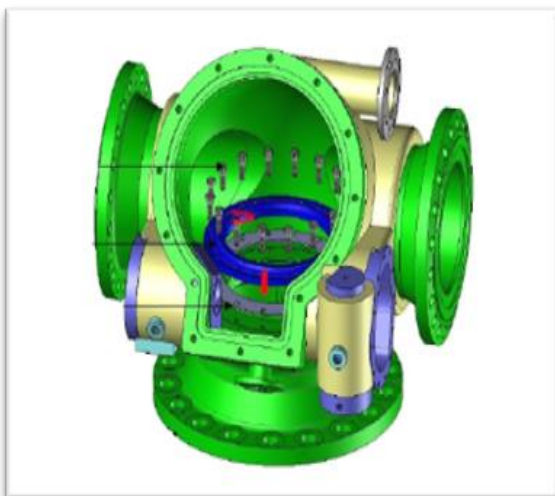
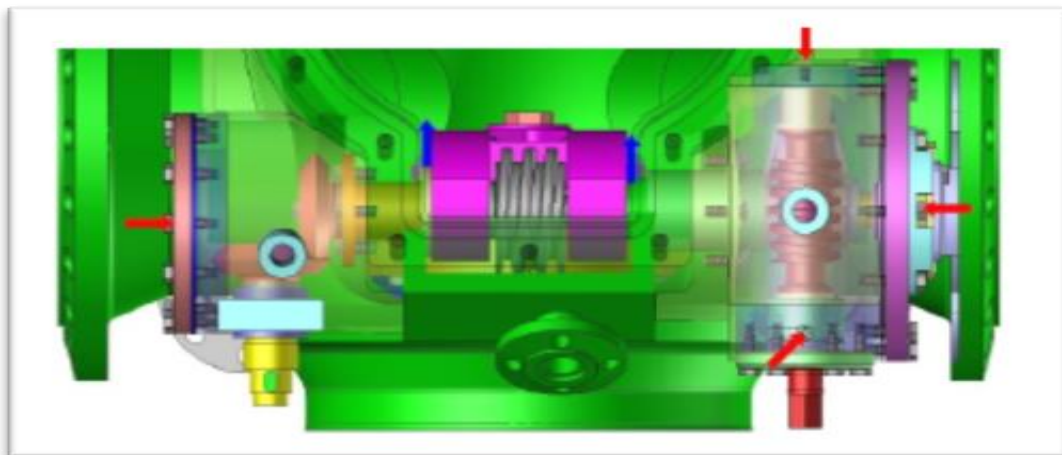

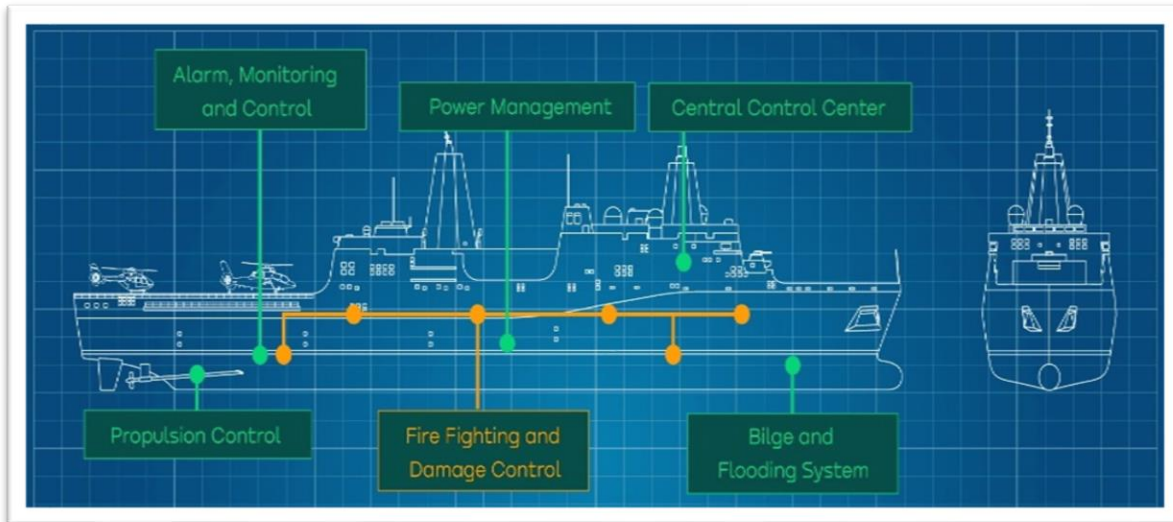

9. **Major Refit Life Cycle:** CFF's scope includes comprehensive structural restoration, including hull integrity; overhaul of propulsion, HVAC, and power systems; and the modernization of communication, navigation, and weapons systems to ensure continued operational readiness.

Manufacturing Process

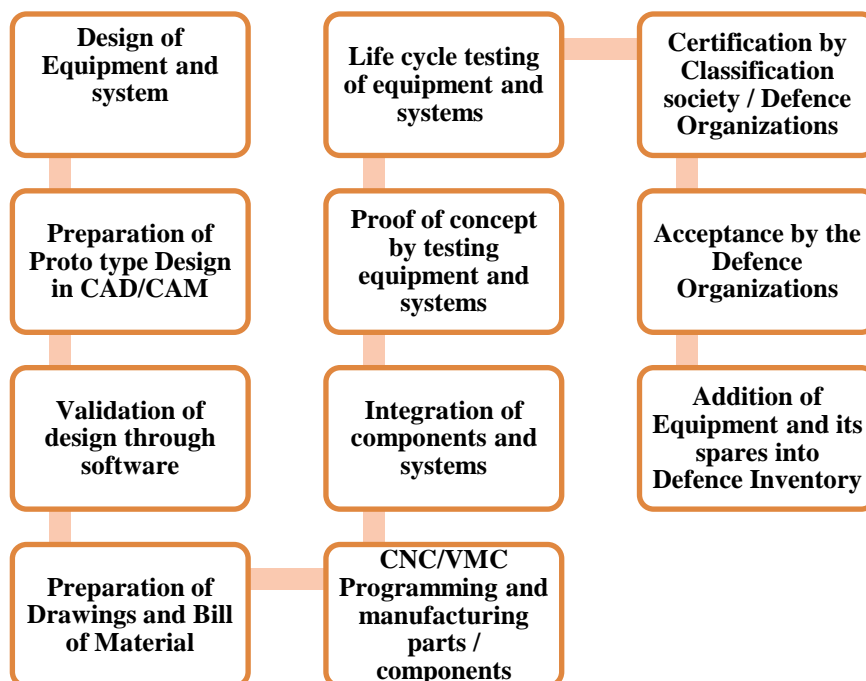

We have built our design and engineering department and ventured into complete system integration. In the above process products are prototyped, developed, functionally tested, validated, environmentally tested in compliance with stringent requirements of the Defence and Nuclear Industry. We have separate division that undertakes repairs and overhaul of valves and equipment delivered by us.

The equipment and systems are designed to meet the stringent requirements of the Defence Industry. We have a capable design team which is well versed with understanding the various technical standards and to undertake the design meeting the stringent defence technical standards. The design is undertaken on various software held by us.

On completion of design, the equipment / components are to be manufactured. Detailed technical specifications of the raw material and equipment are prepared. Required material is procured and components are manufactured as per production drawings issued to the production shop floor.

The components / parts are thereafter assembled as per the assembly drawings provided by the design department. The prototype equipment / systems are made ready for physical inspection prior undertaking functional trails.

The Prototype thereafter undergoes functional trials as per the requirements specified by the Defence Forces. Required test beds are custom built and quality standards are met and demonstrated to the defence quality assurance organization. Life cycle tests are performed to ensure reliability of the product. Stringent testing on equipment withstanding vibration and shock resembling missile explosions in near by area are performed. The equipment has to perform satisfactorily in shock and vibration conditions. This key factor distinguishes the defence equipment from commercial equipment. Careful design and manufacturing is essential to ensure equipment qualifying the stringent defence standards.

On successful acceptance of prototype, clearance is issued for bulk production. Equipment once manufactured are offered for quality inspection by the client. On successful acceptance, equipment are packed and dispatched to the client for installation onboard the ships and submarines. During commissioning of the equipment and systems, our services are offered to ensure equipment functions as desired.

Key Business Process

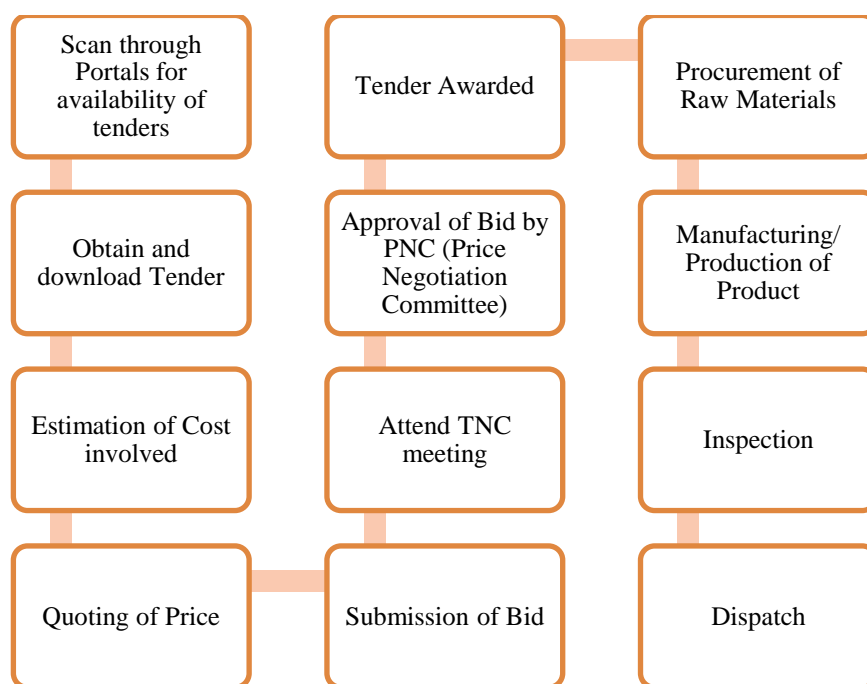

Plant and Machinery

Following are the details of the equipments being used for business:

Sr.no	Description
1.	5 Axis CNC VMC
2.	5 Axis Haas Control
3.	4 Axis Haas Control
4.	4 Axis MCV 400
5.	Ace Bed CNC
6.	Ace CNC Lathe Model
7.	Ace Turn Mill Centre
8.	Air Compressor
9.	Air Compressor
10.	Apex Cmm Machine
11.	Band Saw Machine

Sr.no	Description
12.	Battery Operated Floor Crane
13.	Bench Grinder
14.	Blasting Machine KSB-AST 750
15.	BMV VMC
16.	Camrac Welding
17.	Carbide Endmill Cutter
18.	Clean Room & Intercom System
19.	CNC Band Saw Machine
20.	CNC BMV
21.	CNC Lathe
22.	CNC MCV
23.	CNC Turning Centre
24.	Cng Vertical Machining Center
25.	Computerised Bench Machine
26.	Consul Digital Power Conditioner Model VXX
27.	Conventional Lathe Machine
28.	Crane 5 Ton
29.	Crysta Apex
30.	Crysta Plus
31.	D5.Scvt 450dst 49 (Fork Lift)
32.	DG 200KVA
33.	Doosan Cmm
34.	Dryer
35.	Electric Generator
36.	EOT Crane
37.	Foot Operated Ponemeter
38.	Gate Valve Body
39.	Grinding Machine
40.	Hydraulic Torue Wrench (Test Bench)
41.	Hydraulic Bolt Tightner
42.	Hydraulic Flushing System
43.	Hydraulic Fork Lift
44.	Hydraulic Oil Filtration Systems
45.	Hydraulic Power Pack for Oil Testing
46.	Hydraulic Press Machine
47.	Hydro Hand Pallet Tract
48.	Hydro Pneumatic Power Pack
49.	Lazer Marking Machine
50.	Marking Machine
51.	Oil Testing Table
52.	Orbital Welding Machine
53.	Orbmatic Spares Closed
54.	Pneumatic Compressor
55.	Powe Back (Ups)
56.	Power Pack Test Bench
57.	Pressure Test Units
58.	Pump Power Pack
59.	Racks
60.	Radial Drilling Machine
61.	3D Scanner
62.	Roller Shulter
63.	Rolling Machine
64.	Servo Voltage Stabilizer
65.	Shot Blasting Machine
66.	Sigma Weld
67.	Stanco Lathe
68.	Testing Equipment

Sr.no	Description
69.	Tig Welding Machine
70.	Transformer
71.	Turn Mill LT2LM 500MY
72.	Ultrasonic Cleaning Machine
73.	Valve Endurance Testing
74.	Vertical Milling Machine
75.	Vibratory Cleaning Machine
76.	Vibro Machine Vs2-200
77.	Weighing Scale
78.	Welding Machine

Raw Materials

Our major raw materials are Nickel- Aluminium- Bronze (NAB), Copper- Nickel (CUNI), Copper- Aluminium (CUAL), and Titanium. We have been able to secure timely supply of required materials for our existing activity. We fetch raw material from both domestic and international markets and no difficulty is envisaged in sourcing it.

Utilities

Water

Water is a key and indispensable resource requirement in our manufacturing process. Our Company has made adequate arrangements to meet its water requirements. Water requirement at our manufacturing facility is met through tube-well pump owned by the company.

Power

Our manufacturing units have adequate power supply from Maharashtra State Electricity Distribution CO. Ltd. We have a sanctioned load of 760 KW at our manufacturing unit located at Survey No 96, Kumbhivali Tal, Khalapur, Raigad.

Technological Collaborations for Indigenization

Our strategy is to foster technological innovation and deliver advanced products tailored for the defense sector. We continuously focus on developing products using better technology by entering into partnership with foreign vendors. In alignment with the Government of India's Make in India initiative, we are committed to shifting from imported defense components to domestically produced solutions. Given the stringent requirements of the defense industry, including high-quality standards and specialized manufacturing conditions, we have partnered with few international vendors to acquire cutting-edge technology, processes, and intellectual property for indigenization.

Through these collaborations, we have been able to supply critical components and systems for the Scorpene Submarine Program and other defense projects. Our expertise in research and development, alongside technological transfer agreements, allows us to produce and support the manufacturing of components such as valves, hydraulic systems, gearbox assemblies, titanium air bottles, and towed wire antenna systems, all of which are integral to the operations of the Indian Submarine fleet.

Nereides (France)

Nereides specializes in towed wire antenna systems for submarines, enhancing underwater communication capabilities. These systems allow submerged submarines to receive communications across various frequencies, including VLF, LF, HF, LORAN C, and GPS, while also transmitting in HF. Through a technology transfer agreement, CFF is indigenizing this system under the Make in India initiative, improving the operational capabilities of Indian submarines and reducing their acoustic signature.

Atlas Elektronik GmbH (Germany)

Atlas GmbH, a subsidiary of Thyssenkrupp Marine Systems, is renowned for its expertise in naval electronics, including sonar systems, mine countermeasures, torpedoes, and combat management systems. CFF has entered into a strategic teaming agreement to indigenize key technologies such as the ACTAS (Active Towed Array Sonar) and LFVDS (Low-Frequency Variable Depth Sonar) systems, critical for enhancing India's Anti-Submarine Warfare (ASW) capabilities under the Make in India program.

Naval Group (France)

As a key partner in the P-75 Scorpene Submarine Program, Naval Group has transferred essential technology to CFF for the manufacture of submarine components in India. This partnership is designed to support the indigenization of defense solutions, ensuring the supply of critical systems for the Indian Defence under the Make in India initiative. Our collaboration with Naval Group further strengthens our position as a key supplier of high-precision, mission-critical components for the Indian defense sector.

Capacity Utilisation

We are in the business of manufacture, overhaul, repairs and maintenance of shipboard machinery, combat systems, reference systems, test facilities for submarines & surface ships for the Indian Defence PSU Shipyard. Our Company also deals in business of design, manufacture, sales and service of Marine and Industrial Mech. Equipment's and Systems. Our end product is customized as per client's requirement. It's not a continuous process. Therefore, due to the nature of business in which our Company operates it is difficult to ascertain the exact installed capacity and capacity utilization

Performance Security and Defect Liability

We are usually required to provide a guarantee equal to a fixed percentage of the contract price as the performance security. During the warranty period after the deliveries, we are usually required to cure manufacturing defects, except usual wear and tear, at our own risk and costs. We are usually responsible for curing the defects during the defect notification period, which is usually for a period of 12 to 60 months after delivery. In the event we are unable to cure the defects, our clients usually have the right to get the defect rectified by a third party at our cost.

Liquidated Damages

We are usually required to pay liquidated damages for delays in completion of project milestones, which are often specified as a fixed percentage of the contract price. Our clients are entitled to deduct the amount of damages from the payments due to us.

Key Registrations and Certifications etc

Sr. No.	Description	Registration certificate number	Validity
1.	Registration with Mazagon Dock Shipbuilders Limited	1010545	July 13, 2025
2.	Registration with The Admiral Superintendent (Naval Dockyard)	SR-1185-E	November 02, 2024*
3.	Registration with Controller Procurement Material Organisation (Kawar)	S5730D	N.A
4.	Registration with Controller Procurement Material Organisation (Mumbai)	S5730D	N.A
5.	Registration with Hindustan Shipyard Ltd (Visakhapatnam)	107382	May 26, 2027
6.	Registration with Naval Ship Repair Yard (Karwar)	PB/1123/032-SP	November 02, 2024*
7.	GOA Shipyard Limited	GSL/QAR/PROJ/2024-25/C-437	November 15, 2027

* Under renewal

Our Major Customers

The percentage of income derived from our top customers for the period ended September 30, 2024 and for financial year 2023-24, 2022-23 and 2021-22, based on revenue from sale of products and services is as given below:

(₹ in lakhs)

Particulars	For period ended September 30, 2024		F.Y 2023-24		F.Y 2022-23		F.Y 2021-22	
	Revenue	%	Revenue	%	Revenue	%	Revenue	%

Particulars	For period ended September 30, 2024		F.Y 2023-24		F.Y 2022-23		F.Y 2021-22	
	Revenue	%	Revenue	%	Revenue	%	Revenue	%
Income from Top 5 Customer	7,310.91	91.35%	10,465.78	97.94%	7,066.63	100.00%	4,649.01	98.94%
Income from Top 10 Customer	8,003.41	100.00%	10,85.91	100.00%	7,066.63	100.00%	4,698.77	100.00%

We constantly try to address the needs of our customers for maintaining a long-term working relation with the customers, in order to get continuous business.

Export and Export Obligations

Our company does not have any export obligation.

Competition

We operate in a competitive environment and we expect to face greater competition from existing competitors located both in India and globally, and in particular from companies in United States and Germany. We compete on the basis of our ability to fulfil our contractual obligations including the timely delivery of complex products manufactured by us and the price and quality of such products. Some of our competitors have more resources than us, while certain competitors may have lower cost of operations. In addition, certain competitors may have competitive advantages in manufacturing certain types of precision products compared to us. However, we believe we have a competitive edge with our precision engineered components and assemblies catered to the Indian Defence and given that some of the products manufactured by us are on a single tender basis.

Sales and Marketing

Our company has evolved from a modest component manufacturer to a full-fledged provider of advanced solutions for naval and submarine systems. Our strategy is to bring technological innovation and new efficient products which are to be used in defence sector. We continuously focus on developing products using better technology by entering into partnership with foreign vendors. GOI has established Make in India programme for the defence sector. As the products were before imported for the submarine project, we are trying to make arrangement for production of such components in India. Defence sector has stringent conditions and specific requirements to be fulfilled for their products and therefore need a dedicated unit. We have entered into various collaborations with foreign vendors for supply of their technology, products, process and other relevant intellectual property rights, which will enable us to manufacture required products domestically. We have supplied components, parts, mechanical equipments and services for the Scorpene Submarine project with the technology acquired during the years and continuous research and product development.

Our Company has carved a niche as a reliable and innovative partner in the defense sector, delivering cutting-edge solutions that align with India's strategic goals of self-reliance. Its commitment to quality, partnerships with global and domestic defense leaders, and robust financial performance underscore its status as a trailblazer in indigenous engineering. As the company continues to expand its offerings and geographical reach, it remains steadfast in its mission to support meaningfully to the nation's defense capabilities.

The company's comprehensive product portfolio caters to a wide range of critical naval and submarine applications, including sonar systems, high-pressure air systems, integrated platform management systems, and torpedo launching mechanisms. Its state-of-the-art manufacturing facilities, emphasis on innovation, and commitment to quality have established it as a trusted partner to domestic shipyards and global defense giants. With a strong geographical presence across India and a dedicated team of 237 professionals, our Company is poised to address the lifecycle needs of Indian Defence ships and submarines while adhering to the most stringent defense standards.

Manpower

We consider our human resource as a critical factor to our success and engage in a human resource strategy that focuses on recruiting, training and retaining our employees, as well as offering them competitive compensation. Our Company aims to recruit a talented and qualified work force, facilitate their integration and encourage development of their skills

in order to facilitate the growth of our operations. We are also committed to providing an empowering environment that motivates and facilitates growth and rewards contribution. As on September 30, 2024, we had 237 full time employees.

The detailed break-up of our employees is summarized as under:

Sr. No.	Category	Number of Employees
1.	Executive Director	1
2.	Key Managerial Personnel (KMP)	3
3.	Marketing and Administration	22
4.	Quality Team	15
5.	Design and Engineering	22
6.	Production/ Manufacturing- Engineers	37
7.	Production/ Manufacturing- Skilled	72
8.	Production/ Manufacturing- Semi-Skilled	43
9.	Production/ Manufacturing- Unskilled	22
Total		237

Intellectual Properties

Our intellectual property rights are important to our business. Following are the details of intellectual property owned by us:

TM Type	Application No.	Date of Filing	Class
Logo	5671413	Nov 07, 2022	Class 42
Logo	5671412	Nov 07, 2022	Class 7
Name	5671411	Nov 07, 2022	Class 42
Name	5671410	Nov 07, 2022	Class 7

Further please refer to the chapter titled “Risk Factors” for information in relation to the risk w.r.t. our intellectual property, on page 20 of this Draft Prospectus.

Properties

Owned

Following are the details of properties owned:

Sr. No.	Particulars of the Property	Usage
1.	Plot No. 1 Survey No. 96, Village Kumbhivali, Khalapur, Khopoli (E), Raigad- 410202, India. Area: 6266 Sq. mtrs. (Acquired on December 22, 2015 from Flash Forge Private Limited, who is related party for an amount of 211.00 lakhs)	Used as Registered office and Factory
2.	Flat No. 2202, “B” Wing, Adonia Building, Hiranandani Gardens, Powai, Mumbai - 400076 entered on August 16, 2022. Area: 1600 Sq. ft (Acquired on August 16, 2022 from Melronia Hospitality Private Limited, for an amount of 871.20 lakhs)	Guest House

Leased

Following are the details of properties leased:

Sr. no.	Date of Agreement and Licensor	Particulars of the property, description and area	Consideration/ License Fee/Rent	Lease Period	Usage
---------	--------------------------------	---	---------------------------------	--------------	-------

Sr. no.	Date of Agreement and Licensor	Particulars of the property, description and area	Consideration/ License Fee/Rent	Lease Period	Usage
1.	September 27, 2022 Ms Iyer Priya Muralidharan and Mr. Muralidharan Jagdish	503, Delphi, A wing Hiranandani Business Park, Powai Mumbai- 400076. Area: 4160 Sq. ft	Security Deposit: ₹ 16,64,000/- Rent of ₹ 6,14,622/- per month (and annual increase of 5%.	October 01, 2022 to September 30, 2027	Used for Corporate office
2.	September 04, 2024 M/s Janprabha Industries (Prop: Mrs Prabhavati Janardhan Sathe)	PAP-B-116/1, Chakan Industrial Area, Phase- II, Bhamboli, Khed, Pune Area: 1,950 Sq. mtrs and shed of 1,659.28 Sq. mtrs	Security Deposit: ₹ 28,00,000/- Rent of ₹4,99,942/- per month (and annual increase of 6%.	September 01,2024 to August 31, 2029	Proposed Manufacturing Unit
3.	August 22, 2024 Mr Mirpuri Arun Gobindram and Mrs Mirpuri Pooja Gobindram	C/1006, 10 th floor, Atlantis CHS Ltd, CTS no:5, Hiranandani Gardens, Powai Mumbai – 400076 Area: 900 Sq. ft	Security Deposit: ₹ 4,00,000/- Rent of ₹1,10,000/- per month (and annual increase of 5%.	August 25, 2024 to August 24, 2026	Guest House
4.	August 20, 2024 Suyash Keshav Gorde	Flat No:1 and 5, M.K. Apartment, Shivam Park, Khed, Pune - 410501	Security Deposit: ₹ 7,500/- Rent of ₹5,500/- per month per flat	September 11,2024 to August 10, 2025	Staff Residence
5.	November 08, 2024 Mr Chalamani M Balaraju	1392/V/1 on 5 th floor, Durga Heights, Karwar, Uttar Kannada District. Carpet Area: 910 Sq.ft	Security Deposit: ₹ 32,000/- Rent of ₹ 17,640/- per month (and annual increase of 5%.	October 14, 2024 to September 13, 2025	Staff Residence

Insurance

Our business operations are subject to hazards inherent in manufacturing facilities such as risk of equipment failure, work accidents, fire, earthquakes, flood and other force majeure events, acts of terrorism and explosions including hazards that may cause injury and loss of life, severe damage to and the destruction of property and equipment and environmental damage.

We maintain insurance policy from Oriental Insurance Company Ltd. The details of Insurance policy are as under:

Type of Insurance	Assets Insured	Period	Sum Insured (in lakhs)
Burglary First Loss Policy	Stock	24-June 2024 to 23 June 2025	6,000.00
United Value Udyam Suraksha Policy -Fire	Stock	24-June 2024 to 23 June 2025	6,000.00
United Bharat Griha Raksha Policy	Flat at Powai	03-March 2024 to 02-March 2025	1,000.00
United Value Udyam Suraksha Policy	Plant and Machinery and Buildings at Khopoli	08-March 2024 to 07-March 2025	3,300.00

We may also be subject to product liability claims if the products that we manufacture are not in compliance with the terms of our contractual arrangements. Our policies are subject to customary exclusions and deductibles. See “*Risk Factors - Our insurance cover may not adequately protect us against all material hazards and accidents.*” on page 20.

KEY REGULATIONS AND POLICIES

The following description is an overview of certain sector-specific relevant laws and regulations in India which are applicable to the operations of our Company and our Subsidiary and its business. The description of laws and regulations set out below is not exhaustive and is only intended to provide general information to Bidders. The information in this section is neither designed nor intended to be a substitute for professional legal advice and investors are advised to seek independent professional legal advice.

The statements below are obtained from publications available in the public domain based on the current provisions of applicable Indian law, and the judicial, regulatory and administrative interpretations thereof, which are subject to change or modification by legislative, regulatory, administrative, quasi-judicial or judicial decisions/actions and our Company and our Subsidiary are under no obligation to update the same.

A. INDUSTRY RELATED LAWS AND REGULATIONS

The Information Technology Act, 2000 and the rules made thereunder

The Information Technology Act, 2000 (the “IT Act”) was enacted with the purpose of providing legal recognition to transactions carried out by various means of electronic data interchange involving alternatives to paper-based methods of communication and storage of information. The IT Act also seeks to facilitate electronic filing of documents and create a mechanism for the authentication of electronic records through digital signatures. The IT Act prescribes punishment for publishing and transmitting obscene material in electronic form. It provides for extraterritorial jurisdiction over any offence or contravention under the IT Act committed outside India by any person, irrespective of their nationality, if the act or conduct constituting the offence or contravention involves a computer, computer system or computer network located in India. The Information Technology (Procedure and Safeguards for Blocking for Access of Information by Public) Rules, 2009 specifically permit the Government of India to block access of any information generated, transmitted, received, stored, or hosted in any computer resource by the public, the reasons for which are required to be recorded by it in writing.

Under the Information Technology Act, 2000, we are subject to civil liability to compensate for causing wrongful loss or wrongful gain to any person, while possessing, dealing or handling any sensitive personal data or information in a computer resource owned, controlled or operated by us due to negligence in implementing and/or maintaining reasonable security practices and procedures.

The IT Act and the Information Technology (Amendment) Act, 2008, which amended the IT Act, facilitate electronic commerce by recognizing contracts concluded through electronic means, protects intermediaries in respect of third-party information liability under specified circumstances, and creates liability for failure to protect sensitive personal data. The IT Act also prescribes civil and criminal liability including fines and imprisonment for computer related offences including those relating to unauthorized access to computer systems, tampering with or unauthorized manipulation of any computer, computer system or computer network and, damaging computer systems and creates liability for negligence in dealing with or handling any sensitive personal data or information in a computer resource and in maintaining reasonable security practices and procedures in relation thereto.

In April 2011, the Department of Information Technology, Ministry of Electronics and Information Technology, Government of India (“DoIT”), in exercise of its power to formulate rules with respect to reasonable security practices and procedures and sensitive personal data, notified the Information Technology (Reasonable Security Practices and Procedures and Sensitive Personal Data or Information) Rules, 2011 (“SPDI Rules”) in respect of Section 43A of the IT Act, which prescribe directions for the collection, disclosure, transfer and protection of sensitive personal data by a body corporate or any person acting on behalf of a body corporate. Under the SPDI Rules, sensitive personal data is defined to include personal information relating to passwords, financial information such as bank account or credit card or debit card or other payment instrument details, physical, physiological, and mental health condition, sexual orientation, medical records, biometric information and so on.

The SPDI Rules require every such body corporate, or person acting on behalf of a body corporate, to provide a privacy policy for collecting, receiving, possessing, storing, handling, and dealing with personal information, including sensitive personal data, ensuring security of all personal data collected by it and publishing such policy on its website. The SPDI Rules further require that all such personal data be used solely for the purposes for which it was collected, and any collection or third-party disclosure of such data is made with the prior consent of the information provider, unless contractually agreed upon between them or where such disclosure is mandated by law.

The Micro, Small and Medium Enterprises Development Act, 2006 (“MSME Act”)

MSME Act was enacted to provide for facilitating the promotion and development and enhancing the competitiveness of micro, small and medium enterprises. Any person who intends to establish (a) a micro or small enterprise, at its discretion; (b) a medium enterprise engaged in providing or rendering of services may, at its discretion; or (c) a medium enterprise engaged in manufacture or production of goods pertaining to any industry specified in the First Schedule to the Industries (Development and Regulation) Act, 1951 is required to file a memorandum before such authority as specified by the State Government or the Central Government. The form of the memorandum, the procedure of its filing and other matters incidental thereto shall be such as may be specified by the Central Government, based on the recommendations of the advisory committee. Accordingly, in exercise of this power under the MSME Act, the Ministry of Micro, Small and Medium Enterprises notification dated September 18, 2015 specified that every micro, small and medium enterprises is required to file a Udyog Aadhar Memorandum in the form and manner specified in the notification.

Consumer Protection Act, 2019 (the “Consumer Protection Act”) and the rules made thereunder

The Consumer Protection Act, which repeals the Consumer Protection Act, 1986, was designed and enacted to provide simpler and quicker access to redress consumer grievances. It seeks, inter alia to promote and protects the interests of consumers against deficiencies and defects in goods or services and secure the rights of a consumer against unfair trade practices, which may be practiced by manufacturers, service providers and traders. The definition of “consumer” has been expanded under the Consumer Protection Act to include persons engaged in offline or online transactions through electronic means or by tele-shopping or direct-selling or multi-level marketing. One of the substantial changes introduced by Consumer Protection Act is inclusion of the e-commerce industry under Consumer Protection Act with “e-commerce” defined to refer to the buying and selling of goods or services over digital or electronic network. Therefore, the Consumer Protection Act aims to cover entities that are involved in the process of selling goods or services online. It provides for the establishment of consumer disputes redressal forums and commissions for the purposes of redressal of consumer grievances. In addition to awarding compensation and/or passing corrective orders, the forums and commissions under the Consumer Protection Act, in cases of misleading and false advertisements, are empowered to impose imprisonment for a term which may extend to two years and fine which may extend to ten lakhs. In cases of manufacturing for sale or storing, selling, or distributing or importing products containing an adulterant, the imprisonment may vary between six months to seven years and fine between one lakh to ten lakh depending upon the nature of injury to the consumer.

Bureau of Indian Standards Act, 1986

The Bureau of Indian Standards Act, 2016 (the "BIS Act") provides for the establishment of a national standards body for the harmonious development of the activities of standardization, conformity assessment and quality assurance of goods, articles, processes, systems and services. The BIS Act provides for establishment of Bureau of Indian Standards which will formulate, implement and certify certain standards of quality for goods, services, articles, processes and systems. The Government of India, through Ministry of Consumer Affairs, Food & Public Distribution and the Ministry of Electronics & Information Technology, amongst others, regulate manufacturing or storing for sale, import, selling or distribution of goods which do not conform to the Indian Standard specified in the BIS Act, by way of passing orders. The orders can provide for compulsory registration for undertaking any of the specified activities relating to an identified category of product.

The Digital Personal Data Protection Bill, 2022 (“Data Protection Bill”)

The Central Government has released the draft Data Protection Bill on November 18, 2022. The Data Protection Bill provides for collection and processing of digital personal data by companies. According to the Data Protection Bill companies collecting and dealing in high volumes of personal data will be defined as significant data fiduciaries. These significant data fiduciaries will be required to fulfil certain additional obligations under the Data Protection Bill including appointment of a data protection officer who will be the point of contact between such fiduciaries and individuals for grievance redressal. Further such data fiduciaries will also be required to appoint a data auditor who will evaluate their compliance with the Data Protection Bill (if and once passed into law).

Shops and Establishments Legislations

Establishments are required to be registered under the provisions of local shops and establishments legislations applicable in the states where such establishments are set up. Such legislations regulate the working and employment conditions of workers employed in such shops and establishments including commercial establishments and provide for

fixation of working hours, rest intervals, overtime, holidays, leave, termination of service, maintenance of shops and establishments and other rights and obligations of the employers and employees. Shops and establishments have to be registered under the shops and establishments legislations of the respective states where they are located.

Transfer of Property Act, 1882

The Transfer of Property Act, 1882 (the “*T.P. Act*”) governs the transfer of property, including immovable property, between natural persons excluding a transfer by operation of law. The T.P. Act establishes the general principles relating to the transfer of property, including among other things, identifying the categories of property that are capable of being transferred, the persons competent to transfer property, the validity of restrictions and conditions imposed on the transfer and the creation of contingent and vested interest in the property. The T.P. Act also provides for the rights and liabilities of the vendor and purchaser in case of a transaction relating to sale of property and the lessor and lessee if the transaction involves lease of land, as the case may be.

Sale of Goods Act, 1930

The Sale of Goods Act, 1930 (the “*Sale of Goods Act*”) governs contracts relating to the sale of goods. The contracts for sale of goods are subject to the general principles of the law relating to contracts. A contract for sale may be an absolute one or based on certain conditions. The Sale of Goods Act contains provisions in relation to the essential aspects of such contracts, including the transfer of ownership of goods, delivery of goods, rights and duties of the buyer and seller, remedies for breach of contract and the conditions and warranties implied under a contract for the sale of goods.

The Registration Act, 1908

The Registration Act, 1908 (the “*Act*”) was passed to consolidate all the previous legislations which were enacted in relation to the registration of documents. This Act was promulgated to achieve the purpose of maintaining a proper regulatory record of transactional documents with a recognized officer in order to safeguard the original copies. The Act lays down two types of registration of documents, one being mandatory registration, which has been laid down under Section 17 of the Act and relates to documents such as, *inter alia* gift deed or transfer deed for an immovable property, non-testamentary instruments purporting to an interest in any immovable property, leasing or renting an immovable property. The other type of registration has been laid down under Section 18 of the Act which provides for the category of documents, registration of which is optional or discretionary and include, wills, instrument for transfer of shares, adoption deeds, etc. Failure to register a document under Section 17 of the Act can attract severe consequences, including declaration of invalidity of the transfer in question; however, no such consequence is attracted in case of Section 18 of the Act. Sections 28 and 31 of the Act provide the sub-registrars and other officers, the authority to register documents under this Act. Registration of a document, provides authenticity to a document and also acts as a conclusive proof in relation to the execution of such a document in the court of law.

The Indecent Representation of Women (Prohibition) Act, 1986 (“IRWA”)

The IRWA prohibits indecent representation of women through advertisements, publications, writings, paintings, figures or in any other manner. It states that no person shall publish or release any advertisements involving an obscene portrayal of women or agree to participate in the publication or show, in any form. In the event an offence under IRWA has been committed by a company, every person, who, at the time the offence was committed was in-charge of, and was responsible to, the company for the conduct of the business of the company, as well as the company, shall be deemed to be guilty of the offence and shall be liable to be proceeded against and punished accordingly.

Factories Act, 1948

The term 'factory', as defined under the Factories Act, means any premises which employs or has employed on any day in the previous 12 months, 10 or more workers and in which any manufacturing process is carried on with the aid of power, or any premises wherein 20 or more workmen are employed at any day during the preceding 12 months and in which any manufacturing process is carried on without the aid of power. State Governments have issued rules in respect of the prior submission of plans and their approval for the establishment of factories and registration and licensing of factories.

The Factories Act requires the 'occupier' of a factory to ensure the health, safety and welfare of all workers in the factory premises. Further, the "occupier" of a factory is also required to ensure (i) the safety and proper maintenance of the factory such that it does not pose health risks to persons in the factory premises; (ii) the safe use, handling, storage and transport of factory articles and substances; (iii) provision of adequate instruction, training and supervision to

ensure workers' health and safety; and (iv) cleanliness and safe working conditions in the factory premises. If there is a contravention of any of the provisions of the Factories Act or the rules framed thereunder, the occupier and manager of the factory may be punished with either imprisonment or fine or both.

Laws Relating to the Specific State Where Our Establishment Is Situated Maharashtra Industrial Policy, 2019

The Maharashtra Industrial Policy, 2019 (the "Industrial Policy") envisages making Maharashtra USD 1 Trillion economy in the country, by augmenting manufacturing ecosystem, complemented by ease of doing business initiatives, thereby evolving it into a preferred destination for global manufacturers and investors, resulting into largest employment creating state with balanced regional and inclusive growth, by 2025. In the Industrial Policy, the target has been to attain manufacturing sector growth rate of 12% to 13% to reach GSDP share of 25% by 2023-24; to attract investments worth INR 10 lakh crore by 2023-24 and to create employment opportunities for 40 lakh people by 2023-24.

Some of the objectives and strategies of the policy includes retaining leadership position in industrial investment by providing conducive business environment, creating land bank for industries through MIDC, promoting investments through sector specific promotion/policies with focus on identified thrust sectors, incentivizing investments in R&D and start-ups, facilitating 'Ease of Doing Business' initiatives and strengthening Maharashtra's Single Window System i.e. MAITRI - an online portal, making a single point for delivery of services, setting up of State level councils for promotion of investments and exports etc.

Shops and Commercial Establishments Legislation

The Company is governed by shops and establishments legislations, as applicable in the States of Uttar Pradesh. These regulations regulate the conditions of work and employment in shops and commercial establishments and generally prescribe obligations in respect of inter alia registration, opening and closing hours, daily and weekly working hours, holidays, leave, health, and safety measures, and wages for overtime work. These establishments of the company will be governed by the acts, rules, and regulations of the respective states.

Indian Stamp Act, 1899 ("Stamp Act")

Legislations pertaining to Stamp Duty Stamp duty in relation to certain specified categories of instruments as specified under Entry 91 of the list, is governed by the provisions of the Indian Stamp Act, 1899 ("Stamp Act") which is enacted by the Central Government. All others instruments are required to be stamped, as per the rates prescribed by the respective State Governments in the respective schedules of the respective legislations pertaining to stamp duty as applicable in the State. Stamp duty is required to be paid on all the documents that are registered and as stated above the percentage of stamp duty payable varies from one State to another. Certain State in India have enacted their own legislation in relation to stamp duty while the other State have adopted and amended the Stamp Act, as per the rates applicable in the State. On such instruments stamp duty is payable at the rates specified in Schedule I of the Stamp Act. Instruments chargeable to duty under the Stamp Act which are not duly stamped are incapable of being admitted in court as evidence of the transaction contained therein. The Stamp Act also provides for impounding of instruments which are not sufficiently stamped or not stamped at all. Unstamped and deficiently stamped instruments can be impounded by the authority and validated by payment of penalty. The amount of penalty payable on such instruments may vary from State to State.

Maharashtra State Tax on Professions, Trades, Callings and Employments Act, 1975

The professional tax slabs in India are applicable to those citizens of India who are either involved in any profession or trade. The State Government of each State is empowered with the responsibility of structuring as well as formulating the respective professional tax criteria and is also required to collect funds through professional tax. The professional taxes are charged on the incomes of individuals, profits of business or gains in vocations. The tax payable under the State Acts by any person earning a salary or wage shall be deducted by his employer from the salary or wages payable to such person before such salary or wages is paid to him, and such employer shall, irrespective of whether such deduction has been made or not when the salary and wage is paid to such persons, be liable to pay tax on behalf of such person and employer has to obtain the registration from the assessing authority in the prescribed manner.

Maharashtra Factories Rules, 1963 ("Factories Rules")

The Factories Rules were notified by State of Maharashtra within the framework of Factories Act, 1948 which is a social legislation that has been enacted for occupational safety, health, and welfare of workers at workplace. As per the

Factories Rules an application for obtaining prior permission for the site on which the factory is to be situated and for the construction or extension of a factory shall be made to the Chief Inspector of Factories which shall grant the license with terms and conditions after being satisfied that there is no objection to the same.

B. INTELLECTUAL PROPERTY LAWS

Intellectual property rights refer to the general term for intangible, intellectual, industrial property rights through patents, copyrights and trademarks and includes geographical indications, trade secrets, and confidential information. These property rights allow the holder to exercise a monopoly on the use of the item for a specified period.

The Copyright Act, 1957

The Copyright Act, 1957, along with the Copyright Rules, 2013 (“Copyright Laws”) governs copyright protection in India. The Copyright Laws protect the legal rights of the creator of an ‘original work’ by preventing others from reproducing the work in any other way. The intellectual property protected under the Copyright Laws includes literary works, dramatic works, musical works, artistic works, cinematography, and sound recordings. Even while copyright registration is not a prerequisite for acquiring or enforcing a copyright in an otherwise copyrightable work, registration under the Copyright Laws acts as prima facie evidence of the particulars entered therein and helps expedite infringement proceedings and reduce delay caused due to evidentiary considerations. The Copyright Laws prescribe a fine, imprisonment or both for violations, with enhanced penalty on second or subsequent convictions. Upon registration, the copyright protection for a work exists for a period of 60 years following, the demise of the author. Reproduction of a copyrighted work for sale or hire, issuing of copies to the public, performance, or exhibition in public, making a translation of the work, making an adaptation of the work, and making a cinematograph film of the work without consent of the owner of the copyright are all acts which expressly amount to an infringement of copyright.

The Trademarks Act, 1999 (the “Trademarks Act”)

Trademarks enjoy protection under both statutory and common law and Indian trademark law permits the registration of trademarks for both goods and services. The Trademarks Act governs the statutory protection of trademarks and the prevention of the use of fraudulent marks in India. Under the provisions of the Trademarks Act, an application for trademark registration may be made before the Trademark Registry by any person claiming to be the proprietor of a trade mark, whether individual or joint applicants, and can be made on the basis of either actual use or intention to use a trademark in the future. Once granted, a trademark registration is valid for 10 years unless cancelled, subsequent to which, it can be renewed. If not renewed, the mark lapses and the registration is required to be restored. The Trademarks Act prohibits registration of deceptively similar trademarks and provides for penalties for infringement, falsifying and falsely applying trademarks. Further, pursuant to the notification of the Trademark (Amendment) Act, 2010 simultaneous protection of trademark in India and other countries has been made available to owners of Indian and foreign trademarks. The Trademark (Amendment) Act, 2010 also seeks to simplify the law relating to transfer of ownership of trademarks by assignment or transmission and to conform Indian trademark law with international practice.

The Patents Act, 1970 (the “Patents Act”)

The Patents Act recognises both product and process patents and prescribes eligibility criteria for grant of patents, including the requirement that an invention satisfy the requirements of novelty, inventive step and industrial applicability in order for it to avail patent protection. However, the Patents Act also provides that patent protection may not be granted to certain specified types of inventions and materials even if they satisfy such criteria. Application by an Indian resident to any foreign authority in respect of an invention made outside India is prohibited without first making an application for the invention in India. Once granted, a patent remains valid for a period of twenty years from the date of filing of the patent application, subsequent to which it can be renewed. While the Patents Act prohibits patentability of a ‘computer programme’ as such, computer programmes in combination with a novel hardware are patentable. Computer programmes on their own are excluded from patent protection and are protected as a literary work under the Copyright Act, 1957. In terms of the Patent Act, the patentee holds the exclusive right to prevent third parties from the using, offering for sale, selling or importing for such purposes, the patented product or product obtained directly by a process patented in India.

The Designs Act, 2000 (the “Designs Act”)

The Designs Act prescribes for the registration of designs. The Designs Act specifically lays down the essentials of a design to be registered and inter alia, provides for application for registration of designs, copyright in registered designs, etc. A 'Design' means only the features of shape, configuration, pattern, ornament or composition of lines or s or combination thereof applied to any article whether two dimensional or three dimensional or in both forms, by any industrial process or means, whether manual, mechanical or chemical, separate or combined, which in the finished article appeal to and are judged solely by the eye, but does not include any mode or principle or construction or anything which is in substance a mere mechanical device, and expressly excludes works accorded other kinds of protection like property marks, trademarks and copyrights. Any person claiming to be the proprietor of a new or original design may apply for registration of the same before the Controller-General of Patents, Designs and Trade Marks. On registration, the proprietor of the design attains a copyright over the same. The duration of the registration of a design in India is initially ten years from the date of registration. No person may sell, apply for the purpose of sale or import for the purpose of sale any registered design, or fraudulent or obvious imitation thereof.

Municipality Laws

Pursuant to the Constitution (Seventy-Fourth Amendment) Act, 1992, the respective state legislatures in India have power to endow the municipalities with power to implement schemes and perform functions in relation to matters listed in the Twelfth Schedule to the Constitution of India. The respective States of India have enacted laws empowering the municipalities to issue trade license for operating stores and implementation of regulations relating to such license along with prescribing penalties for non-compliance.

Approvals from Local Authorities

Setting up of a Factory or Manufacturing/Housing unit/Establishments entails the requisite Planning approvals to be obtained from the relevant Local Panchayat(s) outside the city limits and appropriate Metropolitan Development Authority within the city limits. Consents from the state Pollution Control Board(s), the relevant state Electricity Board(s), the State Excise Authorities, Sales Tax, are required to be obtained before commencing the building of a factory or the start of manufacturing operations.

C. TAX LAWS

In addition to the aforementioned material legislations which are applicable to our Company, some of the tax legislations that may be applicable to the operations of our Company include:

- Income-tax Act 1961, the Income-tax Rules, 1962, as amended by the Finance Act in respective years;
- Central Goods and Services Tax Act, 2017, the Central Goods and Services Tax Rules, 2017 and various state-wise legislations made thereunder;
- The Integrated Goods and Services Tax Act, 2017 and rules thereof;
- Professional tax-related state-wise legislations;
- Indian Stamp Act, 1899 and various state-wise legislations made thereunder; and

D. ENVIRONMENTAL LAWS

The Environment (Protection) Act, 1986 ("EPA")

The EPA has been enacted for the protection and improvement of the environment. It stipulates that no person carrying on any industry, operation or process shall discharge or emit or permit the discharge or emission of any environmental pollutant in excess of such standards as may be prescribed. Further, no person shall handle or cause to be handled any hazardous substance except in accordance with such procedure and after complying with such safeguards as may be prescribed. EPA empowers the Central Government to take all measures necessary to protect and improve the environment such as laying down standards for emission or discharge of pollutants, providing for restrictions regarding areas where industries may operate and generally to curb environmental pollution.

E-Waste Management Rules, 2016 (the "E-Waste Rules")

The E-Waste Rules apply to every manufacturer, producer, consumer, bulk consumer, collection centres, dealers, e-retailer, refurbisher, dismantler and recycler involved in manufacture, sale, transfer, purchase, collection, storage and processing of e-waste or electrical and electronic equipment as classified under the E-Waste Rules, including their

components, consumables, parts and spares which make the product operations. The E-Waste Rules mandate that a manufacturer must obtain an authorisation from the state pollution control board and also submit annual returns to the same Authority. Producers of such e-waste also have extensive responsibilities and obligations and may come under the scrutiny of either the central pollution control board or the state pollution control board. The manufacturer, producer, importer, transporter, refurbisher, dismantler and recycler shall be liable for all damages caused to the environment or a third party due to improper handling and management of the e-waste and may have to pay financial penalties as levied for any violation of the provisions under these rules by the state pollution control board with the prior approval of the central pollution control board.

Water (Prevention and Control of Pollution) Act, 1974 (“Water Act”)

The Water Act aims to prevent and control water pollution and to maintain or restore wholesomeness of water. The Water Act provides for one central pollution control board, as well as state pollution control boards, to be formed to implement its provisions, including enforcement of standards for factories discharging pollutants into water bodies. Any person intending to establish any industry, operation or process or any treatment and disposal system likely to discharge sewage or other pollution into a water body, is required to obtain the consent of the relevant state pollution control board by making an application.

Air (Prevention and Control of Pollution) Act, 1981 (“Air Act”)

The Air Act aims to prevent, control and abate air pollution, and stipulates that no person shall, without prior consent of the relevant state pollution control board, establish or operate any industrial plant which emits air pollutants in an air pollution control area. Such person also cannot discharge or cause or permit to be discharged the emission of any air pollutant in excess of the standards laid down by the State Boards. The central pollution control board and the state pollution control boards constituted under the Water Act perform similar functions under the Air Act as well. Pursuant to the provisions of the Air Act, any person establishing or operating any industrial plant within an air pollution control area, must obtain the consent of the relevant state pollution control board prior to establishing or operating such industrial plant.

Hazardous and Other Wastes (Management and Transboundary Movement) Rules, 2016 (“Hazardous Waste Rules”) as amended by the Hazardous and Other Wastes (Management and Transboundary Movement) Amendment Rules, 2022

The Hazardous Waste Rules regulate the management, treatment, storage and disposal of hazardous waste by imposing an obligation on every occupier and operator of a facility generating hazardous waste to dispose of such waste without harming the environment. The term “hazardous waste” has been defined in the Hazardous Waste Rules and any person who has, control over the affairs of the factory or the premises or any person in possession of the hazardous waste has been defined as an “occupier”. Every occupier and operator of a facility generating hazardous waste must obtain authorization from the relevant state pollution control board. Further, the occupier, importer or exporter is liable for damages caused to the environment resulting from the improper handling and disposal of hazardous waste and must pay any financial penalty that may be levied by the respective state pollution control board.

E. FOREIGN TRADE REGULATIONS

The Foreign Trade (Regulation and Development) Act, 1992 and the rules framed thereunder (“FTA”)

The FTA is the main legislation concerning foreign trade in India. The FTA, read along with Foreign Trade (Regulation) Rules, 1993, provides for the development and regulation of foreign trade by facilitating imports into, and augmenting exports from, India and for matters connected therewith or incidental thereto. As per the provisions of the FTA, the Government:- (i) may make provisions for facilitating and controlling foreign trade; (ii) may prohibit, restrict and regulate exports and imports, in all or specified cases as well as subject them to exemptions; (iii) is authorised to formulate and announce an export and import policy and also amend the same from time to time, by notification in the Official Gazette; (iv) is also authorised to appoint a 'Director General of Foreign Trade' for the purpose of the FTA, including formulation and implementation of the Export-Import (“EXIM”) Policy.

The FTA prohibits anybody from undertaking any import or export except under an Importer-Exporter Code number (“IEC”) granted by the Director General of Foreign Trade pursuant to Section 7 of the FTA. Hence, every entity in India engaged in any activity involving import/export is required to obtain an IEC unless specifically exempted from doing so. Failure to mention IEC number attracts a penalty of not less than ₹10,000 and not more than five times the

value of the goods or services or technology in respect of which any contravention is made or is attempted to be made, whichever is made. The IEC shall be valid until it is cancelled by the issuing authority

Foreign Investment Laws

Foreign investment in India is governed by the provisions of the Foreign Exchange Management (Non-debt Instruments) Rules, 2019 (“FEMA Rules”) along with the Consolidated FDI Policy issued by the DPIIT, from time to time. Further, the RBI has enacted the Foreign Exchange Management (Mode of Payment and Reporting of Non-Debt Instruments) Regulations, 2019 which regulate the mode of payment and reporting requirements for investments in India by a person resident outside India. Under the FEMA Rules and Consolidated FDI Policy (effective October 15, 2020), 100% foreign direct investment is permitted in single brand product retail trading sector, under the automatic route, subject to certain conditions specified thereunder. Further, in the event of foreign direct investment beyond 51%, the investee entity is also required to comply with certain local sourcing norms as specified in the FEMA Rules and the Consolidated FDI Policy. In terms of the FEMA Rules, the total holding by each FPI, or an investor group shall be below 10% of the total paid-up equity share capital of our Company on a fully diluted basis and the total holdings of all FPIs put together with effect from April 1, 2020, will be upto the sectoral cap applicable to the sector in which our Company operates (i.e., upto 100%), unless reduced by way of passing a special resolution.

F. EMPLOYMENT RELATED LAWS

In order to rationalize and reform labour laws in India, the Government of India has notified four labour codes which are yet to come into force as on the date of this Draft Prospectus, namely, (i) the Code on Wages, 2019 which will repeal the Payment of Bonus Act, 1965, Minimum Wages Act, 1948, Equal Remuneration Act, 1976 and the Payment of Wages Act, 1936, (ii) the Industrial Relations Code, 2020 which will repeal the Trade Unions Act, 1926, Industrial Employment (Standing Orders) Act, 1946 and Industrial Disputes Act, 1947, (iii) the Code on Social Security, 2020 which will repeal certain enactments including the Employee's Compensation Act, 1923, the Employees' State Insurance Act, 1948, the Employees' Provident Funds and Miscellaneous Provisions Act, 1952, Maternity Benefit Act, 1961, Employment Exchanges (Compulsory Notification of Vacancies) Act, 1959 and the Payment of Gratuity Act, 1972 and (iv) the Occupational Safety, Health and Working Conditions Code, 2020 which will repeal certain enactments including the Factories Act, 1948, Motor Transport Workers Act, 1961 and the Contract Labour (Regulation and Abolition) Act, 1970.

Certain portions of the Code on Wages, 2019 and Code on Social Security, 2020, have come into force upon notification by the Ministry of Labour and Employment. The remaining provisions of these codes shall become effective as and when notified by the Government of India. A brief summary of the aforementioned laws have been provided below:

The Code on Wages, 2019

The Code on Wages, 2019 received the assent of the President of India on August 8, 2019 and proposes to subsume four existing laws namely, the Payment of Wages Act, 1936, the Minimum Wages Act, 1948, the Payment of Bonus Act, 1965 and the Equal Remuneration Act, 1976. The Central Government has notified certain provisions of this code mainly in relation to the constitution of the advisory board.

The Occupational Safety, Health and Working Conditions Code, 2020

The Occupational Safety, Health and Working Conditions Code, 2020 received the assent of the President of India on September 28, 2020 and proposes to subsume certain existing legislations, including the Factories Act, 1948, the Contract Labour (Regulation and Abolition) Act, 1970, the Inter-State Migrant Workmen (Regulation of Employment and Conditions of Service) Act, 1979 and the Building and Other Construction Workers (Regulation of Employment and Conditions of Service) Act, 1996. The provisions of this code will be brought into force on a date to be notified by the Central Government.

The Industrial Relations Code, 2020

The Industrial Relations Code, 2020 received the assent of the President of India on September 28, 2020 and it proposes to subsume three existing legislations, namely, the Industrial Disputes Act, 1947, the Trade Unions Act, 1926 and the Industrial Employment (Standing Orders) Act, 1946. The provisions of this code will be brought into force on a date to be notified by the Central Government.

The Code on Social Security, 2020

The Code on Social Security, 2020 received the assent of the President of India on September 28, 2020 and it proposes to subsume certain existing legislations including the Employee's Compensation Act, 1923, the Employees' State Insurance Act, 1948, the Employees' Provident Funds and Miscellaneous Provisions Act, 1952, the Maternity Benefit Act, 1961, the Payment of Gratuity Act, 1972, the Building and Other Construction Workers' Welfare Cess Act, 1996 and the Unorganised Workers' Social Security Act, 2008. The Central Government has notified certain provisions of this code.

Employees State Insurance Act, 1948, as amended (the "ESIC Act")

The ESI Act, provides for certain benefits to employees in case of sickness, maternity and employment injury. All employees in establishments covered by the ESI Act are required to be insured, with an obligation imposed on the employer to make certain contributions in relation thereto. In addition, the employer is also required to register itself under the ESI Act and maintain prescribed records and registers. Employees (Provident Fund and Miscellaneous Provisions) Act, 1952, as amended (the "EPF Act") The EPF Act applies to factories employing over 20 employees and such other establishments and industrial undertakings as notified by the GoI from time to time. It requires all such establishments to be registered with the state provident fund commissioner and requires such employers and their employees to contribute in equal proportion to the employees' provident fund the prescribed percentage of basic wages and dearness and other allowances payable to employees. The EPF Act also requires the employer to maintain registers and submit a monthly return to the State provident fund commissioner.

Maharashtra Labour Welfare Fund Act, 1953

The Government of Maharashtra has enacted the Labour Welfare Fund Act for providing welfare benefits to the labourers employed in establishments/factories situated in Maharashtra. It extends to the whole state of Maharashtra. The Maharashtra Labour Fund Act, 1953 is read with Maharashtra Labour Welfare Fund Rules, 1953. The rates of contribution vary according to the category of the labourers, as it depends on the wages earned by the labourers. The Maharashtra Labour Fund is applicable to all the companies in the state that has 5 or more persons employed. The state government constitute the labour Welfare Fund; the fund consists of the following: (a) Fines from employees; (b) Unpaid Accumulations; (c) Penal interest; (d) Voluntary donations; (e) Contributions made by employer-employee; (f) Any interest accrued on unpaid accumulations or fines realised from employees; and (g) Loan, grant in subsidy. Moreover, the employer is required to submit a statement which states all the particulars related to the contribution made.

The Sexual Harassment of Women at Workplace (Prevention, Prohibition and Redressal) Act, 2013

The Sexual Harassment of Women at Workplace (Prevention, Prohibition and Redressal) Act, 2013 ("SHWW Act") provides for the protection of women at workplace and prevention of sexual harassment at workplace. The SHWW Act also provides for a redressal mechanism to manage complaints in this regard. Sexual harassment includes one or more of the following acts or behaviour namely, physical contact and advances or a demand or request for sexual favours or making sexually coloured remarks, showing pornography or any other unwelcome physical, verbal or non-verbal conduct of sexual nature. The SHWW Act makes it mandatory for every employer of a workplace to constitute an Internal Complaints Committee, which shall always be presided upon by a woman.

G. GENERAL CORPORATE AND OTHER ALLIED LAWS

Apart from the above list of laws which is inclusive in nature and not exhaustive – general laws like the Indian Contract Act, 1872, Specific Relief Act, 1963, Negotiable Instruments Act, 1881, Consumer Protection Act, 1986, Anti-Trust law such as Competition Act, 2002 and corporate Acts namely Companies Act, 2013 are also applicable to the Company.

HISTORY AND CERTAIN CORPORATE MATTERS

Our Company was incorporated as Flash Forge Fluid Control Private Limited on February 16, 2012 under the Companies Act, 1956 with the Registrar of Companies, Mumbai, Maharashtra bearing Registration number 227023. The name of our company was changed to CFF Fluid Control Private Limited vide Special resolution dated September 21, 2012. The fresh certificate of incorporation consequent of name change was issued on October 19, 2012 by the Registrar of Companies, Mumbai, Maharashtra. Further the status of the Company was changed to Public limited and the name of our Company was changed to CFF Fluid Control Limited vide Special Resolution dated September 05, 2022. The fresh certificate of incorporation consequent to conversion was issued on September 15, 2022 by the Registrar of Companies, Mumbai, Maharashtra. The Corporate Identification Number of our Company is U28990MH2012PLC227023.

Corporate Profile of our Company

For information on our Company's business profile, activities, services, managerial competence, and customers, see "Our Business" and "Our Management" on page 89 and 120 respectively of this Draft Prospectus.

Change in registered office of our Company

Date of Change	Changed From	Change to	Reason for change
March 08, 2016	71-73, Udyog Bhavan, Sonavala Road, Goregaon East, Mumbai - 400063	Plot No. 01, Survey No. 96, Kumbhivli - Madap - Khopoli, Khalapur, Raigad - 410203	Administrative Reasons

OVERVIEW

Our company is primarily in the business of manufacturing and servicing of shipboard machinery, critical component systems and test facilities for submarines & surface ships for the Indian Defence PSU Shipyard.

For further information, please refer the chapter "Our business" on page no. 89 of this Draft Prospectus.

MAIN OBJECTS OF OUR COMPANY

The main objects of our Company as set forth in the Memorandum of Association of our Company is to carry on in India for navy and military applications, the business of manufacturers, dealers, agents, factors, importers, exporters, distributors, dealers, stockists, traders, agents, consignors, merchants and financiers of all kinds of valves made with either metallic or non-metallic materials by any process of casting, forging, machining, servicing, assembly or by any other process as deemed fit.

The main objects and objects incidental and ancillary to the attainment of the main objects, as contained in the Memorandum of Association, enable our Company to carry on its existing business.

The main objects as contained in the MoA enable our Company to carry on the business presently being carried out and the activities proposed to be undertaken pursuant to the objects of this Issue.

Amendments to the Memorandum of Association

Sr. No.	Date of Shareholder's Resolution	Nature of Amendment
1.	September 21, 2012	The name of our company was changed from Flash Fluid Control Private Limited to CFF Fluid Control Private Limited consequent to which a Fresh Certificate of Incorporation dated October 19, 2012 was issued by the Registrar of Companies, Mumbai.
2.	September 21, 2012	The Authorized Share Capital shares of ₹ 100,000 (One Lakhs) divided into 10,000 (Ten Thousand) Equity Shares of ₹ 10 each was increased to ₹ 1,00,00,000 (One Crore) divided into 10,00,000 (Ten Lakhs) Equity Shares of Rs. 10 each.
3.	July 07, 2022	The Authorized Share Capital shares of ₹ 1,00,00,000 (One Crore) divided into 10,00,000 (Ten Lakhs) Equity Shares of Rs. 10 each was increased to ₹ 20,00,00,000 (Twenty Crore) divided into 200,00,000 (Two Crore) Equity Shares of Rs. 10 each.
4.	September 05, 2022	Alignment of the Objects clause of Memorandum of Association in line with

Sr. No.	Date of Shareholder's Resolution	Nature of Amendment
		Companies Act, 2013.
5.	September 05, 2022	The name of our company was changed from 'CFF Fluid Control Private Limited' to 'CFF Fluid Control Limited' upon conversion from Private Company to Public Company consequent to which a Fresh Certificate of Incorporation dated September 15, 2022 was issued by the Registrar of Companies, Mumbai.
6.	November 25, 2022	The Authorized Share Capital shares of ₹ 20,00,00,000 (Twenty Crore) divided into 200,00,000 (Two Crore) Equity Shares of ₹ 10 each was increased to ₹ 21,00,00,000 (Twenty One Crore) divided into 210,00,000 (Two Crore Ten Lakhs) Equity Shares of ₹ 10 each.

Major events and milestones

The table below sets forth some of the key events, milestones in our history since its incorporation.

Year	Major Events / Milestone / Achievements
2012	▪ Incorporation of our Company as Flash Forge Fluid Control Private Limited
2012	▪ Name of the Company was changed to CFF Fluid Control Private Limited vide special resolution passed at general meeting dated September 21, 2012.
2015	▪ Company received government order from Naval Group..
2015	▪ Company acquired service from Coyard SAS France for design, manufacture and supply of Mechanical Components for the Scorpene submarine program
2018	▪ Turnover of our Company crossed ₹ 20 crore mark
2019	▪ Turnover of our Company crossed ₹ 35 crore mark
2020	▪ Participant SIDM Champion Awards 2020 under category of Creation of Niche Technological capability for Design, Manufacturing or Testing. –Sub Category : SSI/Start -up
2022	▪ Turnover of our Company crossed ₹ 45 crore mark.
2022	▪ Company converted from Private Limited Company to Public Limited Company vide special resolution passed at General Meeting dated September 05, 2022.
2022	▪ CFF has established longstanding strategic partnerships with foreign Manufacturers. The partnerships are carefully chosen to bring technology which is not available in India and is the need for the Indian Defence Industry. Our key tie-up are with M/s Nereides of France
2023	▪ The Company has offered its Equity Shares through an IPO vide Prospectus dated May 23, 2023 and the Equity Shares of our Company were listed on the BSE SME.
2023	▪ Turnover of our Company crossed ₹ 70 crore mark
2024	▪ Turnover of our Company crossed ₹ 100 crore mark

Key awards, accreditations or recognitions

Our Company has received the following awards, accreditations and recognitions:

Year	Events
2023	ISO 9001:2015 Certificate for Design, Manufacture, Marketing & Sales of Marine & Industrial Valves

SIGNIFICANT FINANCIAL OR STRATEGIC PARTNERSHIPS

Our Company has not entered into any significant financial or strategic partnerships except as entered in its normal course of business.

COLLABORATION

As on the date of this Draft Prospectus, our Company has not entered into any Collaboration except as disclosed in the "Our Business" on page no. 89 of this Draft Prospectus.

DEFAULTS OR RESCHEDULING OF BORROWINGS WITH FINANCIAL INSTITUTIONS/ BANKS

There are no defaults or rescheduling of borrowings with financial institutions/ banks, conversion of loans into Equity in relation to our Company.

TIME AND COST OVERRUN

Our Company has not experienced any significant time and cost overrun in setting up projects.

CHANGES IN THE ACTIVITIES OF OUR COMPANY DURING THE LAST FIVE YEARS

There has been no change in the activities of our Company during the last five years which may have had a material effect on the profit/loss account of our Company including discontinuance of line of business, loss of agencies or markets and similar factors.

DETAILS REGARDING ACQUISITION OF BUSINESS/UNDERTAKINGS, MERGERS, AMALGAMATION, REVALUATION OF ASSETS

Our Company has not made any material acquisitions or divestments of any business or undertaking, and has not undertaken any mergers, amalgamation or revaluation of assets in the last ten years.

Our Company has neither revalued its assets nor has issued any Equity Shares (including bonus Shares) by capitalizing any revaluation reserves since its incorporation.

NUMBER OF SHAREHOLDERS

As on January 10, 2025, the total number of shareholders of our Company is 3,738.

INJUNCTION OR RESTRAINING ORDER

As on the date of this Draft Prospectus, our Company is not operating under any injunction or restraining order.

OUR HOLDING COMPANY

As on the date of this Draft Prospectus, our Company does not have any Holding Company.

OUR SUBSIDIARIES

As on the date of this Draft Prospectus our Company does not have any subsidiary.

JOINT VENTURES

As on the date of this Draft Prospectus, there are no joint ventures of our Company.

OUR ASSOCIATES

As on the date of this Draft Prospectus our Company does not have any associate companies.

THE AMOUNT OF ACCUMULATED PROFIT / (LOSSES) NOT ACCOUNTED FOR BY OUR COMPANY

There is no accumulated profit / (losses) not accounted for by our Company.

SHAREHOLDERS' AGREEMENT

Our Company has not entered into any Shareholders Agreement as on the date of this Draft Prospectus.

OTHER AGREEMENTS

Except the contracts / agreements entered in the ordinary course of the business carried on or intended to be carried on by our Company, we have not entered into any other agreement / contract as on the date of this Draft Prospectus.

AGREEMENTS WITH KEY MANAGERIAL PERSONNEL OR A DIRECTOR OR PROMOTERS OR ANY OTHER EMPLOYEE OF THE COMPANY

There are no agreements entered into by key managerial personnel or a Director or Promoters or any other employee of our Company, either by themselves or on behalf of any other person, with any shareholder or any other third party with regard to compensation or profit sharing in connection with dealings in the securities of our Company.

AGREEMENTS WITH STRATEGIC PARTNERS, JOINT VENTURE PARTNERS AND/OR FINANCIAL PARTNERS AND OTHER AGREEMENTS

As on the date of this Draft Prospectus, our Company has not entered into any other subsisting material agreements including with strategic partners, joint venture partners, and/or financial partners other than in the ordinary course of business of our Company.

Our Company, our Directors, our Promoters, the members of the Promoter Group and/or, the Shareholders are not party to any agreements, including any deed of assignment, acquisition agreement, shareholders agreement, inter-se agreement/arrangement or agreements of like nature, with respect to securities of our Company and which provide any special rights to any Shareholders / Stakeholders. We confirm there are no other clauses or covenants which our Company, our Directors, our Promoters, the members of the Promoter Group or the Shareholder are a party to, in relation to securities of our Company, which are material and adverse or pre-judicial to the interest of the minority / public shareholders. Further any special rights to any shareholders/ stakeholders; post listing shall be subject to approval of the Shareholders by way of a special resolution, in a general meeting of the Company held post listing of the Equity Shares. Further as on the date of this Draft Prospectus, there are no subsisting shareholders agreement among our shareholders vis-à-vis our Company.

GUARANTEES GIVEN BY PROMOTERS

As on the date of this Draft Prospectus, no guarantee has been issued by Promoters for our Company except as disclosed in the “*Financial Indebtedness*” on page no. 170 of this Draft Prospectus.

COLLABORATION

As on the date of this Draft Prospectus, our Company has not entered into any Collaboration except as disclosed in the “*Our Business*” on page no. 89 of this Draft Prospectus

OUR MANAGEMENT

Our Board of Directors

As on the date of this Draft Prospectus, our Board consists of Four (4) Directors including one (1) Managing Director, one (1) Non - Executive Director and two (2) Non - Executive Independent Director. Further, we have One (1) Women Director on our Board.

Set forth below, are details regarding our Board as on the date of this Draft Prospectus:

Sr. No.	Name, Designation, Address, Date of Birth, Occupation, Term and DIN	Nationality	Age (in years)	Other Directorships
1.	<p>Sunil Menon</p> <p>Designation: Managing Director</p> <p>Date of Birth: July 15, 1967</p> <p>Address: Flat No 501, A Wing Adonia, Hiranandani Garden, Powai, Mumbai Maharashtra 400076.</p> <p>Date of appointment: Upon Incorporation</p> <p>Date of Appointment at Current Designation: September 30, 2022</p> <p>Current Term: Five years from September 30, 2022 and subject to retire by rotation.</p> <p>Occupation: Business</p> <p>DIN: 00409485</p>	Indian	57	<ol style="list-style-type: none"> 1. Aay Aar Consultancy Services Private Limited 2. Airotech Profiles (India) Private Limited 3. Autostem Technologies India Private Limited 4. Century Environmental Systems Private Limited 5. FF Flowline Private Limited 6. Flash Forge Private Limited 7. Navigating Sales Private Limited 8. S2 Engineering Services Private Limited
2.	<p>Gautam Makker</p> <p>Designation: Chairman and Non-Executive Director</p> <p>Date of Birth: September 24, 1969</p> <p>Address: 805-806, Prathima Estate, Paradise Isle, Maharanipeta, Visakhapatnam (Urban), Visakhapatnam, Andhra Pradesh -400067</p> <p>Date of appointment: Upon Incorporation</p> <p>Date of Appointment at Current Designation: September 30, 2022</p> <p>Current Term: Liable to retire by rotation</p> <p>Occupation: Business</p> <p>DIN: 00354956</p>	Indian	55	<ol style="list-style-type: none"> 1. Airotech Profiles (India) Private Limited 2. Autostem Technologies India Private Limited 3. Century Environmental Systems Private Limited 4. Diplok Advisory Private Limited 5. FF Flowline Private Limited 6. Flash Forge Private Limited
3.	<p>Priyanka Moondra Rathi</p> <p>Designation: Non-Executive Independent Director</p>	Indian	31	<ol style="list-style-type: none"> 1. Arrowhead Separation Engineering Limited 2. Capstar Finance Private Limited 3. Pavna Industries Limited

Sr. No.	Name, Designation, Address, Date of Birth, Occupation, Term and DIN	Nationality	Age (in years)	Other Directorships
	<p>Date of Birth: January 13, 1993</p> <p>Address: Plot No. 16/2 B, Bhatti Ki Bavri, Chopasni Housing Board, Jodhpur, Rajasthan 342008.</p> <p>Date of Appointment at Current Designation: September 02, 2022</p> <p>Term: Appointed for 5 Years from September 02, 2022</p> <p>Occupation: Professional</p> <p>DIN: 09485101</p>			<p>4. Rex Sealing and Packing Industries Limited</p> <p>5. Shreeshay Engineers Limited</p> <p>6. UMA Polymers Limited</p>
4.	<p>Rajnish Prakash</p> <p>Designation: Non-Executive Independent Director</p> <p>Date of Birth: July 04, 1953</p> <p>Address: C/502, Haware Tiara Building, Plot No. 184, Sector 13, Kharghar, Navi Mumbai, Raigarh, Maharastra -410210.</p> <p>Date of Appointment at Current Designation: September 30, 2022</p> <p>Term: Appointed for 5 Years from September 30, 2022</p> <p>Occupation: Professional</p> <p>DIN:08595423</p>	Indian	71	NIL

For further details on their qualification, experience etc., please see their respective biographies under the heading “Brief Biographies” below.

BRIEF BIOGRAPHIES OF OUR DIRECTORS

Sunil Menon, aged 57 years is the founding Promoter of our company and was appointed on the Board of our Company since incorporation. He was re-designated as the Managing Director w.e.f. September 30, 2022. He has completed his Diploma in Hotel Management, Catering and Nutrition from Board of Technical Education Delhi. He has more than 30 years’ experience in Businesses like defence and in engineering company. He has taken the company from being a small components manufacturer to a strong company whose product and services portfolio includes Turnkey Projects, Integrating various platform systems. The company today has a strong product portfolio and a loyal customer base and he has contributed substantially in growth of business of company and has been a guiding force behind the growth and business strategy of our Company.

Gautam Makker, aged 55 years is the founding Promoter of our company and was appointed on the Board of our Company since incorporation. He was re-designation as Chairmen and Non-Executive Director w.e.f. September 30, 2022. He has completed his Bachelor of Electrical Engineering from Poona University in the year 1991. He has more than 25 years of experience in the fields of sourcing and providing solutions to defence, power and marine industry. As a Non-Executive Director of the Company, he is responsible for providing his expertise for growth and expansion of our Company.

Priyanka Moondra Rathi, aged 31 years is a Non-Executive Independent Director of our Company. She was appointed on the Board of our Company w.e.f. September 02, 2022. She has completed Bachelors of Commerce degree from Jai Narayan Vyas University in the year 2013 and completed Diploma in MBA in Finance from International

Business Management Institute, Berlin, Germany in the year 2015. She is also a member of Institute of Company secretaries of India since 2017 and is currently pursuing Certified Public Accountants course. Currently she is working with Transmissions International India Private Limited Rajasthan and is partner in Priav Eduserve & Consultancy LLP. She has an experience of more than 5 years including internship in the field of Secretarial, Compliances and Legal work.

Rajnish Prakash, aged 71 years is a Non-Executive Independent Director of our Company. He was appointed on the Board of our Company w.e.f. September 30, 2022. He has completed Bachelor's Degree in Chemical Engineering from University of Roorkee (Presently IIT Roorkee) in the year 1974 and also obtained PG Diploma in Chemical Engineering (Reaction Engg.) from Indian Institute of Technology, Delhi in the year 1975. He was associated with Nuclear Power Corporation of India Limited in capacity of Independent Director. He has worked in various government departments and held various posts like Chairman & Chief Executive, Heavy Water Board, Department of Atomic Energy, Chairman Atomic Energy Education Society during his entire career. He received INS Homi Bhabha Life time Achievement Award- 2014 from Indian Nuclear Society & Green tech foundation and Outstanding Engineer award from Institute of Engineer.

Confirmations

1. None of our Directors of our Company have held or currently hold directorship in any listed company whose shares have been or were suspended from being traded on any of the Stock Exchange in the five (05) years preceding the date of filing of this Offer Document with the Stock Exchange, during the term of his/her directorship in such company.
2. Further, none of our Directors of our Company are or were associated in the capacity of a director with any listed company which has been delisted from any Stock Exchange(s) at any time in the past.
3. Our Company, Promoters, members of Promoter Group and Directors are not prohibited from accessing the capital markets or have not been debarred from buying, selling or dealing in securities under any order or direction passed by SEBI or any securities market regulator in any other jurisdiction or any other authority/court. None of the companies with which our Promoters or Directors are or were associated as promoter, directors or persons in control have been debarred from accessing capital markets under any order or direction passed by SEBI or any other authorities. Neither our Company nor our directors or Promoters have been declared as a 'wilful defaulter' or a 'fraudulent borrower', as defined under the SEBI ICDR Regulations. Our Promoters or Directors have not been declared as Fugitive Economic Offenders.
4. Our Company has not entered into any service contracts with our Directors which provide for benefits upon the termination of their employment.
5. No nominee directors have been appointed on the Board of Directors of the Company on behalf of any shareholders or any other person.

Relationship between our Directors and any of our Directors and our Key Managerial Personnel and Senior Management Personnel

Except Sunil Menon who is the brother in laws of Gautam Makker, none of the Directors and Key Managerial Personnel and Senior Management Personnel are related to each other as per Section 2 (77) of the Companies Act, 2013.

Arrangements and Understanding with Major Shareholders

None of our Key Managerial Personnel, Senior Management or Directors have been appointed pursuant to any arrangement or understanding with our major shareholders, customers, suppliers or others pursuant to which any of the directors was selected as a director or member of senior management.

Payment or Benefit to officers of our Company

Except as stated otherwise in this Draft Prospectus and any statutory payments made by our Company, no non-salary amount or benefit has been paid, in two preceding years, or given or is intended to be paid or given to any of our Company's officers except remuneration of services rendered as Directors, officers or employees of our Company.

Service Contracts

The Company has not entered into any service contracts with its Directors and Key Managerial Personnel providing for benefits upon termination of employment.

DETAILS OF BORROWING POWERS

Pursuant to a special resolution passed at an Annual General Meeting of our Company held at a shorter notice on September 30, 2022 and pursuant to provisions of Section 180(1) (c) and other applicable provisions, if any, of the Companies Act, 2013 and rules made thereunder, the Board of Directors of the Company be and are hereby authorized to borrow monies from time to time, any sum or sums of money on such security and on such terms and conditions as the Board may deem fit, notwithstanding that the money to be borrowed together with the money already borrowed by our Company may exceed in the aggregate, its paid up capital and free reserves and security premium (apart from temporary loans obtained / to be obtained from bankers in the ordinary course of business), provided that the outstanding principal amount of such borrowing at any point of time shall not exceed in the aggregate of ₹ 500 crores.

REMUNERATION/COMPENSATION/COMMISSION PAID TO EXECUTIVE DIRECTORS

The compensation package payable to the Executive Directors from the date of appointment as resolved in the Annual General Meeting held on September 30, 2022 is stated hereunder:

Sr. No.	Name of Director	Designation	Maximum limit of Remuneration/Compensation (Inclusive of all perquisites)
1.	Sunil Menon	Managing Director	₹ 150.00 Lakhs

Gross Remuneration / Commission paid to our Directors for F.Y. 2023-24 is as follows:

Sr. No.	Name of Director	Remuneration paid (₹ in lakhs)
1.	Sunil Menon	84.00

PAYMENT OR BENEFIT TO NON - EXECUTIVE DIRECTORS AND OF OUR COMPANY

Pursuant to the resolution passed by the Board of Directors of our Company at their meeting held on November 04, 2022, our Non-Executive Directors are entitled to receive a sitting fee of ₹ 5,000 for attending Board meeting or committee meeting thereof.

SITTING FEES PAID TO NON – EXECUTIVE DIRECTORS BY OUR COMPANY

For F.Y. 2023-24, the Non-Executive Directors have been paid sitting fees as follows:

Sr. No.	Name of Director	Sitting Fees paid (₹ in lakhs)
1	Gautam Makker	0.60
2	Priyanka Moondra Rathi	0.60
3	Rajnish Prakash	0.60

SHAREHOLDING OF OUR DIRECTORS IN THE COMPANY

Our Articles of Association do not require our Directors to hold any qualification shares. The details of the shareholding of our Directors as on the date of this Draft Prospectus are as follows:

Sr. No.	Name of the Shareholder	No. of Shares	Percentage of Pre-Issue Share Capital (%)
1.	Sunil Menon	71,38,260	36.66%
2.	Gautam Makker	43,56,340	22.37%
	Total	1,14,94,600	59.03%

INTEREST OF DIRECTORS

All of our Directors may be deemed to be interested to the extent of fees payable to them for attending meetings of the Board or committee thereof as well as to the extent of other remuneration and reimbursement of expenses payable to

them under our Articles of Association, and to the extent of remuneration paid to them for services rendered as an officer or employee of our Company.

Our Directors may also be regarded as interested in the Equity Shares, if any, held by them or allotted to the companies in which they are interested as Directors, Members, and Promoter, pursuant to this Issue. All of our Directors may also be deemed to be interested to the extent of any dividend payable to them and other distributions in respect of the said Equity Shares.

INTEREST IN THE PROPERTY OF OUR COMPANY

Except as stated in the heading titled “Properties” under the chapter titled “*Our Business*”, beginning on page no. 89 of this Draft Prospectus, none of our Directors have interest in any property acquired or proposed to be acquired of our Company or by our Company.

INTEREST IN PROMOTION OF THE COMPANY

Except, as stated in the chapter titled “*Our Promoter and Promoter Group*” beginning from page no 133 none of our Directors are interested in the promotion of our company as on the date of this Draft Prospectus.

INTEREST AS MEMBER OF A COMPANY OR FIRM

Except as stated in this chapter titled “*Our Management*”, the section titled “*Related Party Transaction – Annexure V- Note no. 26 of Restated Financial Statements*” and the chapter “*Our Business*” on page nos 120, 140 and 89 of this Draft Prospectus respectively, our Directors do not have any other interest in our business.

CHANGES IN OUR BOARD OF DIRECTORS DURING THE LAST THREE YEARS

Name of Director	Date of Appointment/ Change	Reason for change
Rajnish Prakash	September 30, 2022	Appointment of Non- Executive Independent Director
Gautam Makker	September 30, 2022	Re-designated as Non-Executive Director
Sunil Menon	September 30, 2022	Re-designated as Managing Director
Priyanka Moondra Rathi	September 02, 2022	Appointment of Non- Executive Independent Director

Corporate Governance

In terms of Chapter IX of the SEBI (ICDR) Regulations, 2018 as amended from time to time, as on date of this Draft Prospectus, the requirement specified in regulations 17, 18, 19, 20, 21, 22, 23, 24, 25, 26, 27 and clauses (b) to (i) of sub-regulation (2) of regulation 46 and para C, D and E of Schedule V of SEBI (LODR) Regulations, 2015 are not applicable to our Company. However, our Company has complied with the corporate governance requirement as per the provisions of in terms of the Companies Act, 2013. Our Board has constituted following committees in accordance with the requirements of the Companies Act and SEBI Listing Regulations. Our Board functions either on its own or through committees constituted thereof, to oversee specific operational areas.

- a) Audit Committee;
- b) Stakeholders’ Relationship Committee;
- c) Nomination and Remuneration Committee;
- d) Corporate Social Responsibility Committee and
- e) FPO Committee

a) AUDIT COMMITTEE:

Our Board has constituted the Audit Committee vide Board Resolution dated November 04, 2022 in accordance with the Section 177 of the Companies Act, 2013. The audit committee comprises of following members:

Name of the Directors	Nature of Directorship	Designation in Committee
Rajnish Prakash	Non-Executive Independent Director	Chairman
Priyanka Moondra Rathi,	Non-Executive Independent Director	Member
Sunil Menon	Managing Director	Member

The Audit Committee shall meet at least four times a year with maximum interval of 120 days between two meetings of the Audit Committee.

The role of the Audit Committee shall be in accordance with section 177 of the Companies Act, 2013 and all other applicable provision, if any, of the Companies Act, 2013 and the Companies (Meeting and Its Powers) Rules, 2014, and any other law for the time being enforce. The role of the Audit Committee shall include the following:

- (1) oversight of the Company's financial reporting process and the disclosure of its financial information to ensure that the financial statement is correct, sufficient and credible;
- (2) recommendation for appointment, re-appointment and replacement, remuneration and terms of appointment of statutory auditors of the Company ;
- (3) approval of payments to statutory auditors for any other services rendered by the statutory auditors;
- (4) reviewing, with the management, the annual financial statements and auditor's report thereon before submission to the board for approval, with particular reference to:
 - a. matters required to be included in the director's responsibility statement to be included in the board's report in terms of clause (c) of sub-section (3) of Section 134 of the Companies Act, 2013, as amended;
 - b. changes, if any, in accounting policies and practices and reasons for the same;
 - c. major accounting entries involving estimates based on the exercise of judgment by the management;
 - d. significant adjustments made in the financial statements arising out of audit findings;
 - e. compliance with all legal requirements relating to financial statements; f. disclosure of any related party transactions ; and
 - f. qualifications/modified opinion(s) in the draft audit report;
- (5) reviewing, with the management, the quarterly, half-yearly and annual financial statements before submission to the board for approval;
- (6) reviewing, with the management, the statement of uses / application of funds raised through an issue (public issue, rights issue, preferential issue, etc.), the statement of funds utilized for purposes other than those stated in the offer document / Prospectus / notice and the report submitted by the monitoring agency monitoring the utilisation of proceeds of a public or rights issue, and making appropriate recommendations to the board to take up steps in this matter;
- (7) reviewing and monitoring the statutory auditor's independence and performance, and effectiveness of audit process;
- (8) approval or any subsequent modification of transactions of the Company with related parties and omnibus approval for related party transactions proposed to be entered into by our Company subject to such conditions as may be prescribed;
- (9) formulating a policy on related party transactions, which shall include materiality of related party transactions;
- (10) scrutiny of inter-corporate loans and investments;
- (11) valuation of undertakings or assets of the Company, wherever it is necessary;
- (12) evaluation of internal financial controls and risk management systems;
- (13) establishing a vigil mechanism for directors and employees to report their genuine concerns or grievances;

- (14) reviewing, with the management, performance of statutory and internal auditors, adequacy of the internal control systems;
- (15) reviewing the adequacy of internal audit function, if any, including the structure of the internal audit department, staffing and seniority of the official heading the department, reporting structure coverage and frequency of internal audit;
- (16) discussion with internal auditors of any significant findings and follow up there on;
- (17) reviewing the findings of any internal investigations by the internal auditors into matters where there is suspected fraud or irregularity or a failure of internal control systems of a material nature and reporting the matter to the board;
- (18) discussion with statutory auditors before the audit commences, about the nature and scope of audit as well as post-audit discussion to ascertain any area of concern;
- (19) to look into the reasons for substantial defaults in the payment to the depositors, debenture holders, shareholders (in case of non-payment of declared dividends) and creditors;
- (20) to review the functioning of the whistleblower mechanism;
- (21) approval of appointment of chief financial officer (i.e., the Whole-time Finance Director or any other person heading the finance function or discharging that function) after assessing the qualifications, experience and background, etc. of the candidate; and
- (22) carrying out any other function as is mentioned in the terms of reference of the audit committee and any other terms of reference as may be decided by the Board and/or specified/provided under the Companies Act, 2013 or any other law.

b) STAKEHOLDERS' RELATIONSHIP COMMITTEE:

Our Board has constituted the Stakeholders' Relationship Committee vide Board Resolution dated November 04, 2022 in accordance with the Section 178 of the Companies Act, 2013. The Stakeholders' Relationship Committee comprises of following members:

Name of the Directors	Nature of Directorship	Designation in Committee
Priyanka Moondra Rathi	Non-Executive Independent Director	Chairman
Rajnish Prakash	Non-Executive Independent Director	Member
Gautam Makker	Non-Executive Director	Member

The frequency of meetings of Stakeholders Relationship Committee is at least once in a year.

The role of the Stakeholders Relationship Committee shall be in accordance with Section 178 and all other applicable provision, if any, of the Companies Act, 2013 and the Companies (Meeting and Its Powers) Rules, 2014, and any other law for the time being enforce and is as follows:

- (1) efficient transfer of shares including review of cases for refusal of transfer/transmission of shares and debentures;
- (2) redressing of shareholders and investor complaints such as non-receipt of declared dividend, annual report, transfer of Equity Shares and issue of duplicate/split/consolidated share certificates;
- (3) monitoring transfers, transmissions, dematerialization, re-materialization, splitting and consolidation of Equity Shares and other securities issued by our Company, including review of cases for refusal of transfer/transmission of shares and debentures;
- (4) allotment and listing of shares in future;
- (5) review of cases for refusal of transfer/transmission of shares and debentures;
- (6) reference to statutory and regulatory authorities regarding investor grievances;

- (7) ensure proper and timely attendance and redressal of investor queries and grievances; and
- (8) to do all such acts, things or deeds as may be necessary or incidental to the exercise of the above powers.

c) NOMINATION AND REMUNERATION COMMITTEE:

Our Board has constituted the Nomination and Remuneration Committee vide Board Resolution dated November 04, 2022 in accordance with the Section 177 of the Companies Act, 2013. The Nomination and Remuneration Committee comprises of following members:

Name of the Directors	Nature of Directorship	Designation in Committee
Priyanka Moondra Rathi	Non-Executive Independent Director	Chairman
Rajnish Prakash	Non-Executive Independent Director	Member
Gautam Makker	Non-Executive Director	Member

The Nomination and Remuneration Committee shall meet at once a year.

The role of the Nomination and Remuneration Committee shall be in accordance with Section 178 and all other applicable provision, if any, of the Companies Act, 2013 and the Companies (Meeting and Its Powers) Rules, 2014, and any other law for the time being enforce as follows:

- (1) formulation of the criteria for determining qualifications, positive attributes and independence of a director and recommend to the board of directors a policy relating to, the remuneration of the directors, key managerial personnel and other employees;
- (2) formulation of criteria for evaluation of performance of independent directors and the board of directors;
- (3) devising a policy on diversity of board of directors;
- (4) identifying persons who are qualified to become directors and who may be appointed in senior management in accordance with the criteria laid down, and recommend to the board of directors their appointment and removal;
- (5) whether to extend or continue the term of appointment of the independent director, on the basis of the report of performance evaluation of independent directors.
- (6) analysing, monitoring and reviewing various human resource and compensation matters;
- (7) determining our Company's policy on specific remuneration packages for executive directors including pension rights and any compensation payment, and determining remuneration packages of such directors;
- (8) determining compensation levels payable to the senior management personnel and other staff (as deemed necessary), usually consisting of a fixed and variable component;
- (9) reviewing and approving compensation strategy from time to time in the context of the then current Indian market in accordance with applicable laws;
- (10) framing suitable policies, procedures and systems to ensure that there is no violation, by any employee of any applicable laws in India or Overseas;
- (11) performing such other activities as may be delegated by the Board of Directors and/or specified/provided under the Companies Act, 2013

d) CORPORATE SOCIAL RESPONSIBILITY COMMITTEE:

Our Board has constituted the Corporate Social Responsibility Committee vide Board Resolution dated November 04, 2022 in accordance with the Section 135 of the Companies Act, 2013. The Corporate Social Responsibility Committee comprises of following members:

Name of the Directors	Nature of Directorship	Designation in Committee
Sunil Menon	Managing Director	Chairman

Gautam Makker	Non- Executive Director	Member
Prakash Rajnish	Independent Director (ID)	Member

The role of the Corporate Social Responsibility Committee shall be in accordance with Section 135 and all other applicable provision, if any, of the Companies Act, 2013 along with the rules made thereunder, and any other law for the time being enforce as follows:

- (1) formulate and recommend to the Board of Directors, a Corporate Social Responsibility Policy which shall indicate the activities to be undertaken by the Company;
- (2) recommend the amount of expenditure to be incurred by the Company for CSR;
- (3) monitor the Corporate Social Responsibility Policy of the Company from time to time; and
- (4) to do all such acts, things or deeds as may be necessary or incidental to the exercise of the above powers

e) FPO COMMITTEE

Our Board has constituted the FPO Committee vide Board Resolution dated November 07, 2024. The FPO Committee comprises of following members:

Name of the Directors	Nature of Directorship	Designation in Committee
Sunil Menon	Managing Director	Chairman
Gautam Makker	Chairman and Non- Executive Director	Member
Hitesh Birla	Chief Financial Officer	Member

The Company Secretary shall act as the secretary of the FPO Committee.

The terms of reference of the FPO Committee include the following:

1. Approving amendments to the memorandum of association and the articles of association of the Company;
2. Approving all actions required to dematerialize the Equity Shares, including seeking the admission of the Equity Shares into the Central Depository Services (India) Limited (the “CDSL”) and the National Securities Depository Limited (the “NSDL”);
3. Finalizing and arranging for the submission of the Draft Prospectus (“**DP**”) and the Prospectus (“**Prospectus**”) and any amendments, supplements, notices or corrigenda thereto, to appropriate government and regulatory authorities, institutions or bodies;
4. Approving a code of conduct as may be considered necessary by the Board or the FPO Committee or as required under Applicable Laws for the Board, officers of the Company and other employees of the Company;
5. Issuing advertisements as it may deem fit and proper in accordance with Applicable Laws;
6. Approving suitable policies, including on insider trading, whistle blower/vigil mechanism, risk management and other corporate governance requirement that may be considered necessary by the Board or the FPO Committee or as may be required under Applicable Laws in connection with the Offering;
7. Deciding on the size and all other terms and conditions of the Offer and/or the number of Equity Shares to be offered in the Offer, including Reservation, Green Shoe Option and any rounding off in the event of any oversubscription as permitted under Applicable Laws;
8. Taking all actions as may be necessary or authorized in connection with the Offer;
9. Appointing and instructing Lead Manager, placement agents, bankers to the Offer, the registrar to the Offer, bankers of the Company, managers, underwriters, guarantors, escrow agents, accountants, auditors, legal counsel, depositories, trustees, custodians, credit rating agencies, advertising agencies and all such persons or agencies as may be involved in or concerned with the Offer and whose appointment is required in relation to the Offer, including any successors or replacements thereof;
10. Opening bank accounts, share/securities accounts, escrow or custodian accounts, in India or abroad, in Rupees or in any other currency, in accordance with Applicable Laws;

11. Entering into agreements with, and remunerating all such Lead Manager, placement agents, bankers to the Offer, the registrar to the Offer, bankers of the Company, managers, underwriters, guarantors, accountants, auditors, legal counsel, depositories, trustees, custodians, credit rating agencies, advertising agencies, and all other agencies or persons as may be involved in or concerned with the Offer, including any successors or replacements thereof, by way of commission, brokerage, fees or the like;
12. Seeking the listing of the Equity Shares on the Stock Exchange, submitting listing application to the Stock Exchange and taking all such actions as may be necessary in connection with obtaining such listing, including, without limitation, entering into the listing agreement with the Stock Exchange;
13. Seeking, if required, the consent of the Company's lenders and lenders of its Subsidiary, parties with whom the Company has entered into various commercial and other agreements, all concerned government and regulatory authorities in India or outside India, and any other consents that may be required in connection with the Offer;
14. Submitting undertaking/certificates or providing clarifications to the SEBI and the Stock Exchange;
15. Determining the price at which the Equity Shares are issued to investors in the Offer in accordance with Applicable Laws, in consultation with the Lead Manager and/or any other advisors, and determining the discount, if any, proposed to be issued to eligible categories of investors;
16. Determining the price band and minimum lot size for the purpose of bidding, any revision to the price band and the final Offer Price after bid closure;
17. Determining the FPO Opening Date & Closing Date,;
18. Finalizing the basis of allocation of Equity Shares to retail investors/non-institutional investors/qualified institutional buyers and any other investor in consultation with the Lead Manager, the Stock Exchange and/or any other entity;
19. Opening with the bankers to the Offer, escrow collection banks and other entities such accounts as are required under Applicable Laws;
20. To issue receipts/allotment letters/confirmations of allotment notes either in physical or electronic mode representing the underlying equity shares in the capital of the Company with such features and attributes as may be required and to provide for the tradability and free transferability thereof as per market practices and regulations, including listing on one or more Stock Exchange(s), with power to authorise one or more officers of the Company to sign all or any of the aforesaid documents;
21. Severally authorizing Sunil Menon and Gautam Makker ("Authorized Directors"), for and on behalf of the Company, to execute and deliver, on a several basis, any agreements and arrangements as well as amendments or supplements thereto that the Authorized Officers consider necessary, desirable or expedient, in connection with the Offer, including, without limitation, engagement letters, memorandum of understanding, the listing agreement with the Stock Exchange, the Registrar Agreement, the depositories' agreements, the offer agreement with the Lead Manager (and other entities as appropriate), the underwriting agreement, confirmation of allocation notes, the advertisement agency agreement and any undertakings and declarations, and to make payments to or remunerate by way of fees, commission, brokerage or the like or reimburse expenses incurred in connection with the Offer, the Lead Manager, placement agents, bankers to the Offer, registrar to the Offer, bankers of the Company, managers, underwriters, guarantors, accountants, auditors, legal counsel, depositories, trustees, custodians, credit rating agencies, advertising agencies, and all such persons or agencies as may be involved in or concerned with the Offer including any successors or replacements thereof; and any such agreements or documents so executed and delivered and acts, deeds, matters and things done by any such Authorized Officers shall be conclusive evidence of the authority of the Authorized Officers and the Company in so doing;
22. Severally authorizing the Authorized Officers to take any and all action in connection with making applications, seeking clarifications and obtaining approvals (or entering into any arrangement or agreement in respect thereof) in connection with the Offer, including, without limitation, applications to, and clarifications or approvals from the GoI, the RBI, the SEBI, the RoC, and the Stock Exchange and that any such action already taken or to be taken is hereby ratified, confirmed and/or approved as the act and deed of the Authorized Officers and the Company, as the case may be;

23. Severally authorizing the Authorized Officers, for and on behalf of the Company, to execute and deliver any and all documents, papers or instruments and to do or cause to be done any and all acts, deeds, matters or things as any such Authorized Officers may deem necessary, desirable or expedient in order to carry out the purposes and intent of the foregoing resolutions or the Offer; and any documents so executed and delivered or acts, deeds, matters and things done or caused to be done by any such Authorized Officers shall be conclusive evidence of the authority of such Authorized Officers and the Company in so doing and any such document so executed and delivered or acts, deeds, matters and things done or caused to be done by any such Authorized Officers prior to the date hereof are hereby ratified, confirmed and approved as the act and deed of the Authorized Officers and the Company, as the case may be; and
24. Executing and delivering any and all documents, papers or instruments and doing or causing to be done any and all acts, deeds, matters or things as the FPO Committee may deem necessary, desirable or expedient in order to carry out the purposes and intent of the foregoing resolutions or the Offer; and any documents so executed and delivered or acts, deeds, matters and things done or caused to be done by the FPO Committee shall be conclusive evidence of the authority of the FPO Committee in so doing.

Management Organizational Structure

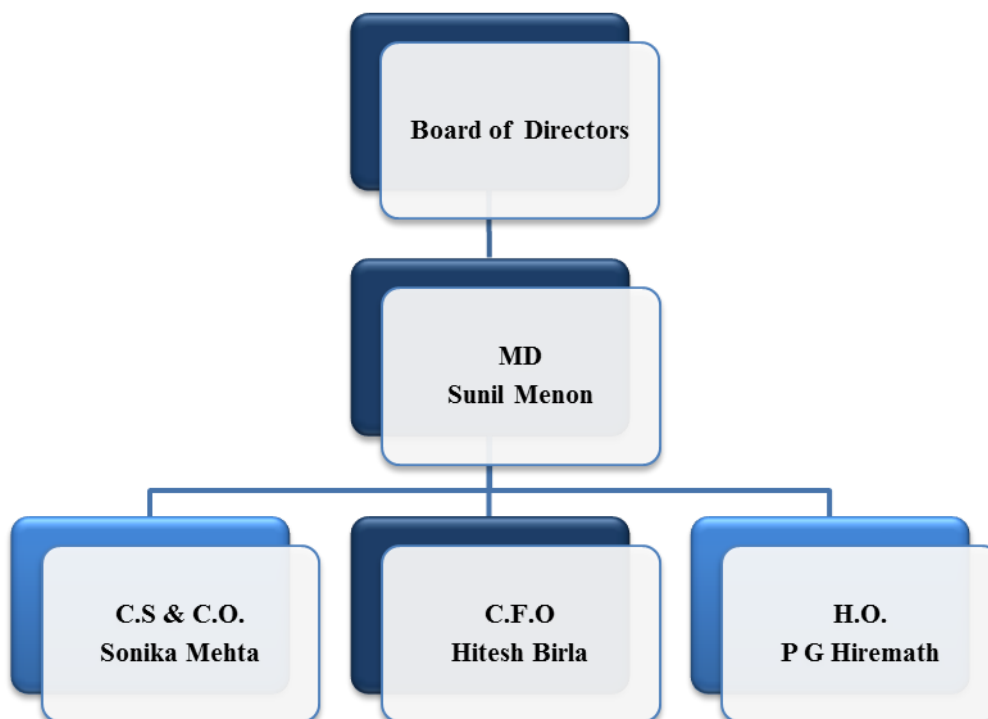

Terms & Abbreviations

MD	-	Managing Director
C.F.O.	-	Chief Financial Officer
C.S & C.O.	-	Company Secretary and Compliance Officer
H.O.	-	Head Operational

KEY MANAGERIAL PERSONNEL AND SENIOR MANAGER

Our Company is managed by our Board of Directors, assisted by qualified and experienced professionals, who are permanent employees of our Company. Below are the details of the Key Managerial Personnel and Senior Manager of our Company:

Name of Employee	Designation	Date of Appointment	Compensation for last Financial Year (₹ in Lakhs)	Qualification	Name of Previous Employer(s)	Total Years of Experience
Hitesh Birla	Chief Financial Officer	August 01, 2022	12.73	• Chartered Accountant	• Flash Forge Pvt. Limited. • Murli Industries Limited.	19 Years
P.G. Hiremath	Head Operation	July 02, 2013	30.50	• MBA • B.E. Mechanical	• M/s. NSSL Limited	26 Years
Sonika Mehta*	Company Secretary and Compliance Officer	November 04, 2022	2.24	• Company Secretary • B.Com	• PCS Neelam Bhandari	3 Years

*Prior to her marriage, she was known as Sonika Pansari; she now goes by Sonika Mehta.

Other Confirmations

- Further, our Company has not entered into any service contracts, pursuant to which it's KMPs and Senior Manager are entitled to benefits upon termination of employment. Except statutory benefits upon termination of their employment in our Company or superannuation, no KMPs and Senior Manager are entitled to any benefit upon termination of employment or superannuation.
- There is no arrangement or understanding with major shareholders, customers, suppliers or any others pursuant to which any of the abovementioned KMPs and Senior Manager have been recruited.
- All the key managerial personnel and Senior Manager mentioned above are permanent employees of our Company and none of them are related to each other or to any Director of our Company.
- As on the date of filing of this DP, our Company does not have a performance linked bonus or a profit sharing plan with the KMPs and Senior Manager.
- There is no contingent or deferred compensation payable to our KMPs and Senior Manager, which does not form part of their remuneration.
- No non-salary-related payments or benefits have been made to our KMPs and Senior Manager based on targets achieved and general performance.
- Attrition of KMPs and Senior Manager in the Company is not high as compared to the industry.

RELATIONSHIP AMONGST THE KEY MANAGEMENT PERSONNEL, SENIOR MANAGER AND DIRECTORS

None of the aforementioned KMPs and Senior Manager is related to each other and Directors.

SHAREHOLDING OF THE KEY MANAGEMENT PERSONNEL AND SENIOR MANAGER

None of our Key Managerial Personnel and Senior Manager hold Equity Shares as on the date of this Draft Prospectus.

SERVICE CONTRACTS WITH KEY MANAGERIAL PERSONNEL AND SENIOR MANAGER

Our Key Managerial Personnel and Senior Manager have not entered into any service contracts with our Company which provide for any benefits upon termination of their employment in our Company.

INTEREST OF KEY MANAGERIAL PERSONNEL AND SENIOR MANAGER

None of our Key Management Personnel and Senior Manager has any interest in our Company except to the extent of their remuneration, benefits, reimbursement of expenses incurred by them in the ordinary course of business. Our Key Managerial Personnel may also be interested to the extent of Equity Shares, if any, held by them and any dividend payable to them and other distributions in respect of such Equity Shares.

LOANS TAKEN BY KEY MANAGEMENT PERSONNEL AND SENIOR MANAGER

None of our Key Managerial Personnel and Senior Manager have any outstanding loan from our Company as on the date of this Draft Prospectus.

ARRANGEMENT OR UNDERSTANDING WITH MAJOR SHAREHOLDERS/ CUSTOMERS/ SUPPLIERS

There are no arrangements or understanding with major shareholders, customers, suppliers or others, pursuant to which any of the Key Managerial Personnel and Senior Manager was selected as a member of our senior management.

BONUS OR PROFIT SHARING PLAN OF THE KEY MANAGEMENT PERSONNEL AND SENIOR MANAGER

There is no profit sharing plan for the Key Managerial Personnel and Senior Manager. Our Company makes payment for salaries, insurance and bonus payments, in accordance with their terms of appointment.

CONTINGENT AND DEFERRED COMPENSATION PAYABLE TO KEY MANAGERIAL PERSONNEL AND SENIOR MANAGER

There is no contingent or deferred compensation payable to our Key Managerial Personnel and Senior Manager, which does not form part of their remuneration.

EMPLOYEE SHARE PURCHASE AND EMPLOYEE STOCK OPTION PLAN

Presently, we do not have ESOP/ESPS scheme for employees.

PAYMENT OR BENEFIT TO OUR KEY MANAGERIAL PERSONNEL AND SENIOR MANAGER

No amount or benefit has been paid or given to any officer of our Company within the two years preceding the date of filing of this Draft Prospectus, or is intended to be paid or given, other than in the ordinary course of their employment.

CHANGES IN OUR KEY MANAGERIAL PERSONNEL AND SENIOR MANAGER IN THE LAST THREE YEARS FROM THE DATE OF FILING OF THIS DRAFT PROSPECTUS

The changes in our Key Managerial Personnel and Senior Manager during the three years immediately preceding the date of filing of this Draft Prospectus are set forth below.

Name	Designation	Date of Appointment / Change in Designation	Reason
Hitesh Birla	Chief Financial Officer	August 01, 2022	Appointment
Sonika Mehta	Company Secretary and Compliance Officer	November 04, 2022	Appointment

OUR PROMOTER AND PROMOTER GROUP



Our Promoters

The Promoters of our Company are Sunil Menon and Gautam Makker.

As on the date of this Draft Prospectus, our Promoters, in aggregate, hold 1,14,94,600 Equity Shares in our Company, representing 59.03% of the issued, subscribed and paid-up Equity Share capital of our Company.

For details of the build-up of our Promoters' shareholding in our Company, see "*Capital Structure - Shareholding of our Promoters*" beginning on page no. 53 of this Draft Prospectus.

The details of our Promoter are as under:

Sunil Menon	
	<p>Sunil Menon, aged 57 years, is the Promoter and Managing Director of our Company.</p> <p>For details of his residential address, date of birth, educational qualifications, professional experience, other directorships, positions / posts held in the past and other directorships, other ventures and special achievements, see the chapter titled "<i>Our Management</i>" on page no 120 of this Draft Prospectus.</p> <p>Permanent account number: AERPM5344Q</p>
Gautam Makker	
	<p>Gautam Makker, aged 55 years, is the Promoter, Chairman and Non - Executive Director of our Company.</p> <p>For details of his residential address, date of birth, educational qualifications, professional experience, other directorships, positions / posts held in the past and other directorships, other ventures and special achievements, see the chapter titled "<i>Our Management</i>" on page no 120 of this Draft Prospectus.</p> <p>Permanent account number: AGQPM2281D</p>

Confirmations/declarations:

Our Company confirms that the permanent account numbers, bank account number(s), the passport numbers, Aadhaar card number and driving license of each of our Promoters shall be submitted to the Stock Exchange at the time of filing of the Draft Prospectus.

Our Promoter and the members of our Promoter Group have confirmed that they have not been identified as wilful defaulter or a fraudulent borrower by the RBI or any other governmental authority.

Our Promoters have not been declared as a fugitive economic offender under the provisions of section 12 of the Fugitive Economic Offenders Act, 2018.

No violations of securities laws have been committed by our Promoters or members of our Promoter Group or any Group Companies in the past or are currently pending against them. None of (i) our Promoters and members of our Promoter Group or persons in control of or on the boards of bodies corporate forming part of our Group Companies (ii) the Companies with which any of our Promoters are or were associated as a promoters, director or person in control, are debarred or prohibited from accessing the capital markets or restrained from buying, selling, or dealing in securities under any order or directions passed for any reasons by the SEBI or any other authority or refused listing of any of the securities issued by any such entity by any stock exchange in India or abroad.

Change in Control of our Company

There has not been any change in the control of our Company in the five years immediately preceding the date of this Draft Prospectus.

Experience of our Promoter in the Business of our Company

For details in relation to experience of our Promoters in the business of our Company, please refer to the chapter titled “*Our Management*” beginning on page no. 120 of this Draft Prospectus.

Interest of Promoter

None of our Promoter / Directors have any interest in our Company except to the extent of compensation payable / paid, rents on properties owned by their relatives but used by our company and reimbursement of expenses (if applicable) and to the extent of any equity shares held by them or their relatives and associates or held by the companies, firms and trusts in which they are interested as director, member, partner, and / or trustee, and to the extent of benefits arising out of such shareholding. For further details please see the chapters titled “*Capital Structure*”, “*Financial Information*” and “*Our Management*” on page nos. 53, 140 and 120 of this Draft Prospectus.

Except as stated otherwise in this Draft Prospectus, we have not entered into any contract, agreements or arrangements in which our Promoters are directly or indirectly interested and no payments have been made to them in respect of the contracts, agreements or arrangements which are proposed to be made with them including the properties purchased by our Company other than in the normal course of business.

Interest in promotion of our Company

Our Company is currently promoted by the promoters in order to carry on its present business. Our Promoters are interested in our Company to the extent of their shareholding and directorship in our Company and the dividend declared, if any, by our Company.

Interest in the Property of our Company

Our Promoters have confirmed that they do not have any interest in any property acquired by our Company within three years preceding the date of this Draft Prospectus or proposed to be acquired by our Company as on the date of this Draft Prospectus except as mentioned under the chapter titled “*Our Business - Properties*” and “*Financial Information*” on page nos. 89 and 140 respectively, of this Draft Prospectus.

Other Interest in our Company

Except as stated in this section and the chapter titled “*Our Management*”, “*Related Party Transactions-Financial Information*” on page no 120 and 140 respectively, our Promoters do not have any interest in our Company other than as a Promoter.

Our Promoters are not interested in any transaction in acquisition of land or property, construction of building and supply of machinery, or any other contract, agreement or arrangement entered into by the Company.

Payment of Amounts or Benefits to the Promoter or Promoter Group During the last two years

Except as stated in this chapter and the chapter titled “*Financial Information- Annexure V- Note no. 26 of Restated Financial Statements*” on page no. 140 of this Draft Prospectus, there has been no payment of benefits to our Promoter or Promoter Group during the two years preceding the date of this Draft Prospectus.

Material Guarantees

Except as stated in the chapter titled “*Financial Indebtedness*” and “*Financial Information*” on page nos. 170 and 140 of this Draft Prospectus respectively, our Promoters have not given any material guarantee to any third party with respect to the Equity Shares as on the date of this Draft Prospectus.

Our Promoter Group

In addition to our Promoters, the following individuals, companies, partnerships and HUFs, etc. form part of our Promoter Group in terms of Regulation 2(1) (pp) of the SEBI ICDR Regulations:

Individuals forming part of the Promoter Group:

Name of the Promoters	Name of Relative	Relationship with the Promoter
Sunil Menon	Late CK Menon	Father
	Sathi Krishnankutty Menon	Mother
	Late Shalini Menon	Spouse
	NA	Brother
	Sajita C Menon	Sister
	NA	Son
	Nayantara Menon	Daughter
	Latikaa Menon	Daughter
	Niranjan Dev Makker	Spouse’s father
	Sheila Makker	Spouse’s mother
	Gautam Makker	Spouse’s brother
Gautam Makker	NA	Spouse’s sister
	Niranjan Dev Makker	Father
	Sheila Makker	Mother
	NA	Spouse*
	NA	Brother
	Late Shalini Menon	Sister
	Raoul Faleiro Makker	Son
	Samara Maria Makker	Daughter
	NA	Spouse’s father
	NA	Spouse’s mother
NA	Spouse’s brother	
NA	Spouse’s sister	

* *Gautam Makker was married to Shaila Faleiro and has been separated as per conciliation settlement agreement dated 09 January, 2022, further, official divorce is under process*

Entities Forming Part of the Promoter Group

Except as stated below, no other company, firm or HUF are forming part of the promoter group:

Sr. No.	Name of the entity
1.	Aar Aar Consultancy Services Private Limited
2.	Airotech Profiles (India) Private Limited
3.	Amber Durables Goods Pvt Ltd
4.	Autostem Technologies India Private Limited
5.	FF Flowline Private Limited
6.	Flash Forge Private Limited
7.	Navigating Sales Private Limited
8.	Pushpak Advisory Private Limited
9.	Signet Infotech Pvt Ltd

Shareholding of the Promoter Group in our Company

For details of shareholding of members of our Promoter Group as on the date of this Draft Prospectus, please see the chapter titled “*Capital Structure – Notes to Capital Structure*” beginning on page no. 53 of this Draft Prospectus.

Companies with which the Promoter has disassociated in the last three years

Except as disclosed below, our Promoters have not disassociated themselves from any companies, firms or entities during the last three years preceding the date of this Draft Prospectus”

Name of the Promoter	Companies or firms with which Promoter(s) have disassociated	Reasons and circumstances of disassociation	Date of disassociation
Gautam Makker	Pushpak Advisory Private Limited	Resignation on account of being Pre-occupied	August 22, 2022
Gautam Makker	Signet Infotech Pvt Ltd	Resignation on account of being Pre-occupied	February 01, 2018

Outstanding Litigation

There is no outstanding litigation against our Promoters except as disclosed in the chapter titled “*Risk Factors*” and chapter titled “*Outstanding Litigation and Material Developments*” beginning on page nos. 20 and 173 of this Draft Prospectus.

OUR GROUP COMPANIES

In terms of the SEBI ICDR Regulations, the term —Group Company includes such companies (other than Promoters and subsidiaries) with which there were related party transactions as disclosed in the Restated Financial Statements, as covered under the applicable accounting standards, and also other companies as considered material by our Board. Pursuant to a resolution dated November 07, 2024, our Board has noted that in accordance with the SEBI ICDR Regulations and for the purpose of disclosure in this Draft Prospectus, group companies of our Company shall include (i) the companies with which there were related party transactions as disclosed in the Restated Financial Statements; or (ii) such other company as deemed material by our Board.

Accordingly, Flash Forge Private Limited is identified as our Group Company.

The details of our Group Company are provided below:

1. FLASH FORGE PRIVATE LIMITED (FFPL)

Corporate Information

Flash Forge Private Limited was incorporated on July 005, 1991 under the Companies Act, 1956 as a Private Limited Company, bearing Registration No. 187895. The CIN of FFPL is U99999MH1991PTC187895. The Registered Office is situated at 11, R.K. Industry House Walbhot Road, Goregaon (East) Mumbai-400063.

Nature of business

1. To carry on the business of designing, casting, forging, manufacturing, fabricating, selling, sheeting, stamping, pressing, extruding, drawing, flattening, molding, straightening, heat treatment of all kinds of ferrous and non-ferrous materials, metals and alloys for all kinds of custom valves, heat exchangers, fittings, pipes and tubes and other solutions, in respect of oil and gas, defense, power, railways, aerospace, marine, and other industries, which require high quality custom solutions for critical applications.
2. To carry on with the business of Designing, Shipbuilding (self-propelled), building various types/ capacities of Barges, Ferry Crafts, Boats, Fast attack crafts/vessels, Hovercrafts, Coastal passenger vessels, all types of Cargo vessels, Offshore Patrol Vessels, Accommodation Barges, Pontoons etc., all these being non-propelled & self-propelled, pertaining to Naval and Marine industry and to undertake their Repairs/ Refits.
3. To carry on with the business of manufacturing and otherwise undertaking and providing services related to the Naval and Marine Industry, Aircrafts/ Helicopters/Drones, Armoured Vehicles, Hydraulic Deck Machinery, Horizontal and vertical Windlasses, Chain Stoppers and Cargo Winches, Automatic Self-tensioning Mooring Winches, Cargo and Store Cranes, all models of Marine Vessels and Structures for all types of Cargo Vessels, ship brokers.
4. To be engaged in the business of purchase, sell, acquire, manufacture, build, repair or otherwise deal in supply of Locomotives, Locomotive Spares and parts, rolling stock, spares, raw materials, stores, fixtures, fittings, accessories, consumables, ingredients in this respect.
5. To be engaged as dealers, agents, distributors of medical and surgical appliances, scientific apparatus, equipments, appliances, instruments, along with drugs of all kinds, including bio-medical, generic, non-generic, patented, bulk drugs and pharmaceuticals of every description with indigenous and/or imported technology, pharmaceutical formulations like liquids, capsules, tablets, powders, mixtures, antibiotics enzymes and fluids of every description, all intermediates and by-products of any of the above, surgical and health aids of varied nature like.

Financial Information

The financial information derived from the audited financial statements of Flash Forge Private Limited for the last three financial years, as required by the SEBI ICDR Regulations is available on the website of our Company at <https://cffdefensys.com/>

Material Litigations

There has been no material litigation arisen in the group company, which may directly or indirectly affect our Company except as disclosed under the chapter “*Outstanding Litigation and Material Developments*” on page no. 173 of this Draft Prospectus.

Common Pursuits

Flash Forge Private Limited (FFPL) have been authorised by its Memorandum of Associations to undertake activities which is similar to that of our Company. Further, currently we do not have any non-compete agreement/arrangement with our Group Company. Such a conflict of interest may have adverse effect on our business and growth. We shall adopt the necessary procedures and practices as permitted by law to address any conflict situations, as and when they may arise.

Related Party Transactions and Significance on the Financial Statements

For details, please refer to the chapter titled “*Financial Information- Annexure V- Note no. 26 of Restated Financial Statements*” beginning on page no. 140 of this Draft Prospectus.

Business Interests or Other Interests

Except as disclosed in “*Financial Statements*” on page no. 140 of this Draft Prospectus, our Group Company has no business interest in our Company.

Other Confirmations

Our Group Company does not have any securities listed on any Stock Exchange. Further, our Group Company has not made any public or rights issue (as defined under the SEBI ICDR Regulations) of securities in the three years preceding the date of this Draft Prospectus.

Further, neither have any of the securities of our Company or our Group Company been refused listing by any stock exchange in India or abroad, nor has our Company or our Group Company failed to meet the listing requirements of any stock exchange in India or abroad.

DIVIDEND POLICY

The declaration and payment of dividends on our Equity Shares, if any, will be recommended by our Board and approved by our Shareholders, at their discretion, subject to the provisions of the Articles of Association and the applicable laws including the Companies Act, read with the rules notified thereunder, each as amended. We may retain all our future earnings, if any, for purposes to be decided by our Company, subject to compliance with the provisions of the Companies Act. The quantum of dividend, if any, will depend on a number of factors, including but not limited to profits earned and available for distribution during the relevant Financial Year, accumulated reserves including retained earnings, expected future capital/expenditure requirements, organic growth plans/expansions, proposed long-term investment, capital restructuring, debt reduction, crystallization of contingent liabilities, cash flows, current and projected cash balance, and external factors, including but not limited to the macro-economic environment, regulatory changes, technological changes and other factors

In addition, our ability to pay dividends may be impacted by a number of factors, including restrictive covenants under our current or future loan or financing documents. The amounts declared as dividends in the past are not necessarily indicative of our dividend amounts, if any, in the future. For more information on restrictive covenants under our current loan agreements, see “*Financial Indebtedness*” on page 170 Our Company may pay dividend by cheque, or electronic clearance service, as will be approved by our Board in the future. Our Board may also declare interim dividend from time to time.

Except as disclosed below, our company has not declared any dividends during the last three Financial Years.

Particulars	As on November 15, 2023	As on September 20, 2024	As on November 18, 2024
No. of Equity Shares	1,94,74,100	1,94,74,100	1,94,74,100
Face value of Equity Shares (in ₹)	10	10	10
Dividend per Equity share (in ₹)	0.50	0.50	0.50
Total amount of dividend paid	97,37,050	97,37,050	97,37,050
Dividend rate (%)	5%	5%	5%
Mode of Payment	Bank Transfer	Bank Transfer	Bank Transfer

(The remainder of this page is intentionally left blank)

SECTION VII- FINACIAL INFORMATION

RESTATED FINANCIAL INFORMATION

To,

**The Board of Directors,
CFF Fluid Control Limited**
Plot No 01, Survey No 96, Kumbhivli Madap,
Khopoli IN, Khalapur Raigad,
Raigarh MH 410203

Dear Sir/Ma'am,

1. We have examined the attached Restated Financial Statement along with the Significant Accounting Policies and related notes of CFF Fluid Control Limited (the 'Company') as at and for the period ended on September 30, 2024, financial year ended March 31, 2024, March 31, 2023 and March 31, 2022 annexed to this report and prepared by the Company for the purpose of inclusion in the Draft Offer Document (being collectively referred as "Offer Document") in connection with its proposed Further Public Offer ("FPO") on the SME Platform of the BSE Limited ("BSE").
2. The said Restated Financial Statements and other Financial Information have been prepared in accordance with the requirements of:
 - i) Section 26 of Part I of Chapter III to the Companies Act, 2013("the Act") read with Companies (Prospectus and Allotment of Securities) Rules 2014;
 - ii) The Securities and Exchange Board of India (Issue of Capital and Disclosure Requirements) Regulations 2018 ("ICDR Regulations") issued by the Securities and Exchange Board of India ("SEBI") in pursuance to Section 11 of the Securities and Exchange Board of India Act, 1992 and related amendments / clarifications from time to time;
 - iii) The terms of reference to our engagements with the Company requesting us to carry out the assignment, in connection with the Offer Document being issued by the Company for its proposed FPO of equity shares on SME Platform of the BSE Limited ("BSE"); and
 - iv) The Guidance Note on Reports in Company Prospectus (Revised 2019) issued by the Institute of Chartered Accountants of India ("Guidance Note").
3. We have examined the accompanied 'Restated Statement of Profit and Loss' (Annexure – II) for the period ended on September 30, 2024 and for the financial year ended on March 31, 2024, March 31, 2023 and March 31, 2022, the 'Restated Statement of Assets and Liabilities' (Annexure-I) as on above dates and 'Restated Financial Statement of Cash Flows' (Annexure-III) as on above dates, forming part of the 'Financial Information' dealt with by this Report, detailed below. Both read together with the Significant Accounting Policies and Notes to Accounts (Annexure – IV & V) thereon. The Restated Financial Information has been prepared by Company's management. The information has been extracted from the financial statements for the period ended on September 30, 2024 and for financial year ended on March 31, 2024, March 31, 2023 and March 31, 2022. The Financial Statements for the period ended on September 30, 2024, March 31, 2024, March 31, 2023 and March 31, 2022 is audited by us, V.N Purohit & Co being the Statutory Auditor for the respective period, which was approved by the Board of Directors as on November 07, 2024, May 29, 2024, July 31, 2024 and September 15, 2022 respectively and upon which we have placed our reliance while reporting.
4. In terms of Schedule VI (Part A) (11) (II) (i) of the SEBI (ICDR) Regulations, 2018 and other provisions relating to accounts of CFF Fluid Control Limited, we, V.N Purohit & Co, Chartered Accountants, have been subjected to the peer review process of the Institute of Chartered Accountants of India (ICAI) and hold a valid certificate issued by the Peer Review Board of the ICAI.
5. Based on our examination, we report that:

- a. The “Restated Financial Statement of Assets and Liabilities” as set out in Annexure I, “Restated Financial Statement of Profit and Loss” as set out in Annexure II and “Restated Financial Statement of Cash Flows” as set out in Annexure III to this report, of the Company as at September 30, 2024, March 31, 2024, March 31, 2023 and March 31, 2022 is prepared by the Company and approved by the Board of Directors. These Restated Financial Statements have been arrived at after making such adjustments and regroupings to the financial statements of the Company, as in our opinion were appropriate and more fully described in Significant Accounting Policies and Notes to Accounts as set out in Annexure IV & V to this Report.
- b. The Restated Financial Statements have been made after incorporating adjustments for:
 - i. The changes, if any, in accounting policies retrospectively in respective financial years to reflect the same accounting treatment as per the changed accounting policy for all the reporting period /years.
 - ii. Prior period and other material amount in the respective financial years to which they relate.
 - iii. Extra-ordinary items, if any, that needs to be disclosed separately in the accounts requiring adjustments, which are stated in the Notes to Accounts as set out in Annexure V.
- c. There were no qualifications in the Audit Reports issued by Statutory Auditor(s) for the period ended on September 30, 2024, March 31, 2024, March 31, 2023 and March 31, 2022.
6. At the request of the company, we have also examined the following financial information ("Other Financial Information") proposed to be included in the offer document prepared by the management and approved by the board of directors of the company and annexed to this report:

Annexure of Restated Financial Statements of the Company: -

- i. Statement of Equity Share Capital, as restated (Note– 3 of Annexure V)
- ii. Statement of Reserves & Surplus, as restated (Note - 4 of Annexure V)
- iii. Statement of Long- Term Borrowings, as restated (Note- 5 of Annexure V)
- iv. Statement of Long- Term Provisions, as restated (Note- 6 of Annexure V)
- v. Statement of Short- Term Borrowings, as restated (Note-7 of Annexure V)
- vi. Statement of Trade Payables, as restated (Note8 of Annexure V)
- vii. Statement of Other Current Liabilities, as restated (Note - 9 of Annexure V)
- viii. Statement of Short- Term Provisions, as restated (Note- 10 of Annexure V)
- ix. Statement of Property, Plant and Equipment, as restated (Note- 11 of Annexure V)
- x. Statement of Deferred Tax Assets, as restated (Note- 12 of Annexure V)
- xi. Statement of Other Non-Current Assets, as restated (Note - 13 of Annexure V)
- xii. Statement of Inventories, as restated (Note- 14 of Annexure V)
- xiii. Statement of Trade Receivables, as restated (Note- 15 of Annexure V)
- xiv. Statement of Cash and Bank Balances, as restated (Note - 16 of Annexure V)
- xv. Statement of Short Terms Loans and Advances, as restated (Note- 17 of Annexure V)
- xvi. Statement of Other Current Assets, as restated (Note - 18 of Annexure V)
- xvii. Statement of Revenue from Operations, as restated (Note – 19 of Annexure V)
- xviii. Statement of Other Income, as restated (Note – 20 of Annexure V)
- xix. Statement of Cost of Materials Consumed, as restated (Note – 21 of Annexure V)
- xx. Statement of Employee Benefit Expenses, as restated (Note – 22 of Annexure V)
- xxi. Statement of Finance Cost, as restated (Note – 23 of Annexure V)
- xxii. Statement of Depreciation, as restated (Note – 24 of Annexure V)
- xxiii. Statement of Other Expenses, as restated (Note – 25 of Annexure V)
- xxiv. Statement of Prior Period Expenses, as restated (Note – 26 of Annexure V)
- xxv. Statement of Related Party Transactions, as restated (Note – 27 of Annexure V)
- xxvi. Statement of Earnings Per Share, as restated (Note- 28 of Annexure V)
- xxvii. Statement of Commitment and Contingent Liabilities, as restated (Note - 29 of Annexure V)
- xxviii. Statement of Ratio Analysis, as restated (Note – 30 of Annexure V)
- xxix. Statement of Employee Benefits, as restated (Note - 31 of Annexure V)
- xxx. Statement of Adjustments to Audited Financial Statements appearing in (Note - 32 of Annexure V)
- xxxi. Statement of Income and Expenditure in foreign currency, as restated (Note - 33 of Annexure V)
- xxxii. Statement of Un-hedged foreign currency exposure (Note-34 of Annexure V)
- xxxiii. Statement of Other Statutory Information, as restated (Note - 35 of Annexure V)
- xxxiv. Statement of Accounting Ratios, as restated (Annexure – VI)
- xxxv. Statement of Capitalization, as restated (Annexure – VII)

7. In our opinion, the Restated Financial Statements and the other Financial Information set forth in Annexure I to VIII read with the significant accounting policies and notes to the restated financial statements have been prepared in accordance with section 26 of Companies Act, 2013 and the SEBI Regulations and the Guidance Note on the reports in Company Prospectus (Revised 2019) issued by the Institute of Chartered Accountants of India (ICAI).

Consequently, the financial information has been prepared after making such regroupings and adjustments as were, in our opinion, considered appropriate to comply with the same. As a result of these regrouping and adjustments, the amount reported in the financial information may not necessarily be the same as those appearing in the respective audited financial statements for the relevant years.

8. This report should not in any way be construed as a re-issuance or re-dating of any of the previous audit reports issued by any other Firm of Chartered Accountants nor should this report be construed as a new opinion on any of the financial statements referred to therein.
9. We have no responsibility to update our report for events and circumstances occurring after the date of the report.
10. This report is intended solely for your information and for inclusion in the Offer document in connection with the Company's proposed FPO of equity shares and is not to be used, referred to or distributed for any other purpose without our prior written consent.

FOR V.N. PUROHIT & CO.

Chartered Accountants

Firm Regn. No. 304040E

O.P. Pareek

Partner

Membership No: 014238

Place: New Delhi

Date: November 07, 2024

UDIN: 24014238BKAUHU4281

Annexure I - Restated Financial Statement of Assets and Liabilities

Rupees in Lakhs, unless otherwise Stated

Particulars	Note to Annexure V	As at September 30, 2024	As at March 31, 2024	As at March 31, 2023	As at March 31, 2022
Equity and Liabilities					
1. Shareholder's fund					
a) Equity share capital	3	1,947.41	1,947.41	1,427.41	71.37
b) Reserves and surplus	4	11,953.45	10,646.21	1,071.52	1,413.96
Total Equity		13,900.86	12,593.62	2,498.93	1,485.33
2. Non-current liabilities					
a) Long term borrowings	5	577.36	639.06	3,025.41	1,104.48
b) Long term provisions	6	31.49	14.70	10.52	7.69
Total Non-current liabilities		608.86	653.76	3,035.92	1,112.17
3. Current liabilities					
a) Short term borrowings	7	1,418.77	1,708.84	1,564.11	554.69
b) Trade payables	8				
- Total outstanding dues of micro enterprises and small enterprises		-	-	-	-
- Total outstanding dues of creditors other than micro enterprises and small enterprises.		1,099.14	243.62	933.91	1,961.07
c) Other current liabilities	9	541.36	458.65	471.57	237.45
d) Short term provisions	10	907.45	457.46	363.56	244.99
Total Current liabilities		3,966.71	2,868.56	3,333.15	2,998.20
Total Equity and liabilities		18,476.42	16,115.94	8,868.00	5,595.70
Assets					
1. Non-Current assets					
(a) Property, Plant and Equipment and Intangible Assets	11				
i) Property, plant and equipment		2,855.46	3,016.70	2,628.39	812.91
ii) Intangible Assets		911.39	4.84	-	-
iii) Intangible Assets under development		-	849.33	-	-
b) Deferred Tax Assets(net)	12	26.29	29.49	3.00	7.65
c) Other non current assets	13	88.12	56.19	45.68	20.50
Total Non-current assets		3,881.26	3,956.54	2,677.08	841.05
2. Current assets					
a) Inventories	14	5,796.14	5,268.18	3,727.78	2,083.36
b) Trade receivables	15	5,210.00	882.30	813.31	1,314.39
c) Cash and cash equivalents	16	416.83	1,727.32	157.91	405.28
d) Short term loans & advances	17	2,177.71	3,287.66	834.88	829.46
e) Other current assets	18	994.47	993.94	657.05	122.15
Total current assets		14,595.16	12,159.40	6,190.93	4,754.64
Total Assets		18,476.42	16,115.94	8,868.00	5,595.70

The above statement should be read with Basis of Preparation and the Significant Accounting Policies appearing in Annexure IV, Notes to the Restated Financial Information appearing in Annexure V & Adjustments to Audited Financial Statements appearing in Annexure VI.

As per our report of even date attached.

For and on behalf of
V. N. PUROHIT & CO.
Chartered Accountants
FRN:304040E

For and on behalf of board of directors
CFF FLUID CONTROL LIMITED
CIN: U28990MH2012PLC227023

Sd/-
O.P. Pareek
Partner
Membership No: 014238
Date : 7th November 2024
Place : New Delhi
UDIN : 24014238BKAUHU4281

Sd/-
Gautam Makkar
Director
DIN: 00354956
Date : 7th November 2024
Place: Mumbai

Sd/-
Sunil Menon
Director
DIN: 00409485
Date : 7th November 2024
Place: Mumbai

Sd/-
Sonika Mehta
Company Secretary
Membership No: A63323
Date : 7th November 2024
Place: Mumbai

Sd/-
Hitesh Birla
Chief Financial Officer
PAN: AOCPB7046K
Date : 7th November 2024
Place: Mumbai

Annexure II - Restated Financial Statement of Profit and Loss

Rupees in Lakhs, unless otherwise Stated

Particulars	Note	For the Period September 30, 2024	For the Year ended March 31, 2024	For the Year ended March 31, 2023	For the Year ended March 31, 2022
Revenue:					
Revenue from operations	19	8,003.41	10,685.91	7,066.63	4,698.77
Other income	20	18.40	11.66	43.31	13.62
Total Income		8,021.81	10,697.57	7,109.94	4,712.39
Expenses:					
Cost of material consumed	21	4,782.86	6,397.09	4,633.30	3,197.20
Employee benefit expenses	22	491.91	413.80	251.06	96.35
Finance costs	23	105.92	239.97	311.07	124.83
Depreciation & amortisation	24	289.41	445.26	131.95	90.79
Other expenses	25	443.09	801.31	340.97	159.28
Prior period expenses	26	-	-	1.80	6.63
Total Expenses		6,113.18	8,297.42	5,670.14	3,675.08
Exceptional items		-	-	-	-
Net Profit before extraordinary items and tax		1,908.63	2,400.15	1,439.80	1,037.31
Extraordinary Items		-	-	-	-
Net Profit before Tax		1,908.63	2,400.15	1,439.80	1,037.31
Less: Tax expense					
(a) Current Tax		480.25	700.00	383.00	265.00
(b) Deferred Tax		3.20	(26.49)	4.65	(0.94)
(c) Short/Excess Tax provision for earlier period		20.57	17.85	38.55	(0.07)
Total Tax expense		504.02	691.37	426.20	263.99
Net Profit / (Loss) for the period		1,404.61	1,708.78	1,013.60	773.32
Earning Per Share:					
- Basic		7.21*	9.21	7.10	5.42
- Diluted		7.21*	9.21	7.10	5.42

* not annualised

The above statement should be read with Basis of Preparation and the Significant Accounting Policies appearing in Annexure IV, Notes to the Restated Financial Information appearing in Annexure V & Adjustments to Audited Financial Statements appearing in Annexure VI.

As per our report of even date attached

For and on behalf of
V. N. PUROHIT & CO.
Chartered Accountants
FRN:304040E

For and on behalf of board of directors
CFF FLUID CONTROL LIMITED
CIN: U28990MH2012PLC227023

Sd/-
O.P. Pareek
Partner
Membership No: 014238
Date : 7th November 2024
Place : New Delhi
UDIN : 24014238BKAUHU4281

Sd/-
Gautam Makkar
Director
DIN: 00354956
Date : 7th November 2024
Place: Mumbai

Sd/-
Sunil Menon
Director
DIN: 00409485
Date : 7th November 2024
Place: Mumbai

Sd/-
Sonika Mehta
Company Secretary
Membership No: A63323
Date : 7th November 2024
Place: Mumbai

Sd/-
Hitesh Birla
Chief Financial Officer
PAN: AOCPB7046K
Date : 7th November 2024
Place: Mumbai

CFF FLUID CONTROL LIMITED
CIN: U28990MH2012PLC227023

Annexure III - Restated Financial Statement of Cash Flows

Rupees in Lakhs, unless otherwise Stated

Particulars	Period ended September 30, 2024	Year ended March 31, 2024	Year ended March 31, 2023	Year ended March 31, 2022
Cash flow from operating activities				
Net profit before tax	1,908.63	2,400.15	1,439.80	1,037.31
Adjustments for :				
Depreciation	289.41	445.26	131.95	90.79
Provision for Gratuity	17.84	4.33	2.95	8.39
Foreign Exchange fluctuation (Gain)/ Loss	(7.64)	6.66	(35.33)	2.10
Interest income	(10.77)	(11.66)	(7.98)	(10.45)
Balance written off	-	-	-	(3.18)
Finance cost	105.92	239.97	311.07	124.83
Operating profit before working capital adjustment	2,303.39	3,084.70	1,842.45	1,249.79
Adjustment for changes in working capital				
Increase/(decrease) Trade and other payable	863.16	(696.96)	(983.33)	1,358.50
Increase/(decrease) Other current liabilities	(14.65)	(12.93)	234.12	(410.57)
Increase/(decrease) in short term provision	-	(8.50)	-	-
(Increase)/decrease Other Short term Loans & Advances	1,109.95	(2,452.78)	(5.42)	(592.83)
(Increase)/decrease Trade and other receivables	(4,327.70)	(68.99)	501.08	(654.28)
(Increase)/decrease in inventories	(527.96)	(1,540.40)	(1,644.43)	(78.33)
(Increase)/decrease Other current assets	(0.54)	(336.89)	(534.89)	97.65
(Increase)/decrease Other current and non current assets	(31.93)	(27.04)	(25.18)	(20.50)
Cash flow generated from operations	(626.29)	(2,059.78)	(615.59)	949.42
Direct taxes paid	(51.88)	(615.59)	(311.61)	(29.74)
Net cash flow from/(used in) operating activities (A)	(678.18)	(2,675.37)	(927.20)	919.69
Cash flow from investing activities				
Purchases of fixed assets(including intangible asset)	(185.39)	(1,671.19)	(1,947.44)	-
Intangible asset	-	-	-	-
Interest received	10.77	11.66	7.98	10.45
Purchase of building and plant and machinery	-	-	-	-
Net Cash flow from/(used in) Investing activities (B)	(174.63)	(1,659.53)	(1,939.46)	10.45
Cash flow from financing activities				
Proceed from short term borrowings	(290.07)	144.73	1,009.42	(688.88)
Proceed from long term borrowings	(61.69)	(2,386.35)	1,920.93	86.84
Finance cost	(105.92)	(239.97)	(311.07)	(124.83)
Issue of share capital	-	8,483.28	-	-
Dividend	-	(97.37)	-	-
Net cash flow from/(used in) financing activities (C)	(457.68)	5,904.32	2,619.28	(726.87)
Increase/(Decrease) in cash and cash equivalents (A+B+C)	(1,310.49)	1,569.42	(247.37)	203.27
Cash and cash equivalent at the beginning of the year	1,727.32	157.91	405.28	202.01
Cash & cash equivalent at the end of the year (note 16)	416.83	1,727.33	157.91	405.28

1 The Restated Statement of Cash Flows has been prepared under the indirect method as set out in AS 3, Statement of Cash Flows.

2. Figures in brackets represent outflow of cash and cash equivalents.

3. The above statement should be read with Basis of Preparation and the Significant Accounting Policies appearing in Annexure IV, Notes to the Restated Financial Information appearing in Annexure V & Adjustments to Audited Financial Statements appearing in Annexure VI.

As per our report of even date attached

For and on behalf of
V. N. PUROHIT & CO.
Chartered Accountants
FRN:304040E

For and on behalf of board of directors
CFF FLUID CONTROL LIMITED
CIN: U28990MH2012PLC227023

O.P. Pareek
Partner
Membership No: 014238
Date : 7th November 2024
Place : New Delhi
UDIN : 24014238BKAUHU4281

Sd/-
Gautam Makkar
Director
DIN: 00354956
Date : 7th November 2024
Place: Mumbai

Sd/-
Sunil Menon
Director
DIN: 00409485
Date : 7th November 2024
Place: Mumbai

Sd/-
Sonika Mehta
Company Secretary
Membership No: A63323
Date : 7th November 2024
Place: Mumbai

Sd/-
Hitesh Birla
Chief Financial Officer
PAN: AOCPB7046K
Date : 7th November 2024
Place: Mumbai

Annexure IV- Basis of preparation and Significant Accounting Policies

Significant accounting policies

1 Company Overview

M/s CFF Fluid Control Pvt Ltd. Company incorporated on 16th February 2012, having its registered office at Plot No 1, Survey No-96, Kumbhivli Madap Khopoli In, Khalapur, Raigad, Maharashtra. Directors of the company are Mr. Gautam Makkar & Mr Sunil Menon. The nature of the operations and principal activities of the company is engaged in the business of manufacture, overhaul, repairs and maintenance of shipboard machinery, combat systems, reference systems, test facilities(pneumatic, hydraulic, electrical, electronic systems) for submarines & surface ships for Indian navy.

2 Basis of preparation and presentation of Restated Financial Statements

These financial statements have been prepared in accordance with generally accepted accounting principles ('GAAP') in India under the historical cost convention on the accrual basis of accounting. These financial statements have been prepared to comply in all material aspects with the accounting standards specified under section 133 of the Companies Act, 2013 read with Rule 7 of the Companies (Accounts) Rules, 2014 and other relevant provisions of the Companies Act, 2013 (hereinafter together referred to as 'the Act') and Schedule III of the Act.

The restated financial information has been prepared for inclusion in the Draft Offer Document to be filed by the Company with the BSE- SME in connection with proposed Further Public Offering of its equity shares of face value of Rs 10 each of the Company comprising a fresh issue of equity shares (the "Offer"), in accordance with the requirements of:

- Section 26 of part I of Chapter III of the Act
- relevant provisions of the Securities and Exchange Board of India (Issue of Capital and Disclosure Requirements Regulations, 2018, issued by the Securities and Exchange Board of India ('SEBI') as amended in pursuance of the Securities and Exchange Board of India Act, 1992; and
- Guidance Note on Reports in Company Prospectuses (Revised 2019) issued by the Institute of Chartered Accountants of India ("ICAI").

The Restated financial information have been compiled from:

- the audited financial statement of the Company as at September 30, 2024 which have been approved by the Board of Directors at their meeting held on 7th November 2024
- the audited financial statement of the Company as at March 31, 2024 which have been approved by the Board of Directors at their meeting held on May 29, 2024.
- the audited financial statement of the Company as at March 31, 2023 which have been approved by the Board of Directors at their meeting held on July 31, 2023.
- the audited financial statement of the Company as at March 31, 2022 which have been approved by the Board of Directors at their meeting held on September 15, 2022.

There were no qualifications in the Audit Reports issued by Statutory Auditor(s) for the period ended on September 30, 2024, March 31, 2024, March 31, 2023 and March 31, 2022.

The accounting policies adopted in the preparation of financial statements are consistent with those of previous year.

2.1 Significant accounting policies

a) Use of estimates

The preparation of the financial statements in conformity with generally accepted accounting principles in India requires management to make estimates and assumptions that affect the reported amounts of assets and liabilities and disclosure of contingent assets and liabilities at the date of the financial statements, and the reported amounts of revenues and expenses during the reporting period. The Company's most significant estimates include those on the useful life of assets, deferred taxes and provision for taxes. Management believes that the estimates used in the preparation of the financial statements are prudent and reasonable. Actual results could differ from these estimates. Appropriate changes in estimates are made as management becomes aware of changes in circumstances surrounding the estimates.

b) Current-non-current classification

Assets

An asset is classified as current when it satisfies any of the following criteria:

- it is expected to be realised in, or is intended for sale or consumption in, the company's normal operating cycle;
- it is held primarily for the purposes of being traded;
- it is expected to be realised within 12 months after the reporting date; or
- it is cash or cash equivalent unless it is restricted from being exchanged or used to settle a liability for at least 12 months after the reporting date.

Current assets include the current portion of non-current financial assets. All other assets are classified as non-current.

Liabilities

A liability is classified as current when it satisfies any of the following criteria:

- it is expected to be settled in the company's normal operating cycle;
- it is held primarily for the purposes of being traded;
- it is due to be settled within 12 months after the reporting date; or
- the company does not have an unconditional right to defer settlement of the liability for at least 12 months after the reporting date.

Current liabilities include the current portion of non-current financial liabilities.

All other liabilities are classified as non-current.

c) Property, plant and equipment and Intangible Assets

Property, plant and equipment are stated at cost less accumulated depreciation. Cost includes all incidental costs related to acquisition and installation, other pre-operative costs and interest on borrowed funds, if any, used to finance the acquisitions of fixed assets and is capitalized up to the date the assets are ready for commercial use.

Depreciation is provided over the estimated useful life of the assets using written down value method. The rates of depreciation used are those which have been calculated as per the method specified in Schedule II of the Companies Act, 2013. The new Companies Act prescribes that the asset should be written off over its useful life as estimated by the management and provides the indicative useful lives for the different class of assets. Other assets are depreciated over their balance useful life.

Type of Assets	Period
Buildings	30 Years
Plant and Machinery	15 Years
Furniture and Fixtures	10 Years
Vehicles	10 Years
Office equipment	5 Years
Computers & Electronics	3 Years
Intangible Assets	5 Years

d) Impairment of assets

The carrying values of assets / cash generating units at each balance sheet date are reviewed for impairment if any indication of impairment exists.

If the carrying amount of the assets exceed the estimated recoverable amount, an impairment is recognized for such excess amount. The impairment loss is recognized as an expense in the statement of profit and loss, unless the asset is carried at revalued amount, in which case any impairment loss of the revalued asset is treated as a revaluation decrease to the extent a revaluation reserve is available for that asset.

When there is indication that an impairment loss recognized for an asset (other than a revalued asset) in earlier accounting periods no longer exists or may have decreased, such reversal of impairment loss is recognized in the Statement of Profit and Loss, to the extent the amount was previously charged to the Statement of Profit and Loss. In case of revalued assets such reversal is not recognized.

e) Investments

Investments, which are readily realizable and intended to be held for not more than one year from the date on which such investments are made, are classified as current investments. All other investments are classified as long-term investments.

On initial recognition, all investments are measured at cost. The cost comprises purchase price and directly attributable acquisition charges such as brokerage, fees and duties. If an investment is acquired, or partly acquired, by the issue of shares or other securities, the acquisition cost is the fair value of the securities issued. If an investment is acquired in exchange for another asset, the acquisition is determined by reference to the fair value of the asset given up or by reference to the fair value of the investment acquired, whichever is more clearly evident.

Long-term investments are carried at cost. However, provision for diminution in value is made to recognize a decline other than temporary in the value of the investments.

On disposal of an investment, the difference between its carrying amount and net disposal proceeds is charged or credited to the statement of profit and loss.

f) Inventories

Inventory consists of Raw materials and spares is valued at cost. Cost of inventories comprises of all cost of purchases and other costs incurred in bringing the inventory to their present location and condition. Cost is assigned on First-In-First-Out (FIFO) basis. Obsolete, defective and unserviceable stocks are provided for, wherever required.

g) Cash and cash equivalents

Cash equivalents represent highly liquid investments with remaining maturities, at the date of purchase/investment, of three months or less. As of the balance sheet date, the Company had no such investment. Cash and cash equivalents comprise of cash in hand and balance in bank accounts.

h) Revenue recognition

Revenue from sale of goods is recognised at the time of delivery of goods. Service revenue is recognised after performance of the service contract is completed. Recognition of revenue is based upon the condition that there is no significant uncertainty exist regarding the amount of consideration that will be derived from sale or services. Revenue is reported net of trade discounts, if any.

i) Other operational revenue

Other operational revenue represent income earned from the activities incidental to the business and is recognized when the right to receive the income is established as per the terms of the contract.

j) Interest

Interest income is recognized on a time proportion basis by considering the amount outstanding and rate applicable.

h) Retirement and employee benefits

Contributions to secure retiral benefits in respect of provident fund, based on applicable rules/status, are charges to revenue.

i) Borrowing cost

As per AS 16, borrowing costs directly attributable to the acquisition, construction or production of qualifying assets, which are assets that necessarily take a substantial period of time to get ready for their intended use or sale, are added to the cost of those assets, until such time as the assets are substantially ready for their intended use or sale.

j) Income taxes

Tax expense comprises current tax (i.e. amount of tax for the period determined in accordance with the Income Tax Act, 1961), deferred tax charge or benefit (reflecting the tax effect of timing differences between accounting income and taxable income for the period) and minimum alternate tax.

Current tax

Current tax is recognized based on estimated tax liability computed after adjusting for allowances, disallowances and exemptions in accordance with the Income Tax Act, 1961.

Deferred tax

Deferred tax is provided on timing differences between taxable income and accounting income subject to consideration of prudence. Deferred tax assets and liabilities are measured using the tax rates and tax law that have been enacted or substantively enacted by the balance sheet date. Deferred tax assets are reviewed as at each balance sheet date and written down or written up to reflect the amount that is reasonably/virtually certain to be realized.

k) Earnings per share

The Company reports basic earnings per share (EPS) in accordance with Accounting Standard - 20. The basic earnings per share is computed by dividing the net profit/loss attributable to equity shareholders for the year by the weighted average number of equity shares outstanding during the year. The Company has no potentially dilutive equity shares outstanding during the period.

l) Provisions and contingent liabilities

The Company recognizes a provision when there is a present obligation arising from a past event that probably requires an outflow of resources and a reliable estimate can be made of the amount of the obligation. A disclosure for a contingent liability is made when there is a possible obligation or a present obligation that may, but probably will not, require an outflow of resources. Where there is a possible obligation or a present obligation that the likelihood of outflow of resources is remote, no provision or disclosure is made.

m) Foreign currency transactions

Income and expense in foreign currencies are converted at exchange rates prevailing on the date of the transaction. Foreign currency monetary assets and liabilities other than net investments in non-integral foreign operations are translated at the exchange rate prevailing on the balance sheet date and exchange gains and losses are recognised in the statement of profit and loss. Exchange difference arising on a monetary item that, in substance, forms part of an enterprise's net investments in a non-integral foreign operation are accumulated in a foreign currency translation reserve

n) Segment Reporting

The Company operates in a single primary business segment . Hence, there are no reportable segment as per AS 17 Segment Reporting.

3 Equity share capital

(a) Particulars	As at September 30, 2024	As at March 31, 2024	As at March 31, 2023	As at March 31, 2022
Authorised share capital*				
2,10,00,000 equity shares of Rs 10 each	2,100.00	2,100.00	2,100.00	100.00
Total	2,100.00	2,100.00	2,100.00	100.00
Issued subscribed & paid up share capital				
Share capital at the beginning of the year	1,947.41	1,427.41	71.37	71.37
Shares Issued during the period	-	520.00	1,356.04	-
Total	1,947.41	1,947.41	1,427.41	71.37

Note :

a. The Company has increased its authorized share capital from 10 lakh shares to 200 lakhs shares at the Board Meeting held on 11th June,2022 and further increased it to 210 lakh shares at the Board Meeting held on 21st November, 2022.

b. In the event of liquidation of the company, the holders of equity shares will be entitled to receive any of the remaining assets of the company, after distribution of all preferential amounts. The distribution will be in proportion to the number of equity shares held at the time of commencement of winding-up.

c. The Shareholders have all other rights as available to equity shareholders as per the provisions of The Companies Act, 2013, read together with the Memorandum of Association and Articles of Association of the Company, as applicable.

(b) The reconciliation of the numbers of shares outstanding and amount of share capital as at year end is set out below:

Particulars	As at September 30, 2024	As at March 31, 2024	As at March 31, 2023	As at March 31, 2022
Equity Shares (in nos)				
Shares outstanding at the beginning of the year	19,474,100	14,274,100	713,705	713,705
Shares issued during the period	-	5,200,000	13,560,395	-
Shares Outstanding at the end of the period	19,474,100	19,474,100	14,274,100	713,705
Equity Share Capital (in lakhs)				
Share Capital outstanding at the beginning of the year	1,947.41	1,427.41	71.37	71.37
Share Capital issued during the year	-	520.00	1,356.04	-
Equity Shares Capital at the end of the period	1,947.41	1,947.41	1,427.41	71.37

(c) Name of Equity Shareholders holding more than 5% equity shares

Name of shareholders	No. of Shares held	% of Holding	% Change during the Year
Sunil Menon			
September 30, 2024	7,138,260	36.66%	0.00%
March 31, 2024	7,138,260	36.66%	-13.34%
March 31, 2023	7,136,660	50.00%	0.00%
March 31, 2022	356,833	50.00%	0.00%
Gautam Makkar			
September 30, 2024	4,356,340	22.37%	0.00%
March 31, 2024	4,356,340	22.37%	-8.15%
March 31, 2023	4,356,340	30.52%	0.00%
March 31, 2022	217,817	30.52%	0.00%
Niranjana Makker			
September 30, 2024	1,016,740	5.22%	0.00%
March 31, 2024	1,016,740	5.22%	-1.90%
March 31, 2023	1,016,740	7.12%	0.00%
March 31, 2022	50,837	7.12%	0.00%
Mrs. Sheela Makker			
September 30, 2024	1,763,560	9.06%	0.00%
March 31, 2024	1,763,560	9.06%	-3.30%
March 31, 2023	1,763,560	12.35%	0.00%
March 31, 2022	88,178	12.35%	0.00%

(d) Shares held by promoters at the year end

Name of Promoter	Number of shares	% Change
Sunil Menon		
September 30, 2024	7,138,260	0.00%
March 31, 2024	7,138,260	-13.34%
March 31, 2023	7,136,660	0.00%
March 31, 2022	356,833	0.00%
Gautam Makkar		
September 30, 2024	4,356,340	0.00%
March 31, 2024	4,356,340	-8.15%
March 31, 2023	4,356,340	0.00%
March 31, 2022	217,817	0.00%

(e) Rights, preferences and restrictions attached to equity shares

The Company has a single class of equity shares. Accordingly, all equity shares rank equally with regard to dividends and share in the Company's residual assets. Equity shares are entitled to receive dividend as declared from time to time. The voting rights of an equity shareholder are in proportion to its share of the paid-up equity capital of the Company.

(i) On 5th June 2023, the Company has issued and allotted 52,00,000 equity shares having face value of Rs. 10 each by way of Initial Public Offer at an issue price of Rs. 165 per equity share.

(ii) On 11th July 2022, the Company has issued and allotted 1,35,60,395 equity shares having face value of Rs. 10 each by way of Bonus Shares in ratio of 19:1 to the existing shareholders.

4 Reserves and Surplus

Particulars	As at September 30, 2024	As at March 31, 2024	As at March 31, 2023	As at March 31, 2022
Retained Earnings				
Opening balance	2,682.93	1,071.52	1,135.24	361.92
Profit during the year	1,404.61	1,708.78	1,013.60	773.32
Less: Dividend	97.37	97.37	-	-
Less: Bonus Shares issued during the year (Refer note a)	-	-	1,077.32	-
Closing balance (A)	3,990.16	2,682.93	1,071.52	1,135.24
Security premium				
Opening balance	7,963.28	-	278.72	278.72
Issue of shares through IPO (Refer note b)	-	8,060.00	-	-
Less: Adjustment towards issue expenses (Refer note c)	-	96.72	-	-
Less: Bonus Shares issued during the year	-	-	278.72	-
Closing balance (B)	7,963.28	7,963.28	-	278.72
Total (A+B)	11,953.45	10,646.21	1,071.52	1,413.96

Note a: In relation to financial year ending on 31st March 2024, the Company had declared a final dividend of Re. 1.00 per equity share (including interim dividend of Rs. 0.50 per equity share) in its Annual General Meeting held on 30th September 2024.

Note b: On 5th June 2023, the Company has issued and allotted 52,00,000 equity shares having face value of Rs. 10 each by way of Initial Public Offer at an issue price of Rs. 165 per equity share.

Note c: During F.Y 2023-24, the Company has incurred expenses towards public issue amounting to Rs. 96.72 lakhs which were adjusted from securities premium as per provisions of Section 52 of the Companies Act, 2013.

5 Long term borrowings

Particulars	As at September 30, 2024	As at March 31, 2024	As at March 31, 2023	As at March 31, 2022
(Secured Loans)				
Term loan	545.39	639.06	871.17	314.27
Secured Long term maturities of Car Loans	31.97	-	-	-
Total	577.36	639.06	871.17	314.27
(Unsecured)				
Inter corporate borrowing	-	-	2,154.24	790.21
	-	-	2,154.24	790.21
Total	577.36	639.06	3,025.41	1,104.48

Above secured loans includes interest accrued and not due.

5a Terms of repayment for secured loans

Particulars	Amount borrowed	Tenor (Months)	Outstanding as on Sept 30, 2024	Repayable amount monthly
Guaranteed emergency credit line 1-Axis Bank	142.00	60	114.39	3.94
Term Loan-Axis Bank	700.00	60	618.34	11.66
Vehicle Loan-HDFC Bank	21.98	60	21.40	0.46
Vehicle Loan- Kotak Mahindra Bank	17.44	60	16.64	0.36

5b Details of Security :

i. Primary Security : Extension of hypothecation on the entire current assets of the Company both present & future. First and exclusive hypothecation charge on machineries financed out by the bank.

ii. Collateral security : Extension of Equitable Mortgage of the following properties: a)Industrial Property situated at plot no.1, Survey no. 96, Village Kumbhivali, Taluka Khalapur, Dist. Raigad, owned by Company. b) EM/RM of Residential Flat No B-2202, Adonia, Hiranandani Gardens, Powai owned by Company.

iii. Guarantee Personal guarantee of Directors Gautam Makkar and Sunil Menon

Terms of repayment for unsecured loans

During previous years, Unsecured loan from Corporates (promoter's group company) were borrowed at 12% interest cost.

6 Long term provisions

Particulars	As at September 30, 2024	As at March 31, 2024	As at March 31, 2023	As at March 31, 2022
Gratuity provision	31.49	14.70	10.52	7.69
Total	31.49	14.70	10.52	7.69

7 Short term borrowings

Particulars	As at September 30, 2024	As at March 31, 2024	As at March 31, 2023	As at March 31, 2022
Secured				
- Current maturities of long term debts	187.33	218.33	100.89	151.82
Cash credit facilities from Bank	1,231.43	1,490.51	1,463.22	402.87
Total	1,418.77	1,708.84	1,564.11	554.69

Terms of Working capital demand facility:

Cash Credit limit of 1,500.00 lakhs is sanctioned from Axis Bank and details of security is same as given in Note 5b.

8 Trade payables

Particulars	As at September 30, 2024	As at March 31, 2024	As at March 31, 2023	As at March 31, 2022
- Total outstanding dues of micro enterprises and small enterprises (Refer note below)	-	-	-	-
- Total outstanding dues other than micro enterprises and small enterprises	1,099.14	243.62	933.91	1,961.07
Total	1,099.14	243.62	933.91	1,961.07

There are no dues to micro enterprises and small enterprises as defined under Micro, Small & Medium Enterprises Development Act, 2006 which are outstanding for a period more than 45 days as on Balance Sheet Date.

Ageing of Trade Payables

Particulars	As at September 30, 2024	As at March 31, 2024	As at March 31, 2023	As at March 31, 2022
(I)micro enterprises and small enterprises	-	-	-	-
(II) Total outstanding dues of creditors other than micro enterprises and small enterprises Outstanding for following periods from due date of payment				
Less than 1 year	1,099.14	243.62	756.15	1,666.54
1-2 years	-	-	172.47	287.86
2-3 years	-	-	-	2.70
More than 3 years	-	-	5.29	3.97
Total	1,099.14	243.62	933.91	1,961.07
(III)Disputed Dues MSME	-	-	-	-
(IV)Disputed Dues-Others	-	-	-	-

9 Other current liabilities				
Particulars	As at September 30, 2024	As at March 31, 2024	As at March 31, 2023	As at March 31, 2022
Unpaid Dividend	0.04	0.04	-	-
Current maturities of finance lease obligations	6.07	-	-	-
Audit Fees payable	1.35	3.24	2.70	3.30
Statutory Dues Payable	70.61	42.82	69.58	20.58
Dividend Payable	97.37	-	-	-
Advance from customers	24.27	184.50	103.26	6.67
Other Payables	-	-	198.64	198.64
Other Expenses Payable	341.65	228.05	97.40	8.27
Total	541.36	458.65	471.57	237.45

10 Short term provisions				
Particulars	As at September 30, 2024	As at March 31, 2024	As at March 31, 2023	As at March 31, 2022
Provision for Gratuity	2.01	0.96	0.82	0.70
CSR Expenses	-	-	8.50	-
Provision for income tax	905.44	456.50	354.24	244.29
Total	907.45	457.46	363.56	244.99

12 Deferred tax Asset/ (liabilities)				
Particulars	As at September 30, 2024	As at March 31, 2024	As at March 31, 2023	As at March 31, 2022
Asset/ (liabilities) at the start of the year	29.49	3.00	7.65	6.71
Credit/ (charge) to the statement of profit & loss	(3.20)	26.49	(4.65)	0.94
Asset/ (liabilities) at the end of the year	26.29	29.49	3.00	7.65

13 Other non current assets				
Particulars	As at September 30, 2024	As at March 31, 2024	As at March 31, 2023	As at March 31, 2022
Security deposits	58.12	26.19	44.51	19.32
Earnest money deposit- Tender Fees	30.00	30.00	1.18	1.18
Total	88.12	56.19	45.68	20.50

14 Inventories				
Particulars	As at September 30, 2024	As at March 31, 2024	As at March 31, 2023	As at March 31, 2022
Raw materials	5,796.14	5,268.18	3,727.78	2,083.36
Total	5,796.14	5,268.18	3,727.78	2,083.36

15 Trade receivables				
Particulars	As at September 30, 2024	As at March 31, 2024	As at March 31, 2023	As at March 31, 2022
Unsecured, Considered good	5,210.00	882.30	813.31	1,314.39
Total	5,210.00	882.30	813.31	1,314.39

Ageing for Trade receivables				
Particulars	As at September 30, 2024	As at March 31, 2024	As at March 31, 2023	As at March 31, 2022
(i) Undisputed Trade receivables – considered good	-	-	-	-
Outstanding for following periods from due date of payment				
Less than 6months	5,210.00	882.30	813.31	1,314.39
6 months to 1year	-	-	-	-
1-2 years	-	-	-	-
2-3 years	-	-	-	-
More than 3 years	-	-	-	-
Total	5,210.00	882.30	813.31	1,314.39

16 Cash and bank balances				
Particulars	As at September 30, 2024	As at March 31, 2024	As at March 31, 2023	As at March 31, 2022
Balances with banks :				
- Current accounts	164.54	1,530.24	5.68	230.81
- In fixed deposits- more than 12 months (Note 16.1)	243.91	189.06	143.70	169.47
Cash in hand	8.38	8.02	8.53	5.00
Total	416.83	1,727.32	157.91	405.28
16.1 Deposits held as margin money against guarantee	243.91	189.06	143.70	169.47

17 Short term loans & advances				
Particulars	As at September 30, 2024	As at March 31, 2024	As at March 31, 2023	As at March 31, 2022
(Unsecured , Considered Good)				
Advances to employees & Others	9.51	7.86	15.17	4.10
Advances to related parties	-	-	-	2.72
Advances to suppliers	2,168.20	3,279.80	819.72	822.64
Total	2,177.71	3,287.66	834.88	829.46

18 Other current assets				
Particulars	As at September 30, 2024	As at March 31, 2024	As at March 31, 2023	As at March 31, 2022
Retention Money and other Deposits	36.46	369.46	324.14	102.84
Prepaid Expenses	24.40	-	37.02	-
Balance with government authorities	933.61	624.47	295.88	19.32
Total	994.47	993.93	657.05	122.16

Annexure V - Restated Financial Information

Rupees in Lakhs, unless otherwise Stated

11 Property, plant and equipment and Intangible Assets

Particulars	Tangible Assets							Intangible Assets		
	Land	Building	Plant and machinery	Office equipment	Furniture and fixtures	Computer	Vehicles	Total Tangible Assets	Design Software	TWA Technology
Gross carrying amount										
As at April 01, 2024	219.74	1,499.99	2,305.82	34.89	126.64	11.75	0.89	4,199.72	4.85	-
Additions	-	-	1.90	0.92	-	-	49.50	52.33	0.68	981.72
Disposals	-	-	-	-	-	-	-	-	-	-
As at September 30, 2024	219.74	1,499.99	2,307.72	35.81	126.64	11.75	50.39	4,252.04	5.53	981.72
Accumulated depreciation										
As at April 01, 2023	-	407.56	700.17	31.61	33.06	10.35	0.27	1,183.02	0.01	-
Charge for the year	-	51.89	145.37	0.41	12.11	0.37	3.42	213.56	1.64	74.21
On disposals	-	-	-	-	-	-	-	-	-	-
As at September 30, 2024	-	459.45	845.54	32.02	45.18	10.72	3.69	1,396.58	1.65	74.21
Net carrying amount as at September 30, 2024	219.74	1,040.55	1,462.17	3.80	81.46	1.03	46.71	2,855.46	3.88	907.51
Gross carrying amount										
As at April 01, 2023	219.74	1,493.57	1,582.67	34.26	23.29	11.75	0.89	3,366.17	-	-
Additions	-	6.43	723.14	0.63	103.35	-	-	833.55	4.85	-
Disposals	-	-	-	-	-	-	-	-	-	-
As at March 31, 2024	219.74	1,499.99	2,305.82	34.89	126.64	11.75	0.89	4,199.72	4.85	-
Accumulated depreciation										
As at April 01, 2023	-	292.96	387.06	30.56	18.80	8.35	0.05	737.77	-	-
Charge for the year	-	114.60	313.12	1.06	14.27	1.99	0.22	445.25	0.01	-
On disposals	-	-	-	-	-	-	-	-	-	-
As at March 31, 2024	-	407.56	700.17	31.61	33.06	10.35	0.27	1,183.02	0.01	-
Net carrying amount as at March 31, 2024	219.74	1,092.44	1,605.64	3.28	93.57	1.40	0.63	3,016.70	4.84	-
Gross carrying amount										
As at April 01, 2022	219.74	569.79	566.45	32.04	23.29	7.41	-	1,418.73	-	-
Additions	-	923.78	1,016.22	2.22	103.35	4.34	0.89	1,947.44	-	-
Disposals	-	-	-	-	-	-	-	-	-	-
As at March 31, 2023	219.74	1,493.57	1,582.67	34.26	23.29	11.75	0.89	3,366.17	-	-
Accumulated depreciation										
As at April 01, 2022	-	207.58	343.79	30.05	17.23	7.17	-	605.82	-	-
Charge for the year	-	85.38	43.27	0.50	1.57	1.18	0.05	131.95	-	-
On disposals	-	-	-	-	-	-	-	-	-	-
As at March 31, 2023	-	292.96	387.06	30.56	18.80	8.35	0.05	737.77	-	-
Net carrying amount as at March 31, 2023	219.74	1,200.61	1,195.62	3.70	4.49	3.40	0.85	2,628.39	-	-
Gross carrying amount										
As at April 01, 2021	219.74	569.79	566.45	32.04	23.29	7.41	-	1,418.73	-	-
Additions	-	-	-	-	-	-	-	-	-	-
Disposals	-	-	-	-	-	-	-	-	-	-
As at March 31, 2022	219.74	569.79	566.45	32.04	23.29	7.41	-	1,418.73	-	-
Accumulated depreciation										
As at April 01, 2021	-	169.56	294.58	28.61	15.11	7.17	-	515.03	-	-
Charge for the year	-	38.02	49.21	1.45	2.12	-	-	90.79	-	-
On disposals	-	-	-	-	-	-	-	-	-	-
As at March 31, 2022	-	207.58	343.79	30.05	17.23	7.17	-	605.82	-	-
Net carrying amount as at March 31, 2022	219.74	362.21	222.66	1.99	6.06	0.24	-	812.91	-	-

Immovable properties are in the name of the Company.

Intangible asset under development

Particulars	30-Sep-24	31-Mar-24	31-Mar-23	31-Mar-22
Opening Balance	849.33	-	-	-
Add : Addition during the year	132.39	849.33	-	-
Less : Capitalisation during the year	(981.72)	-	-	-
Closing Balance	-	849.33	-	-

The Company pursuant to Technology Transfer Agreement has incurred a sum of Rs. 849.33 lakhs during the year towards "Towed Wired Antenna" (TWA) technology from NEREIDES, France who is engaged in manufacturing TWA and will transfer its technology, process, knowhow and product development to the Company.

Intangible asset under development ageing schedule

Project in process

Amount in CWIP for a period	30.09.2024	31.03.2024	31.03.2023	31.03.2022
Less than 1 years	-	849.33	-	-
1-2 years	-	-	-	-
2-3 years	-	-	-	-
More than 3years	-	-	-	-
Total	-	849.33	-	-

19 Revenue from operations

Particulars	Period ended	Year ended	Year ended	Year ended
	September 30, 2024	March 31, 2024	March 31, 2023	March 31, 2022
Sale of products	6,308.26	10,120.54	6,825.47	4,279.95
Sale of Service	1,695.14	565.37	241.16	418.82
Total(Net)	8,003.41	10,685.91	7,066.63	4,698.77

20 Other income

Particulars	Period ended	Year ended	Year ended	Year ended
	September 30, 2024	March 31, 2024	March 31, 2023	March 31, 2022
Interest on FD	10.77	11.66	7.98	10.45
Foreign Fluctuation	7.64	-	35.33	-
Sundry Balance written off	-	-	-	3.18
Total	18.40	11.66	43.31	13.62

21 Cost of material consumed

Particulars	Period ended	Year ended	Year ended	Year ended
	September 30, 2024	March 31, 2024	March 31, 2023	March 31, 2022
Raw materials				
Opening Stock of raw materials	5,268.18	3,727.78	2,083.36	2,005.03
Add: Purchase of materials	4,286.49	7,011.92	6,078.70	3,191.80
Less: Closing stock of raw materials	5,796.14	5,268.18	3,727.78	2,083.36
Total	3,758.53	5,471.52	4,434.27	3,113.47
Other direct expenses				
Factory Expenses	2.33	2.74	0.06	0.48
Labour Charges	38.14	59.73	66.51	2.41
Job Charges	-	0.60	65.55	26.10
Electricity Expenses	34.77	48.62	36.41	48.87
Packing Expenses	0.18	-	0.06	0.00
Testing Charges	2.27	2.70	5.60	4.30
O & M Charges	927.74	792.05	-	-
Repair & Maintenance	7.41	3.15	-	-
Transportation	11.49	15.98	14.12	1.47
Total direct expenses	1,024.33	925.57	199.03	83.73
Total	4,782.86	6,397.09	4,633.30	3,197.20

22 Employee benefit expenses

Particulars	Period ended	Year ended	Year ended	Year ended
	September 30, 2024	March 31, 2024	March 31, 2023	March 31, 2022
Salaries and bonus expenses	404.05	309.71	200.11	91.68
Director Remuneration	42.00	84.00	42.00	-
Contribution to EPF	16.85	12.70	3.62	1.80
Contribution to ESI	0.91	0.27	0.25	0.19
Gratuity (Note 31.2)	17.84	4.33	2.95	1.76
Employee welfare expense incl insurance	10.26	2.79	2.13	0.92
Total	491.91	413.80	251.06	96.35

23 Finance cost

Particulars	Period ended	Year ended	Year ended	Year ended
	September 30, 2024	March 31, 2024	March 31, 2023	March 31, 2022
Bank Interest	89.69	156.54	88.42	115.35
Interest on Unsecured Loan	-	57.57	185.86	-
BG Commission	13.62	18.18	36.79	9.48
Loan Processing Charges	2.61	7.69	-	-
Total	105.92	239.97	311.07	124.83

24 Depreciation expenses

Particulars	Period ended	Year ended	Year ended	Year ended
	September 30, 2024	March 31, 2024	March 31, 2023	March 31, 2022
Depreciation on property plant and equipment (Refer note 11)	289.41	445.26	131.95	90.79
Total	289.41	445.26	131.95	90.79

25 Other expenses

Particulars	Period ended	Year ended	Year ended	Year ended
	September 30, 2024	March 31, 2024	March 31, 2023	March 31, 2022
Payment to statutory auditors (Refer note below)	1.50	3.00	7.00	3.00
Internal audit fees	0.75	1.50	-	-
Bank Charges	2.53	2.23	1.79	1.21
Legal & professional expenses	259.65	537.75	43.71	28.61
Commission expenses	4.87	-	0.07	2.10
Filing fees	1.46	0.98	24.94	0.26
Directors' sitting fees	0.80	4.25	-	-
Annual Listing Fee	0.36	0.40	-	-
Late Delivery charges	2.58	31.02	131.61	79.75
Rent	45.82	90.44	68.62	14.73
Tender fees	15.38	18.11	-	-
CSR Fund	8.50	17.00	8.50	-
Donation	0.35	11.00	0.50	-
Insurance expense	4.22	4.98	2.56	2.08
Inspection Charges	-	1.12	2.43	0.03
Late fees/ Interest on Statutory Duty	2.11	1.79	1.93	11.49
Interest on delayed payments	8.86	1.54	-	0.34
Business promotion	4.34	2.25	-	-
Repair & Maintenance	1.38	-	-	-
Foreign Fluctuation Expenses	-	6.66	-	2.10
Postage & Courier	0.53	0.99	1.73	2.41
Stamp Duty expenses	11.54	2.16	25.11	-
Printing & stationery expense	3.28	2.84	0.77	-
Electricity Expenses for office	4.98	-	-	-
Miscellaneous expense	4.44	9.84	4.08	0.90
Rates & Taxes	-	2.20	-	-
Security expense	4.47	7.71	3.84	2.36
Telephone & internet charges	1.41	1.86	1.86	1.42
Travelling Expenses	47.00	37.69	9.93	6.48
Total	443.09	801.31	340.97	159.28

Payment to auditors

- Audit fees	1.50	3.00	3.00	3.00
Examination of Restated Financials	-	-	4.00	-
Total	1.50	3.00	7.00	3.00

26 Prior period adjustment

Particulars	Period ended	Year ended	Year ended	Year ended
	September 30, 2024	March 31, 2024	March 31, 2023	March 31, 2022
VAT paid for earlier years	-	-	1.80	-
Gratuity provided for earlier years	-	-	-	6.63
Total	-	-	1.80	6.63

Annexure V - Restated Financial Information

27 Related party disclosure

(a) Related Parties

Name of the party	Nature of relationship
Mr Sunil Menon (Managing Director) Gautam Makkar (Executive Director till September 29, 2022)	Director
Mr Hitesh Birla (Chief Financial Officer) Mrs Sonika Mehta (Company Secretary)	Key managerial personal (KMP)
Flash Forge Private Limited (Ceased to be holding company on 01/04/2021)	Enterprises over which KMP is able to exercise significant influence.

(b) Particulars of transactions with related parties

Particulars	Rupees in Lakhs, unless otherwise Stated			
	September-2024	March-2024	March-2023	March-2022
Mr Sunil Menon				
Loan Taken	-	-	-	11.60
Loan Repaid	-	-	-	12.00
Director Remuneration	42.00	84.00	42.00	-
Mr Hitesh Birla				
Salary	8.01	14.23	9.47	-
Mr Gautam Makker				
Advance given	-	7.80	-	-
Advance recovered	-	7.80	-	-
Mrs Sonika Pansari				
Salary	1.08	2.16	0.90	-
Flash Forge Pvt Ltd				
Opening Balance (Borrowings)	-	2,154.24	790.21	708.94
Loan Taken	-	133.70	2,265.35	922.93
Loan Repaid	-	2,339.75	1,068.60	841.66
Interest on loan	-	57.57	185.86	-
TDS on loan	-	5.76	18.59	-
Outstanding Balance (Borrowings)	-	-	2,154.24	790.21
Flash Forge Pvt Ltd				
Reimbursement of Expenses	150.00	260.15	487.10	360.76

(c) Related parties Balances

Particulars	September-2024	March-2024	March-2023	March-2022
Outstanding Payables				
Remuneration and salary payable				
Mr Sunil Menon	7.81	2.81	9.00	-
Mr Hitesh Birla	1.32	0.53	1.28	-
Mrs Sonika Pansari	0.18	0.18	0.17	-
Borrowings				
Flash Forge Pvt Ltd -Loan	-	-	2,154.24	790.21
Advances given/receivables				
Flash Forge Pvt Ltd	-	-	-	2.72
Payable against expenses				
Flash Forge Pvt Ltd (Reimbursement of Expenses)	64.66	1.96	68.20	-

The transactions with related parties are made on terms equivalent to those that prevail in arm's length transactions. Outstanding balances at the year-end are unsecured and settlement occurs in cash.

28 Earnings per share

Particulars	September-2024	March-2024	March-2023	March-2022
Profits attributable to the equity holders of the Company (in lakhs)	1,404.61	1,708.78	1,013.60	773.32
Weighted average number of equity shares (no's)	19,474,100	18,550,603	14,274,100	14,274,100
Earnings per share (basic)	7.21	9.21	7.10	5.42
Earnings per share (diluted)	7.21	9.21	7.10	5.42
Face value per equity share (Rs.)	10	10	10	10

29 Commitments and Contingent liabilities

(a) Commitments: Nil

(b) Contingent liabilities :

Particulars	September-2024	March-2024	March-2023	March-2022
Income tax demand for AY 2022-23	-	-	110.54	-
Income tax demand for AY 2018- 19, appeal pending with CIT (A)	394.29	394.29	-	-

CFF FLUID CONTROL LIMITED
CIN: U28990MH2012PLC227023

Annexure V - Restated Financial Information

30 Ratio Analysis

Ratio	Numerator	Denominator	September 30, 2024*	March 31, 2024	March 31, 2023	March 31, 2022	% change from March 31, 2024 to September 30, 2024	% change from March 31, 2023 to March 31, 2024	% change from March 31, 2022 to March 31, 2023
Current ratio	Current Assets	Current Liabilities	3.68	4.24	1.86	1.59	-13.20%	128.22%	17.12%
Debt- Equity Ratio	Total Debt	Shareholder's Equity	0.14	0.19	1.84	1.12	-22.98%	-89.85%	64.42%
Debt Service Coverage ratio	Earnings for debt service	Interest & Lease Payments + Principal Repayments	12.48	7.07	4.43	4.65	76.36%	59.88%	-4.92%
Return on Equity ratio	Net Profits after taxes – Preference Dividend	Average Shareholder's Equity	21.21%	22.64%	50.88%	70.65%	-6.35%	-55.50%	-27.99%
Inventory Turnover ratio	Revenue from sales of products	Average Inventory	2.89	2.38	2.43	2.30	21.79%	-2.32%	5.81%
Trade Receivable Turnover Ratio	Revenue from operations	Average Trade Receivable	5.25	12.60	6.64	4.76	-58.31%	89.75%	39.56%
Trade Payable Turnover Ratio	Purchase of Goods	Average Trade Payables	3.51	9.87	4.20	2.49	-64.42%	134.98%	68.72%
Net Capital Turnover Ratio	Revenue from operations	Average Working capital	1.61	1.76	3.06	3.65	-8.64%	-42.57%	-16.06%
Net Profit ratio	Net Profit	Revenue from operations	35.10%	15.99%	14.34%	16.46%	119.50%	11.49%	-12.85%
Return on Capital Employed	Earnings before interest and taxes	Tangible Net Worth + Total Debt + Deferred Tax Liability	26.67%	17.50%	48.36%	36.66%	52.38%	-63.81%	31.94%
Return on Investment	Gain/Interest Income from Investment	Investment	NA	NA	NA	NA	NA	NA	NA

*Ratio of September 30, 2024 are annualised to ensure consistent disclosure of numbers as compared to previous full year ended March 31, 2024.

Notes :

Percentage Change from March 31, 2022 to March 31, 2023

Particular	Reasons
Debt- Equity Ratio	Substantial increase in term loans , cash credit and corporate borrowing availed during the F.Y 2022-23 as compared to previous year.
Return on Equity ratio	With increase in net profit, the shareholder fund has also increase, thereby there is fall in ratio as compared to F.Y 2021-22
Trade Receivable Turnover Ratio	The Company has grown in terms of revenue year on year with more addition in cash sales and thereby debtors has not increased in terms of revenue leading to higher ratio.
Trade Payable Turnover Ratio	With growth in revenue, there is simultaneous rise in purchases made during the current year as compared to previous year. Further, the Company has preferred cash purchases and less credit purchases leading to rise in ratio.
Return on Capital Employed	Along with rise in revenue and purchases, the Company has been able to earn profits substantially on the same, leading to higher ratio.

Percentage Change from March 31, 2023 to March 31, 2024

Particular	Reasons
Current Asset - Current Liabilities	During the F.Y 2023-24, Company has raised funds from IPO which led to increase in Current Assets, and also increase in inventories, thereby there is increase in ratio.
Debt- Equity Ratio	The Company has repaid its corporate borrowings during the current year with use of IPO proceeds leading to fall in ratio.
Debt Service Coverage ratio	With the increase in earnings for debt service and decrease in loans due to repayment, there is increase ratio.
Return on Equity ratio	With increase in net profit, the shareholder fund has also increase mainly due to raising of capital through IPO, thereby there is fall in ratio as compared to F.Y 2022-23
Trade Receivable Turnover Ratio	The Company has grown in terms of revenue year on year with more addition in cash sales and thereby debtors has not increased in terms of revenue leading to higher ratio.
Trade Payable Turnover Ratio	With growth in revenue, there is simultaneous rise in purchases made during the current year as compared to previous year. Further, the Company has preferred cash purchases and less credit purchases leading to rise in ratio.
Net Capital Turnover Ratio	With increase in Revenue from operations there is rise in working capital used to achieve the turnover over the years.
Return on Capital Employed	Along with rise in revenue and purchases, the Company has been able to earn profits with increase in shareholder funds due to IPO leading to fall in ratio as compared to previous year.

Percentage Change from March 31, 2024 to September 30, 2024

Particular	Reasons
Debt Service Coverage ratio	With the increase in earnings for debt service and decrease in loans due to repayment and interest thereon, there is increase ratio.
Trade Receivable Turnover Ratio	The Company has grown in terms of revenue year on year with more addition in credit sales and thereby there is increase in leading to fall in ratio.
Trade Payable Turnover Ratio	With growth in revenue, there is simultaneous rise in purchases made during the current year as compared to previous year. Further, the Company has entered into higher credit purchases leading to fall in ratio.
Net Profit Ratio	The Company has grown in terms of revenue year on year and has been able to increase the profit margin over the years along with the benefit of economies of scale, leading to rise in ratio.
Return on Capital Employed	The Company has grown in terms of revenue year on year and has been able to increase the earning with the increase in shareholder fund along with the use of IPO funds in its growth.

Annexure V - Restated Financial Information

31 Employee benefits

31.1

(a) Defined contribution plan

The Company has a defined contribution plan in respect of provident fund. Contributions are made to provident fund in India for employees as per regulations. The contributions are made to registered provident fund administered by the Government of India. The obligation of the Company is limited to the amount contributed and it has no further contractual nor any constructive obligation.

Rupees in Lakhs, unless otherwise Stated

Particulars	Period ended September 30, 2024	Year ended March 31, 2024	Year ended March 31, 2023	Year ended March 31, 2022
Employer contribution to provident fund	16.85	12.70	3.62	1.80

Included in 'Contribution to provident funds' under employee benefits expense (refer note 19)

(b) Defined benefit plan

The Company provides for gratuity for employees in India as per the Payment of Gratuity Act, 1972. Employees who are in continuous service for a period of 5 years are eligible for gratuity. The amount of gratuity payable on retirement/termination is the employees last drawn basic salary per month computed proportionately for 15 days salary multiplied for the number of years of service.

Actuarial assumptions:

Particulars	Period ended September 30, 2024	Year ended March 31, 2024	Year ended March 31, 2023	Year ended March 31, 2022
Discount rate as at	6.66%	6.97%	7.15%	7.05%
Future salary increases	7.00%	7.00%	7.00%	7.00%
Mortality rate	100% of IALM 2012-14	100% of IALM 2012-14	100% of IALM 2012-14	100% of IALM 2012-14
Normal retirement age	60 years	60 years	60 years	60 years

Notes:

- Discount rate: The discount rate is based on the prevailing market yields of
- Salary escalation rate: The estimates of future salary increases considered takes into account the inflation, seniority, promotion and other relevant factors.

31.2 The amounts recognised in the balance sheet and movements in the net defined benefit obligation (DBO) are as follows :

Change in the present value of obligation	Period ended September 30, 2024	Year ended March 31, 2024	Year ended March 31, 2023	Year ended March 31, 2022
Present value of obligation at the beginning of the year	15.66	11.33	8.39	6.63
Current service cost	1.86	4.08	3.20	1.40
Interest cost	0.55	0.81	0.59	0.44
Benefits paid	-	-	-	-
Actuarial loss/(gain)	15.44	(0.57)	(0.85)	(0.08)
Past Service Cost	-	-	-	-
Present value of obligation at the end of the year	33.50	15.66	11.33	8.39

Amount recognised in the statement of profit and loss	Period ended September 30, 2024	Year ended March 31, 2024	Year ended March 31, 2023	Year ended March 31, 2022
Current service cost	1.86	4.08	3.20	1.40
Interest cost	0.55	0.81	0.59	0.44
Actuarial loss/(gain)	15.44	(0.57)	(0.85)	(0.08)
Past service cost	-	-	-	-
Total expense recognized in the statement of profit and loss	17.84	4.33	2.95	1.76

ANNEXURE V - Restated Financial Information

32 Adjustment made in restated financial statements
Adjustments having impact on profit

Rupees in Lakhs, unless otherwise Stated

Impact on Profit and Loss A/c

Particulars	Period ended September 30, 2024	Year ended March 31, 2024	Year ended March 31, 2023	Year ended March 31, 2022
Profit as per Audited Financials	1404.61	1,708.78	1,013.60	773.32
Adjustments For :				
Add/ (Less): Adjustment due to correction of error	-	-	-	-
Add/ (Less): Adjustment for provision for gratuity expenses	-	-	-	-
Add/ (Less): On account of deferred tax charge to P&L	-	-	-	-
Profit as per Restated Financials	1,404.61	1,708.78	1,013.60	773.32

Changes done in reserves & surplus has been restated for the financial years

Particulars	Period ended September 30, 2024	Year ended March 31, 2024	Year ended March 31, 2023	Year ended March 31, 2022
Reserves & Surplus as per audited financial statement	11,953.44	10,646.20	1,071.52	1,413.96
Add/ (Less): Carry forward impact of previous year	-	-	-	-
Add/ (Less): Impact on Profit and Loss A/c	-	-	-	-
Reserves & Surplus as per restated financial statement	11,953.44	10,646.20	1,071.52	1,413.96

Adjustments not having impact on profit

Appropriate adjustments have been made in the restated summary statements, wherever required, by a reclassification of the corresponding items of income, expenses, assets, liabilities and cash flows in order to bring them in line with the groupings as per the latest audited financial statements of the Company, prepared in accordance with Schedule III and the requirements of the Securities and Exchange Board of India (Issue of Capital & Disclosure Requirements) Regulations, 2018 (as amended).

Annexure V - Restated Financial Information

33 Income & Expenditure in Foreign Currency

Particulars	September-2024	March-2024	March-2023	March-2022
I) Income in Foreign Currency:	-	-	-	-
II) Expenditure in Foreign Currency:				
Pursuant to TWA Technology Transfer Agreement	132.39	849.33	-	-
Import Purchase (on CIF Basis)	2,215.77	829.96	446.05	175.81

34 Un-hedged foreign currency exposure

The foreign currency exposure of the company is not hedged. A details of Unhedged foreign currency exposure at the year end is given below: -

Particulars	September-2024	March-2024	March-2023	March-2022
Trade payables-Credit Balance (Amount EURO)	9.99	-	1.73	4.49
Trade Advances-Debit Balance (Amount EURO)	0.34	1.65	2.95	0.18
Trade payables-Credit Balance (Amount INR)	955.69	-	154.36	366.27
Trade Advances-Debit Balance (Amount INR)	32.73	149.04	263.27	15.55

35 CSR Expenditure

Particulars	September-2024	March-2024	March-2023	March-2022
Amount required to be spent by the company during the year	32.51	16.69	8.33	-
Amount of expenditure incurred	8.50	25.50	-	-
Shortfall at the end of the year	See Note Below	-	8.33	-
Total of previous years shortfall/ (Excess)	(0.48)	8.33	-	-
Movement in the provision	-	(8.50)	8.50	-

Reason for shortfall/ (Excess)

For the half year ended 30th September 2024

As the liability pertains to CSR expenditure falls till the end of the year, hence no shortfall can be considered as on 30th September 2024 which relates to financial year ending on 31st March 2025.

For the year ended 31st March 2024

The Company has made an excess expenditure under its CSR policy to the extent of Rs. 0.48 Lakhs as on 31st March 2024.

For the year ended 31st March 2023

In absence of sustainable CSR projects in hand, the Company had deposited a sum of Rs. 8.50 Lakhs pertaining to CSR expenditure for the year ended on 31st March 2023 to the "PM Cares Fund" specified under Schedule VII of the Companies Act, 2013 before due date.

Nature of CSR activities

During the year ending on 31st March 2024, the Company has in place a CSR policy laid down in accordance with the provisions of Companies Act, 2013 and rules made thereunder. The Company under its CSR policy, affirms its commitment of seamless integration of marketplace, workplace, environment and community concerns with business operations by undertaking activities / initiatives that are not taken in its normal course of business and/or confined to only the employees and their relatives and which are in line with the broad-based list of activities, areas or subjects that are set out under schedule VII of the Companies Act, 2013.

36 Other statutory information

- The Company do not have any Benami property, where any proceeding has been initiated or pending against the Company for holding any Benami property.
- The Company do not have any transactions with companies struck off under Section 248 of the Companies Act, 2013.
- The Company do not have any charges or satisfaction which is yet to be registered with ROC beyond the statutory period.
- The Company have not traded or invested in Crypto currency or Virtual Currency during the period covered by the Restated Financial Statements.
- The Company have not advanced or loaned or invested funds to any other person(s) or entity(ies), including foreign entities (Intermediaries) with the understanding that the Intermediary shall:
 - directly or indirectly lend or invest in other persons or entities identified
 - provide any guarantee, security or the like to or on behalf of the Ultimate Beneficiaries
- The Company have not received any fund from any person(s) or entity(ies), including foreign entities (Funding Party) with the understanding (whether recorded in writing or otherwise) that the Company shall:
 - directly or indirectly lend or invest in other persons or entities identified in any manner whatsoever by or on behalf of the Funding Party (Ultimate Beneficiaries) or
 - provide any guarantee, security or the like on behalf of the Ultimate Beneficiaries,
- The Company have not any such transaction which is not recorded in the books of accounts that has been surrendered or disclosed as income during the year in the tax assessments under the Income Tax Act, 1961 (such as, search or survey or any other relevant provisions of the Income Tax Act, 1961.
- Balance shown under head Sundry debtors, creditors and advances are subject to confirmation.
- There has been no delay in transferring amounts, required to be transferred, to the Investor Education and Protection Fund by the Company
- The title deeds of all the immovable properties, (other than immovable properties where the Company is the lessee and the lease agreements are duly executed in favour of the Company) disclosed in the financial statements included in property, plant and equipment and capital work-in progress are held in the name of the Company as at the balance sheet date.
- The Company did not have any long- term contracts including derivative contracts for which there were any material foreseeable losses.
- The Company has used all borrowings from bank and financial institution for the specific purpose for which it was taken at balance sheet date.
- Previous year's figures have been regrouped / reclassified wherever necessary to correspond with current year's classification.

For and on behalf of
V. N. PUROHIT & CO.
Chartered Accountants
FRN:304040E

For and on behalf of board of directors
CFF FLUID CONTROL LIMITED
CIN: U28990MH2012PLC227023

Sd/-
O.P. Pareek
Partner
Membership No: 014238
Date : 7th November 2024
Place : New Delhi
UDIN : 24014238BKAUHU4281

Sd/-
Gautam Makkar
Director
DIN: 00354956
Date : 7th November 2024
Place: Mumbai

Sd/-
Sunil Menon
Director
DIN: 00409485
Date : 7th November 2024
Place: Mumbai

Sd/-
Sonika Mehta
Company Secretary
Membership No: A63323
Date : 7th November 2024
Place: Mumbai

Sd/-
Hitesh Birla
Chief Financial Officer
PAN: AOCPB7046K
Date : 7th November 2024
Place: Mumbai

OTHER FINANCIAL INFORMATION

In accordance with the SEBI ICDR Regulations, the audited financial statements of the Company for the period ended September 30, 2024, March 31, 2024, March 31, 2023 and March 31, 2022 the reports thereon are available at www.cffdefensys.com.

The following table sets forth the Company's Accounting Ratios. This table should be read in conjunction with the sections titled "Risk Factors", "Financial Statements" and "Management's Discussion and Analysis of Financial Condition and Results of Operations" respectively.

(₹ in lakhs)

Particulars	Period ended September 30, 2024*	Year ended March 31, 2024	Year ended March 31, 2023	Year ended March 31, 2022
Restated Profit/(loss) after Tax (A)	1,404.61	1,708.78	1,013.60	773.32
Weighted average number of Equity Shares outstanding during the year/Period for Basic EPS (B)	1,94,74,100	1,85,50,603	1,42,74,100	1,42,74,100
Weighted average number of Equity Shares outstanding during the year/Period for diluted EPS (C)	1,94,74,100	1,85,50,603	1,42,74,100	1,42,74,100
Basic Earnings per Equity Share (D = A/B)	7.21	9.21	7.10	5.42
Diluted Earnings per Equity Share (E = A/C)	7.21	9.21	7.10	5.42
Restated Net Worth (F)	13,900.86	12,593.62	2,498.93	1,485.33
Return on Net Worth (G=A/F)	10.10%	13.57%	40.56%	52.06%
Actual number of equity shares at the end of the year (H)	1,94,74,100	1,94,74,100	1,42,74,100	7,13,705
Net asset value per share (Rs) - based on actual no. of equity shares at the end of the year	71.38	64.67	17.51	208.12
EBITDA	2,303.96	3,085.38	1,882.82	1,252.93

*Not Annualised

Notes to Accounting Ratios:

- 1) Basic /Diluted EPS: Net profit after tax / Equivalent weighted average number of shares outstanding during the year.
- 2) Return on Net worth: Profit after Tax / Net Worth
- 3) Net asset value: Net worth / Actual number of equity shares outstanding during the year
- 4). EBITDA = Sum of Profit before tax, finance cost and Depreciation & Amortisation

MANAGEMENT DISCUSSION AND ANALYSIS OF FINANCIAL CONDITION AND RESULTS OF OPERATION

You should read the following discussion and analysis of financial condition and results of operations together with our financial statements included in this Draft Prospectus. The following discussion relates to our Company and is based on our restated financial statements. Our financial statements have been prepared in accordance with GAAP and other applicable provisions of the Companies Act. Note: Statement in the Management Discussion and Analysis Report describing our objectives, outlook, estimates, expectations or prediction may be "Forward looking statement" within the meaning of applicable securities laws and regulations. Actual results could differ materially from those expressed or implied. Important factors that could make a difference to our operations include, among others, economic conditions affecting demand/supply and price conditions in domestic and overseas market in which we operate, changes in Government Regulations, Tax Laws and other Statutes and incidental factors.

You should read the following discussion and analysis of financial condition and results of operations together with our financial statements included in this Draft Prospectus. The following discussion relates to our Company and is based on our restated financial statements. Our financial statements have been prepared in accordance with Indian GAAP, the accounting standards and other applicable provisions of the Companies Act.

Note: Statement in the Management Discussion and Analysis Report describing our objectives, outlook, estimates, expectations or prediction may be "Forward looking statement" within the meaning of applicable securities laws and regulations. Actual results could differ materially from those expressed or implied. Important factors that could make a difference to our operations include, among others, economic conditions affecting demand/supply and price conditions in domestic and overseas market in which we operate, changes in Government Regulations, Tax Laws and other Statutes and incidental factors.

BUSINESS OVERVIEW

Our company "CFF Fluid Control Limited" was incorporated with a vision to serve the requirements of emerging defence sector of the country. We are engaged in the manufacturing and servicing of shipboard machinery, critical component systems and test facilities for submarines & surface ships for The Indian Defence PSU Shipyard. Further we also design, manufacture and service Mechanical Equipments and systems for industries like Nuclear and Clean Energy.

Currently, we operate through our manufacturing facilities located at khopoli which is entirely dedicated to cater the requirements of Indian Defence PSU Shipyard for manufacturing and supplying mechanical equipment for the "Scorpene" Submarine Program of India. After incorporation, a TOT (Transfer of Technology) was signed between CFF and Coyard SAS France for design, manufacture and supply of Mechanical Components for the Scorpene submarine program. The TOT was approved by relevant authorities and after factory inspection and our company was awarded license for production of mechanical components for the Scorpene Submarine Program.

Our manufacturing facilities located at Khopoli is spread over 6,000 sq mtrs and is well equipped with all the relevant state of the art machinery and testing facilities. We have in-house capabilities and proficiency in design, manufacturing and providing service for fluid control systems, distributor and air panels, Weapons and Control Systems, Steering gear, Propulsion Systems, High Pressure Air Systems, Hydraulics Systems, Breathing and Diving Air Systems and Integrated Platform Management Systems for submarines and surface ships for the Indian Defence PSU Shipyard and its OEMs.

Our total income as restated were ₹ 8,021.81 lakhs, ₹ 10,697.57 lakhs, ₹ 7,109.94 lakhs and ₹ 4,712.39 lakhs for the period ended September 30, 2024 and for the fiscals 2024, 2023 and 2022 respectively. Further, Our Profit after Tax had been recorded at ₹ 1,404.61 lakhs, ₹ 1,708.78 lakhs, ₹ 1,013.60 and ₹ 773.32 lakhs for the period ended September 30, 2024 and for the fiscals 2024, 2023 and 2022 respectively.

Significant Developments after September 30, 2024 that may affect our Future Results of Operations

The Directors confirm that there have been no events or circumstances since the date of the last financial statements as disclosed in the Draft Prospectus which materially or adversely affect or is likely to affect the profitability of our Company, or the value of our assets, or our ability to pay liabilities within next twelve months.

FACTORS AFFECTING OUR RESULT OF OPERATIONS

Economic conditions in the markets in which we operate

Our results of operations are dependent on the overall economic conditions in the markets in which we operate, including India. Any change in macro-economic conditions in these markets, including changes in interest rates, government policies or taxation and political, economic or other developments could affect our business and results of operations. The Defence sector in India may perform differently and be subject to market and regulatory developments that are dissimilar to the markets in other parts of the world. While stronger economic conditions tend to result into higher demand for our products, weaker economic conditions tend to result into lower demand. Change in demand in the market segments we currently supply or improvement/deterioration in the market or a change in regulations, customs, taxes or other trade barriers or restrictions could affect our operations and financial condition.

Relationship with key customers

We have historically derived, and may continue to derive, a significant portion of our income from our top 5 customers. In Fiscals 2024, Fiscal 2023 and Fiscal 2022 our top 5 customers represented 97.94%, 100% and 98.94% of our total revenues from operations respectively in such periods. Any reduction in orders from our top five customers would adversely affect our income. The demand from our key customers, in particular our top 5 customers, determines our revenue levels and results of operations, and our sales are directly affected by the production and inventory levels of our customers. Our customers in turn are dependent on budget, economic condition of country, demand and growth in Defence sector. We are trying to venture into Nuclear and Clean energy sector also which will give us more stream of revenue and may be find less concentration of our debtors. Over the years, we have developed strong relationships with a number of domestic and international corporations through which we have been able to expand our product offerings and also our geographic reach. Our business depends on the continuity of our arrangements with these customers. Our sales to such customers are typically conducted on the basis of purchase orders that they place with us from time to time.

Our ability to successfully implement its strategy and its growth and business expansion plans

Our revenue and our business operations have grown in recent years. Although we plan to continue to expand our scale of operations, we may not be able to sustain these rates of growth in future periods due to a number of factors, including, among others, our execution capability, our ability to retain, maintain & enter into new distribution agreement, our ability to maintain customer satisfaction, our ability to mobilise sufficient working capital, macroeconomic factors beyond our control such as decline in global economic conditions, availability of cheaper imported / domestic products / brands, competition within each product category from players in the organized and unorganized segments, the greater difficulty of growing at sustained rates from a larger revenue base, our inability to control our expenses and the availability of resources for our growth. There can be no assurance that we will not suffer from capital constraints, operational difficulties or difficulties in expanding existing business operations. Our strategy and revenue plan may not work and might have adverse affect on financials.

Performance Security, Defect Liability and liquidated damages

We have agreed on clause for completion of contract on timelines accepted with the customers. Our company is required to provide guarantee of some percentage of contract as performance security. After delivery of products and components we are required to provide repair and maintenance service of submarine which has life of approx 30 years. During this time, there is a timeframe of approx 12 to 60 months for which we are required to cure any manufacturing defects and other repairs. If we fail to perform, customer can get the repairs done from third party at our cost and we can even be accounted for late delivery fines. These factors increase cost and have adverse affect on our profits. We cannot assure you that we will meet all deadlines and be able to provide service which has customer satisfaction in future. We might incur delivery fines, liquidated damages in future.

RESULTS OF OUR OPERATIONS
(₹ in lakhs)

Particulars	Period ended September 30, 2024	% of Total Income	Year ended March 31, 2024	% of Total Income	Year ended March 31, 2023	% of Total Income	Year ended March 31, 2022	% of Total Income
INCOME:								
Revenue from Operations	8,003.41	99.77%	10,685.91	99.89%	7,066.63	99.39%	4,698.77	99.71%
Other Income	18.41	0.23%	11.66	0.11%	43.31	0.61%	13.62	0.29%
Total Income (A)	8,021.81	100.00%	10,697.57	100.00%	7,109.94	100.00%	4,712.39	100.00%
EXPENSES:								
Cost of Materials Consumed	4,782.86	59.62%	6,397.09	59.80%	4,633.30	65.17%	3,197.20	67.85%
Employee benefit expenses	491.91	6.13%	413.80	3.87%	251.06	3.53%	96.35	2.04%
Finance costs	105.92	1.32%	239.97	2.24%	311.07	4.38%	124.83	2.65%
Depreciation and amortization	289.41	3.61%	445.26	4.16%	131.95	1.86%	90.79	1.93%
Other expenses	443.09	5.52%	801.31	7.49%	340.97	4.80%	159.28	3.38%
Prior period expenses	-	-	-	-	1.80	0.03%	6.63	0.14%
Total Expenses (B)	6,113.18	76.21%	8,297.42	77.56%	5,670.14	79.75%	3,675.08	77.99%
Exceptional items	-	-	-	-	-	-	-	-
Net Profit / (Loss) before tax	1,908.63	23.79%	2,400.15	22.44%	1,439.80	20.25%	1,037.31	22.01%
Less: Tax expense							-	
(i) Current tax	480.25	5.99%	700.00	6.54%	383.00	5.39%	265.00	5.62%
(iii) Deferred tax	3.20	0.04%	(26.49)	(0.25)%	4.65	0.07%	(0.94)	(0.02)%
(b) Short/ Excess Tax provision for earlier periods	20.57	0.26%	17.85	0.17%	38.55	0.54%	(0.07)	0.00%
Total Tax Expense	504.02	6.28%	691.37	6.46%	426.20	5.99%	263.99	5.60%
Net Profit / (Loss) after tax	1,404.61	17.51%	1,708.78	15.97%	1,013.60	14.26%	773.32	16.41%

Main Components of our Profit and Loss Account

Income

Our total income comprises of revenue from Sale of Products, Sale of Services and other income.

Revenue from Operations

Our revenue from operations as a percentage of total income was 99.77%, 99.89%, 99.39% and 99.71%, for the period ended September 30, 2024 and fiscals 2024, 2023 and 2022 respectively.

Other Income

Our other income comprises of interest income, foreign fluctuation income and sundry balances written off. Other income, as a percentage of total income was 0.23%, 0.11%, 0.61% and 0.29%, for the period ended September 30, 2024 and fiscals 2024, 2023 and 2022 respectively

Expenditure

Our total expenditure primarily consists of raw material consumed, employee benefit expenses, finance cost, depreciation expenses, other expenses and prior period expenses.

Cost of Raw Material Consumed

It consists of cost of raw materials consumed and other direct expenses.

Employee Benefit Expenses

Employee benefit expenses comprise of salaries, director remuneration, employee welfare expenses, contribution to PF & ESIC and Gratuity.

Depreciation and Amortization Cost

Depreciation and Amortization Expenses consist of depreciation on the Tangible assets of our company i.e. Buildings, Furniture & Fixtures, Plant & Machinery, Computer and Office Equipments and Intangible Asset i.e Design Software and TWA Technology.

Finance costs

Finance cost includes Interest on Borrowings and processing expenses.

Other Expenses

Other expenses include Legal & professional expenses, Rent, Tender Fees, Late Delivery Charges, Stamp Duty Charges, Insurance expense, Telephone and Internet charges, Postage and courier charges, Auditor's fees, Bank charges and Miscellaneous expenses.

Prior period expenses

Prior period expenses include for VAT demand and Gratuity for earlier years.

Provision for Tax

The provision for current tax is computed in accordance with relevant tax regulation. Deferred tax is recognized on timing differences between the accounting and the taxable income for the year and quantified using the tax rates and laws enacted or subsequently enacted as on balance sheet date. Deferred tax assets are recognized and carried forward to the extent that there is a virtual certainty that sufficient future taxable income will be available against which such deferred tax assets can be realized in future.

Review for the six (6) months period ended September 30, 2024

Income

Our total income for the period ended Sept 30, 2024 was ₹ 8,021.81 lakhs. In the mentioned period, the revenue earned from operations was 99.77% and other income was 0.23% of the total income.

Cost of Materials Consumed

The cost of materials consumed for the period ended Sept 30, 2024 was ₹ 4,782.86 lakhs. As a proportion of our total income, it was 59.62%.

Employee Benefit Expenses

Employee Benefit Expenses for the period ended Sept 30, 2024 was ₹ 491.91 lakhs. As a proportion of our total income, it was 6.14%.

Financial Cost

Financial Cost for the period ended Sept 30, 2024 was ₹ 105.92 lakhs i.e.1.32 % of the total income for the period.

Depreciation cost

Depreciation for the period ended Sept 30, 2024 was ₹ 289.41 lakhs. As a proportion of total income it was 3.61%.

Other Expenses

Other Expenses for the period ended Sept 30, 2024 was ₹ 443.09 lakhs. As a proportion of our total income, it was 5.52%.

Profit/ (Loss) before Tax

Profit before Tax for the period ended Sept 30, 2024 was ₹ 1908.63 lakhs. i.e. 23.79% of our total income.

Tax Expenses

Our company's tax expenses for the period ended Sept 30, 2024 was ₹ 504.02 lakhs consisting of current tax, which represented 6.28 % of the total income.

Profit/ (Loss) after Tax

Profit after Tax for the period ended Sept 30, 2024 was ₹ 1404.61 lakhs i.e. 17.51% of our total income.

Our Company has been able to consistently achieve abnormal growth in business, revenue, profit with its dedication to serve the best and dive deeper into defense sector each year. Details of rise in percentage term for the key financial indicators are as below:

(Rs. in lakhs)

Particulars	F.Y 2023-24	F.Y 2022-23
Revenue from Operation	10,685.91	7,066.63
Percentage rise in Revenue from Operation year on year		51.22%
EBITDA	3,085.38	1,882.82
Percentage rise in EBITDA year on year		63.87%
Profit after Tax (PAT)	1,708.78	1,013.60
Percentage rise in profit year on year		68.59%

(Rs. in lakhs)

Particulars	F.Y 2022-23	F.Y 2021-22
Revenue from Operation	7,066.63	4,698.77
Percentage rise in Revenue from Operation year on year		50.39%

Particulars	F.Y 2022-23	F.Y 2021-22
EBITDA	1,882.82	1,252.93
Percentage rise in EBITDA year on year		50.27%
Profit after Tax (PAT)	1,013.60	773.32
Percentage rise in profit year on year		31.07%

Fiscal 2024 compared with fiscal 2023

Income

In fiscal 2024, our total income increased by ₹ 3,619.27 lakhs or 51.22%, to ₹ 10,685.91 lakhs in fiscal 2024 from ₹ 7,066.63 lakhs in fiscal 2023. The increase in the year 2022 was due to increase in the delivery of products as compared to last year.

Other income decreased by ₹ 31.64 lakhs or 73.04% to ₹ 11.66 lakhs in fiscal 2024 from ₹ 43.31 lakhs in fiscal 2023 as we recorded gain on foreign fluctuation in Fiscal 2023.

Cost of Material Consumed

Cost of material consumed increased by ₹1,763.79 lakhs or 38.07%, to ₹ 6,397.68 lakhs in Fiscal 2024 from ₹ 4,633.30 lakhs in Fiscal 2023 as we purchased bulk quantity of raw materials in line with increase in revenue orders to meet the requirement of production house. We even incurred O&M charges for servicing the parts, factory expenses and labour charges.

Employee Benefit Expenses

Employee Benefit Expenses increased by ₹ 162.74 lakhs or 64.82%, to ₹ 413.80 lakhs in fiscal 2024 from ₹ 251.06 lakhs in fiscal 2023. This decrease was mainly due to increase in salaries, bonus and staff welfare expenses and director remuneration.

Finance Costs

Finance Costs decreased by ₹ 71.09 lakhs or 22.85%, to ₹ 239.97 lakhs in fiscal 2024 from ₹ 311.07 lakhs in fiscal 2023. This decrease was mainly due to repayment of unsecured borrowing which reduced our interest cost during the year.

Depreciation Expenses

Depreciation expenses were ₹ 445.26 lakhs in fiscal 2024 as compared to ₹ 131.95 Lakhs in fiscal 2023.

Other Expenses

Other expenses increased by ₹ 460.34 lakhs or 135.01% to ₹ 801.31 lakhs in fiscal 2024 from ₹340.97 lakhs in Fiscal 2023. The increase majorly consisted of rent expenses, Donation, CSR Fund, Foreign fluctuation loss, Tender Fees, and legal and professional fees paid during the year.

Prior Period Expenses

It comprises of VAT expenses of ₹ 1.80 lakhs booked in Fiscal 2023.

Profit/ (Loss) before Tax

The increase in scale of operations has led to increase in our Profit before tax by ₹ 960.35 lakhs or 66.70 % to ₹ 2,400.15 lakhs in fiscal 2024 from ₹ 1,439.80 lakhs in fiscal 2023.

Tax Expenses

The Company's tax expenses had increased by ₹ 265.17 lakhs to 691.37 lakhs in the Fiscal 2024 from ₹ 426.20 lakhs in Fiscal 2023 as tax liability increases with rise in profits earned during the year.

Profit/ (Loss) after Tax

After accounting for taxes at applicable rates, our Profit after Tax increased by ₹ 695.18 lakhs or 68.59% to ₹1,708.78 lakhs in fiscal 2024 from ₹ 1,013.60 lakhs in fiscal 2023. Factors such as increase in order book, growth in revenue by delivering the order as per schedules, economies of scale with rise in business and decrease in cost over years, installment of better technology and better fund management has led to rise in profit margin.

Fiscal 2023 compared with fiscal 2022

Income

In fiscal 2023, our total income increased by ₹ 2,367.86 lakhs or 50.39%, to ₹ 7,066.63 lakhs in fiscal 2023 from ₹ 4,698.77 lakhs in fiscal 2022. The increase in the year 2023 was due to increase in the word orders granted and delivery of products as compared to last year.

Other income increased by ₹ 29.69 lakhs or 217.93 % to ₹ 43.31 lakhs in fiscal 2023 from ₹ 13.62 lakhs in fiscal 2022 as we recorded gain on foreign fluctuation in Fiscal 2023.

Cost of Material Consumed

Cost of material consumed increased by ₹1,436.10 lakhs or 44.92% to ₹ 4,633.30 lakhs in Fiscal 2023 from ₹ 3,197.20 lakhs in Fiscal 2022 as we purchased bulk quantity of raw materials to meet the requirement of production house. We even incurred delivery and labour charges and job work charges for some orders.

Employee Benefit Expenses

Employee Benefit Expenses increased by 154.70 lakhs or 160.56% to ₹ 251.06 lakhs in fiscal 2023 from ₹ 96.35 lakhs in fiscal 2022. This increase was mainly due to increase in salaries, bonus and staff welfare expenses and addition of director remuneration.

Finance Costs

Finance Costs increased by ₹ 186.24lakhs or 149.19% to ₹ 311.07 lakhs in fiscal 2023 from ₹ 124.83 lakhs in fiscal 2022. This increase was mainly due to increase in borrowing and interest cost on unsecured loans during the year.

Depreciation Expenses

Depreciation expenses were ₹ 131.95 lakhs in fiscal 2023 as compared to ₹ 90.79 Lakhs in fiscal 2022.

Other Expenses

Other expenses increased by ₹ 181.69 lakhs or 114.07% to ₹ 340.97 lakhs in fiscal 2023 from ₹159.28 lakhs in Fiscal 2022. The increase majorly consisted of stamp duty expenses, late delivery charges, rent expenses, filing expenses and legal and professional fees paid during the year.

Prior Period Expenses

It comprises of VAT expenses of ₹ 1.80 lakhs booked in Fiscal 2023 and Gratuity for earlier years booked in Fiscal 2022 for ₹ 6.63 lakhs.

Profit/ (Loss) before Tax

The increase in scale of operations has led to increase in our Profit before tax by ₹ 402.49 lakhs or 38.80 % to ₹ 1,439.80 lakhs in fiscal 2023 from 1,037.31 lakhs in fiscal 2022.

Tax Expenses

The Company's tax expenses had increased by ₹ 162.21 lakhs to 426.20 lakhs in the Fiscal 2023 from ₹ 263.99 lakhs in Fiscal 2022 as tax liability increases with rise in profits earned during the year.

Profit/ (Loss) after Tax

After accounting for taxes at applicable rates, our Profit after Tax increased by ₹ 240.28 lakhs or 31.07% to ₹1,013.60 lakhs in fiscal 2023 from 773.32 lakhs in fiscal 2022.

Cash Flows

(₹`in lakhs)

Particulars	For the period ended	For the year ended March 31		
	September 2024	2024	2023	2022
Net Cash from Operating Activities	(678.18)	(2,675.37)	(927.20)	919.69
Net Cash from Investing Activities	(174.63)	(1,659.53)	(1,939.46)	10.45
Net Cash used in Financing Activities	(457.68)	5,904.32	2,619.28	(726.87)
Net Increase / (Decrease) in Cash and Cash equivalents	(1,310.49)	1569.41	(247.37)	203.27

Cash Flows from Operating Activities

Net cash from operating activities for the period ended Sept 30, 2024 was ₹ (678.18) lakhs as compared to the PBT of ₹ 1908.63 lakhs for the same period. This difference is primarily on increase in trade and other receivables, change in short-term loans and advances payment of trade and other payables, change in inventories.

Net cash from operating activities for the fiscal 2024 was ₹ (2,675.34) lakhs as compared to the PBT of ₹ 2,400.15 lakhs for the same period. This difference is primarily on increase in change in short-term loans and advances payment of trade and other payables, change in inventories.

Net cash from operating activities in fiscal 2023 was ₹ (927.20) lakhs as compared to the PBT of ₹ 1439.80 lakhs for the same year. This difference is primarily on increase in trade and other receivables, change in short-term loans and advances payment of trade and other payables, change in inventories and other current assets.

Net cash from operating activities in fiscal 2022 was ₹ 919.69 lakhs as compared to the PBT of ₹ 1037.31 lakhs for the same year. This difference is primarily on increase in trade and other receivables, change in short-term loans and advances, payment of trade and other payables, change in inventories and other current liability.

Cash Flows from Investment Activities

For the period ended Sept 30, 2024 the net cash invested in investing activities was ₹ 174.63 lakhs. This was majorly on account of addition in vehicles, plant and machinery and TWA technology.

In fiscal 2024 the net cash invested in investing activities was ₹ 1,659.53 lakhs. This was majorly on account of addition in furniture and fixtures, plant and machinery and TWA technology.

In fiscal 2023, the net cash invested in investing activities was ₹ 1,939.46 lakhs. This was majorly on account of addition in building, plant and machinery and office equipment.

In fiscal 2022, the net cash generated in investing activities was ₹ 10.45 lakhs from interest income on deposits.

Cash Flows from Financing Activities

Net cash used in financing activities for the period ending Sept 30, 2024 was ₹ 457.68 lakhs. This was on account of repayment of borrowings and finance cost incurred during the year.

Net cash generated in financing activities in fiscal 2024 was 5904.32 lakhs. This was on account of fund raised through IPO during the year and repayment of long term borrowings and finance cost incurred during the year.

Net cash generated from financing activities in fiscal 2023 was 2619.28 lakhs. This was on account of proceeds from loans.

Net cash used in financing activities in fiscal 2022 was 726.87 lakhs. This was on account of repayment of short-term and finance cost incurred during the year.

OTHER MATTERS

1. Unusual or infrequent events or transactions

Except as described in this Draft Prospectus, during the period/ years under review there have been no transactions or events, which in our best judgment, would be considered unusual or infrequent.

2. Significant economic changes that materially affected or are likely to affect income from continuing Operations

Other than as described in the Section titled “*Financial Information*” and chapter titled “*Management’s Discussion and Analysis of Financial Conditions and Results of Operations*” on page no. 140 and 159 respectively of this Draft Prospectus respectively, to our knowledge there are no significant economic changes that materially affected or are likely to affect income from continuing Operations.

3. Known trends or uncertainties that have had or are expected to have a material adverse impact on revenue or income from continuing operations

Other than as described in the chapter titled “*Risk Factors*” and “*Management’s Discussion and Analysis of Financial Conditions and Result of Operations*” on page no. 20 and 159 respectively of this Draft Prospectus respectively, best to our knowledge there are no known trends or uncertainties that have or had or are expected to have a material adverse impact on revenues or income of our company from continuing operations.

4. Future relationship between Costs and Income

Other than as described in the chapter titled “*Risk Factors*” on page no. 20 of this Draft Prospectus, best to our knowledge there are no factors, which will affect the future relationship between costs and income or which are expected to have a material adverse impact on our operations and finances.

5. The extent to which material increases in revenue or income from operations are due to increased volume, introduction of new services or increased prices

Increase in revenues is by and large linked to increase in delivery of order book and volume of business activity thereby, completing and receiving more orders for our products.

6. Status of any publicly announced new services or business segments

Please refer to the chapter titled “*Our Business*” on page no. 89 of this Draft Prospectus.

7. The extent to which the business is seasonal.

Our business is not seasonal in nature.

8. Any significant dependence on a single or few suppliers or customers

For September 2024, the revenue from our top 5 and top 10 customers constituted approximately 91.35 % and 100.00% respectively of the revenue from operations. For September 2024, the purchases from our top 5 and top 10 suppliers constituted approximately 81.62 % and 90.84% respectively of the revenue from operations. For fiscal 2024, the revenue from our top 5 and top 10 customers constituted approximately 97.94 % and 100.00% respectively of the revenue from operations. For fiscal 2024, the purchases from our top 5 and top 10 suppliers constituted approximately 81.56 % and 100.00% respectively of the revenue from operations. For further details, please refer chapter “*Our Business*” on page no. 89 of this Draft Prospectus.

9. Competition Conditions

We face competition from various domestic and international players in the market. Most of our competitors are at global level in defence, nuclear and clean energy sector of the industry. We intend to continue competing rigorously to capture more market share and manage our growth in an optimal way. We expect that our commitment to quality, past record of timely execution and transparency will provide us with an edge over our competitors. Further we believe that our competition also depends on several factors which include changing business framework, government policy, competitive price, delivery at given timeline and established relationship with suppliers, brand recognition etc

CAPITALISATION STATEMENT

The following table sets forth the Company's capitalization as at September 30, 2024, derived from our Restated Financial Statements, and as adjusted for the Offer. This table should be read in conjunction with the sections titled "Risk Factors", "Financial Statements" and "Management's Discussion and Analysis of Financial Condition and Results of Operations" respectively.

(Rs in lakhs)

Particulars	Pre-Issue as at September 30, 2024	As adjusted for the proposed Issue*
Short Term Borrowings (incl current maturities)	1,424.84	[•]
Long Term Borrowings	577.36	[•]
Total Borrowings (A)	2,002.20	[•]
Equity Share Capital	1,947.41	[•]
Other Equity	11,953.45	[•]
Total Equity (B)	13,900.86	[•]
Ratio: Short term borrowing / Total equity (B)	0.10	
Ratio: Total Borrowings (A) / Total Equity (B)	0.14	[•]

*The corresponding post FPO capitalization data for each of the amounts given in the above table is not determinable at this stage and hence the same has not been provided in the above statement.

FINANCIAL INDEBTEDNESS

The Company avails loan and financing facilities in the ordinary course of business for meeting working capital and business requirements

The details of the indebtedness of the Company as on September 30, 2024 is provided below:

(Rs. In lakhs)

Nature of Borrowings	September 30, 2024
Secured Borrowings (fund Based)	2,002.20
Total	2,002.20

Credit facilities:

Particulars	Sanction Letter Date	Amount Sanctioned (Rs. in lakhs)	Amount Outstanding as on September 30, 2024 (Rs. in lakhs)	Interest Rate	Nature of credit facility
Axis Bank	March 30, 2024	142.00	114.39	Repo +2.75%=9.25%	WCTL-ECLGS
		1,500.00	1,231.43		Cash Credit
		700.00	618.34		Term Loan
HDFC Bank	July 04, 2024	21.98	21.40	9.45%	Auto Loan
Kotak Mahindra Prime Limited	June 30, 2024	17.44	16.64	9.52%	Auto Loan
Total		2,381.42	2,002.20		

Note 1: Details of security for above Credit Facilities:

1. Primary Security:
 - Extension of hypothecation on the entire current assets of the Company both present & future.
 - First and exclusive hypothecation charge on machineries financed out by the bank.
2. Collateral security:
 - Extension of Equitable Mortgage of the following properties:
 - a) Industrial Property situated at plot no.1, Survey no. 96, Village Kumbhivali, Taluka Khalapur, Dist. Raigad, owned by Company.
 - b) EM/RM of Residential Flat No B-2202, Adonia, Hiranandani Gardens, Powai owned by Company.
3. Personal Guarantee by our Directors Sunil Menon and Gautam Makker.
4. ECLGS: Second Charge on Primary and Collateral Securities except Guarantees and 100% Guarantee from NCGTC.

Note 2: HDFC Bank loan is secured against the Honda City Car.

Note 3: Kotak Mahindra Prime Limited loan is secured against the Urban Cruiser Car.

Note 5: Bank loans contain certain debt covenants relating to limitation on indebtedness, debt-equity ratio, net Borrowings to EBITDA ratio and debt service coverage ratio.

Note 6: Our Company enjoys Bank Guarantee of Rs. 2,000.00 lakhs from Axis Bank. As on September 30, 2024 our Company has outstanding Bank Guarantee of Rs 961.43 lakhs.

STOCK MARKET DATA FOR EQUITY SHARES OF OUR COMPANY

The Equity Shares are listed on the SME Platform of BSE. The Equity Shares being issued pursuant to this Issue will be listed on SME Platform of BSE. For further details, see “*Issue Information*” on page 194.

For the purpose of this section, unless otherwise specified:

- Year is a financial year;
- Average price is the average of the daily closing prices of the Equity Shares for the year, or the month, as the case may be;
- High, low and average prices are based on the daily closing prices of the Equity Shares for the year, or the month, as the case may be; and
- In case of two days with the same high/low/closing price, the date with higher volume has been considered.

The high, low and average market prices of the Equity Shares recorded on BSE during the preceding three years and the number of the Equity Shares traded on the days of the high and low prices were recorded are as stated below:

A. BSE

Year	High (₹)	Date of High	Volume on date of High (No. of Equity Shares)	Low (₹)	Date of low	Volume on date of Low (No. of Equity Shares)	Average (₹)
2023	494.40	September 05, 2023	3,28,800	165.00	June 16, 2023	4,67,200	294.27
2024	949.00	July 03, 2024	3,65,600	355.00	March 12, 2024	1,38,400	617.11

Monthly high and low prices and trading volumes on the Stock Exchange for the six months preceding the date of filing of this Offer Document are as stated below:

B. BSE

Month Year	High (₹)	Date of High	Volume on date of High (No. of Equity Shares)	Low (₹)	Date of low	Volume on date of Low (No. of Equity Shares)	Average price for the month (₹)
July 2024	949.00	July 03, 2024	1,34,800	750.00	July 24, 2024	30,000	864.78
August 2024	810.00	August 01, 2024	24,000	669.00	August 29, 2024	27,200	724.81
September 2024	777.15	September 12, 2024	26,000	625.00	September 30, 2024	10,400	700.44
October 2024	637.00	October 01, 2024	9,200	524.00	October 24, 2024	37,600	577.41
November 2024	700.00	November 05, 2024	39,200	562.60	November 18, 2024	26,000	638.24
December 2024	765.00	December 12, 2024	16,800	652.00	December 30, 2024	12,000	710.63

Week end prices of Equity Shares along with the highest and lowest closing prices on the Stock Exchange for the last four weeks preceding the date of filing of this Offer Document is as stated below:

BSE				
For the Week ended on		Closing Price (₹)	High (₹)	Low (₹)
Week 4	December 20, 2024	686.55	701.00	680.00
Week 3	December 27, 2024	697.85	715.00	685.00
Week 2	January 03, 2025	701.10	718.00	685.00
Week 1	January 10, 2025	681.50	700.95	680.00

High and low, prices are closing prices of that, particular week.

The closing market price of the Equity Shares of our Company one Working Day prior to the date of this Offer Document i.e. January 10, 2024 was ₹ 681.50 on BSE. The Offer Price is ₹ [●] per Equity Share and our Company has arrived at it in consultation with the BRLM.

Our Board has, pursuant to its resolution dated September 05, 2024, authorized the Offer for an amount aggregating up to ₹ [●] lakhs. The closing price of the Equity Shares on September 06, 2024 (*i.e.* the next trading day after September 05, 2024 on which the Company's shares were traded) on BSE was ₹ 685.40

SECTION VIII – LEGAL AND OTHER INFORMATION

OUTSTANDING LITIGATION AND MATERIAL DEVELOPMENTS

Except as stated in this section, there are no: (i) criminal proceedings; (ii) actions by statutory or regulatory authorities; (iii) claims relating to direct and indirect taxes; (iv) disciplinary actions including penalties imposed by SEBI or stock exchanges against the Promoters in the last five financial years, including outstanding action; or (v) Material Litigation (as defined below); involving our Company, its Directors and Promoters.

Our Board, in its meeting held on November 07, 2024, determined that outstanding legal proceedings involving the Company, its Directors and Promoters will be considered as material litigation (“Material Litigation”) if the aggregate amount involved in such individual litigation exceeds 5% of Revenue of the Company, as per the last audited financial statements of the Company or such litigations outcome could have a material impact on the business, operations, prospects or reputations of the Company.

Our Company, Directors and Promoters are not Wilful Defaulter or a Fraudulent Borrower.

LITIGATION INVOLVING OUR COMPANY

A. LITIGATION AGAINST OUR COMPANY

1. Criminal matters

NIL

2. Litigation Involving Actions by Statutory/Regulatory Authorities

NIL

3. Litigation involving Tax Liabilities

(i) Direct Tax Liabilities

Type of Direct Tax	No. of cases/ matters	Amount in dispute/ demanded (Rs. in Lakhs)
Income Tax	2	397.117

(ii) Indirect Taxes Liabilities

NIL

4. Other Pending Litigations

NIL

B. LITIGATION FILED BY OUR COMPANY

1. Litigation Involving Criminal matters

NIL

2. Litigation Involving Actions by Statutory/Regulatory Authorities

NIL

3. Litigation involving Tax Liabilities

(i) Direct Tax Liabilities

NIL

(ii) **Indirect Taxes Liabilities**

NIL

4. **Other Pending Litigations**

NIL

LITIGATION INVOLVING OUR PROMOTERS AND DIRECTORS

A. LITIGATION AGAINST OUR PROMOTERS AND DIRECTORS

1. **Criminal matters**

NIL

2. **Litigation Involving Actions by Statutory/Regulatory Authorities**

NIL

3. **Litigation involving Tax Liabilities**

(i) **Direct Tax Liabilities**

Type of Direct Tax	No. of cases/ matters	Amount in dispute/ demanded (<i>Rs. in Lakhs</i>)
Sunil Menon		
Income Tax	7	270.48
Gautam Makker		
Income Tax	5	178.57

(ii) **Indirect Taxes Liabilities**

NIL

4. **Other Pending Litigations**

NIL

B. LITIGATION FILED BY OUR PROMOTERS AND DIRECTORS

1. **Litigation Involving Criminal matters**

NIL

2. **Litigation Involving Actions by Statutory/Regulatory Authorities**

NIL

3. **Litigation involving Tax Liabilities**

(i) **Direct Tax Liabilities**

NIL

(ii) **Indirect Taxes Liabilities**

NIL

4. Other Pending Litigations

NIL

LITIGATION INVOLVING GROUP COMPANY

LITIGATION AGAINST OUR GROUP COMPANY

1. Litigation involving Criminal matters

Criminal Revision Application no. 140/SC/OF 2022 (“the Criminal Revision Application”) filed by M/s. Flash Forge Private Limited (“the Applicant”) against M/s Sangeeta Metal Corporation (“the Respondent/Complainant”) under section 138 of the Negotiable Instruments Act, 1881 before Court of Session Judge, Greater Mumbai.

Flash Forge Pvt. Ltd. (the Applicant), along with its directors, is currently facing legal proceedings under Section 138 of the Negotiable Instruments Act due to the dishonour of two cheques issued by the Flash Forge Pvt. Ltd. These cheques, totalling Rs. 55,16,105/- (Fifty Five Lakhs Sixteen Thousand One Hundred and Five only), were meant to discharge an outstanding debt to Sangeeta Metal Corporation, represented by Mr. Shantilal Mangilal Shah, the proprietor. The cheques were issued for the supply of industrial raw materials by Sangeeta Metal to Flash Forge between February 2020 and October 2020. Despite the agreed payment dates passing, the Applicant failed to make the required payments, resulting in an outstanding principal amount of Rs. 1,04,10,755, along with accrued interest. When the cheques were dishonored due to insufficient funds, the complainant filed a criminal complaint against Flash Forge for dishonor of cheques, alleging intentional negligence and fraudulent conduct.

Flash Forge, however, contends that full payment of the outstanding amount was made through several RTGS transactions. The company claims that despite these payments, the complainant did not acknowledge or respond to its efforts to settle the matter. In this regard, Flash Forge made several attempts to resolve the dispute amicably, including a meeting on 22nd January 2024 with the complainant’s advocate to discuss withdrawing the complaint. However, the complainant’s advocate cited personal unavailability, and no further progress was made. Between 22nd January 2024 and 22nd February 2024, Flash Forge’s legal representatives made additional attempts to contact the complainant’s advocate but were unsuccessful in reaching a settlement.

As a result, Flash Forge filed a Criminal Revision Application on 23rd February 2024, challenging the issuance of process by the Metropolitan Magistrate on 17th January 2023. The company acknowledges a delay of 59 days in filing the Revision Application, attributing the delay to ongoing discussions with the complainant regarding the settlement. Flash Forge asserts that the delay was not intentional and that it would suffer grave harm and loss if the delay is not condoned. The company has therefore requested the Court to condone the delay in filing the Revision Application, and it seeks any appropriate relief, while ensuring that no prejudice is caused to the complainant. The Criminal Revision Application is ongoing.

2. Litigation Involving Actions by Statutory/Regulatory Authorities

NIL

3. Litigation involving Tax Liabilities

(i) Direct Tax Liabilities

Type of Direct Tax	No. of cases/ matters	Amount in dispute/ demanded (Rs. in Lakhs)
Income Tax	6	17,702.89

(ii) Indirect Taxes Liabilities

NIL

4. Other Pending Litigations

NIL

B. LITIGATION FILED BY OUR GROUP COMPANY

1. Criminal matters

NIL

2. Litigation Involving Actions by Statutory/Regulatory Authorities

NIL

3. Litigation involving Tax Liabilities

(i) Direct Tax Liabilities

NIL

(ii) Indirect Taxes Liabilities

NIL

4. Other Pending Litigations

NIL

Amounts owed to small scale undertakings and other creditors

As of September 30, 2024, our Company owes the following amounts to small scale undertakings, other creditors and material creditors:

(Rs. in lakhs)

Particulars	Number of Creditors	Amount involved
Micro, Small and Medium Enterprise	-	-
Material Creditors	1	944.40
Other Creditor	59	154.74
Total Creditors	60	1,099.14

Details in relation to the amount owed by our Company to material creditors, small scale undertakings and other creditors as on September 30, 2024 are also available on www.cffdefensys.com

It is clarified that information provided on the website of our Company is not a part of this Draft Prospectus and should not be deemed to be incorporated by reference. Anyone placing reliance on any other source of information, including our Company's website, would be doing so at its own risk.

Disciplinary action including penalty imposed by SEBI or stock exchanges against the promoter in the last five financial years

There are no disciplinary actions including penalty imposed by SEBI or Stock Exchanges against the Promoters during the last 5 financial years including outstanding actions.

Material developments occurring after last balance sheet date

Except as disclosed elsewhere in this Draft Prospectus, there have been no material developments that have occurred after the Last Balance Sheet Date.

GOVERNMENT AND OTHER STATUTORY APPROVALS

We have received the necessary consents, licenses, permissions and approvals from the Government and various governmental agencies required for our present business (as applicable on date of this Draft Prospectus) and except as mentioned below, no further approvals are required for carrying on our present business.

In view of the approvals listed below, we can undertake this Issue and our current/proposed business activities and no further major approvals from any governmental or regulatory authority or any other entity are required to be undertaken in respect of the Issue or to continue our business activities. It must be distinctly understood that, in granting these approvals, the Government of India does not take any responsibility for our financial soundness or for the correctness of any of the statements made or opinions expressed in this behalf. Unless otherwise stated, these approvals are all valid as of the date of this Draft Prospectus.

The main objects clause of the Memorandum of Association and objects incidental to the main objects enable our Company to carry out its activities. The following are the details of licenses, permissions and approvals obtained by the Company under various Central and State Laws for carrying out its business:

I. APPROVALS FOR THE ISSUE

1. The Board of Directors have, pursuant to Section 23 and Section 62 (1)(c) of the Companies Act 2013, by a resolution passed at its meeting held on September 05, 2024 authorized the Offer, subject to the approval of the shareholders and such other authorities as may be necessary.
2. The shareholders of our Company have, pursuant to Section 62(1)(c) of the Companies Act, 2013, by special resolution passed in the Annual General Meeting held on September 30, 2024 authorized the Issue.
3. The Board have approved and taken on record the Draft Offer Document pursuant to the resolution dated January 11, 2025.
4. Our Company's International Securities Identification Number (“**ISIN**”) is INE0NJ001013

II. APPROVALS PERTAINING TO INCORPORATION

a. Approvals obtained by the Company

1. Certificate of Incorporation dated February 16, 2012 issued under the name Flash Forge Fluid Control Private Limited by Registrar of Companies, Mumbai, Maharashtra.
2. Fresh Certificate of Incorporation dated October 19, 2012 issued by Registrar of Companies, Mumbai, Maharashtra pursuant to change of name from Flash Forge Fluid Control Private Limited to CFF Fluid Control Private Limited.
3. Fresh Certificate of Incorporation dated September 15, 2022 issued by Registrar of Companies, Mumbai Maharashtra consequent to conversion of the Company “CFF Fluid Control Private Limited” to “CFF Fluid Control Limited”.
4. The Corporate Identity Number of the Company is U28990MH2012PLC227023

III. TAX AND LABOUR RELATED APPROVALS

a. Tax Related Approvals

Sr. No.	Description	Registration / Approval / Certificate N umber	Issuing Authority	Date of Issue	Date of Expiry
1.	Permanent Account Number (PAN)	AAFCC3630A	Income Tax Department, Government of India	October 19, 2012	Valid until cancelled

Sr. No.	Description	Registration / Approval / Certificate Number	Issuing Authority	Date of Issue	Date of Expiry
2.	Tax Deduction Account Number (TAN)	MUMC20160A	Income Tax Department, Government of India	December 21, 2013	Valid until cancelled
3.	Certificate of Registration issued under the provisions of Central Goods and Service Tax Act, 2017 for premise Plot No.01, Survey No.96, Savroli Khar Pada Road, Kumbhivali, Khalapur Khopoli, Mumbai- 410203	27AAFCC3630A1Z9	Government of India	December 01, 2019	Valid until cancelled
4.	Central Excise Registration Certificate under Central Excise Rules, 2002 with respect to manufacturing of Excisable goods at Plot No.01, Survey No. 96, Service Road, Kumbhivali-Madap, Khalapur- Khopoli, Raigad, Maharashtra.	AAFCC3630AEM001	Deputy/Assistant Commissioner of Central Excise, Raigarh- Maharashtra	April 07, 2016	Valid until cancelled
5.	Certificate of Enrolment under the Maharashtra State Tax on Professions, Trades, Callings and Employments Act, 1975	99302098451P	Maharashtra Sales Tax Department	November 25, 2013	Valid until cancelled
6.	Certificate of Registration under the Maharashtra State Tax on Professions, Trades, Callings and Employments Act, 1975	27831012899P	Maharashtra Sales Tax Department	December 27, 2013	Valid until cancelled
7.	Import Exporter Code for Company's Plot No. 1, Survey No. 96, Kumbhivli, Madap Khopoli, Khalapur, Raigad- 410203	0313081921	Directorate General of Foreign trade, Ministry of Commerce and Industry	February 28, 2014	Valid until cancelled

b. Registrations related to Labour Laws

Sr. No.	Description	Registration / Approval / Certificate Number	Issuing Authority	Date of Issue	Date of Expiry
1.	Registration under Employees' State Insurance Act, 1948	34000524860001001	Deputy. Director, Employees' State Insurance Corporation	September 27, 2021	Valid until cancelled

Sr. No.	Description	Registration / Approval / Certificate Number	Issuing Authority	Date of Issue	Date of Expiry
2.	Provident Fund Code	10000204983VSH	Regional Provident Fund Commissioner, Maharashtra	November 29, 2018	Valid until cancelled

IV. KEY BUSINESS RELATED APPROVALS

Sr. No.	Description	Registration / Approval / Certificate Number	Issuing Authority	Date of Issue	Date of Expiry
1.	Factory License	122002529000384	Government of Maharashtra	January 01, 2024	December 31, 2033
2.	Establish and Operate Under Green Category	0000150646/CO/2211001662	Maharashtra Pollution Control Board	November 21, 2022	November 30, 2028
3.	UDYAM Registration Certificate	UDYAM-MH-19-0032637	Government of India	January 08, 2021	Valid until cancelled
4.	ISO 9001:2015 Certificate for Design, Manufacture, Marketing & Sales of Marine & Industrial Valves	01 100 2137549	International Organization for Standardization	December 02, 2021	December 01, 2024*
5.	Udyog Aadhaar Registration	UAN: MH27B0000906	Ministry of Micro Small & Medium Enterprises	March 31, 2016	Valid until cancelled

* Our company have submitted an application for the renewal of our ISO certification. We will provide an update in the Prospectus once the renewed certificate is received.

INTELLECTUAL PROPERTY

For details regarding Intellectual Property, please refer chapter titled “Our Business” beginning on page no. 89 of this Draft Prospectus

V. MATERIAL PENDING APPROVAL

A. Applied but not yet received Approval

- NA

B. Applications yet to be made

- The Company has not obtained No Objection Certificate from the concerned Fire Officer in accordance with the provisions of the Maharashtra Fire Prevention and Life Safety Measures Act, 2006, in respect of the Company’s manufacturing facility.

SECTION IX – OTHER REGULATORY AND STATUTORY DISCLOSURES

Authority for the Issue

1. The Fresh Issue of Equity Shares in terms of this draft prospectus has been authorized by a resolution by the Board of Directors passed at their meeting held on September 05, 2024 under Section 62(1)(c) of the Companies Act 2013 and subject to the approval of the members and such other authorities as may be necessary.
2. The Fresh Issue of Equity Shares in terms of this draft prospectus has been authorized by the shareholders by special resolution passed by way of postal ballot dated September 30, 2024 under Section 62(1)(c), and other applicable provisions of the Companies Act 2013.
3. Our Company has received In-principal approval from BSE vide their letter dated [●] to use the name of BSE in this draft prospectus for listing of the Further Equity Shares on SME Platform of BSE Limited. BSE Limited is the Designated Stock Exchange.
4. Our Board has approved the draft Prospectus through its resolution dated January 11, 2025.

Confirmation:

- Our Company, our Promoters, Promoter Group, our Directors, person(s) in control of the promoter or our Company have not been prohibited from accessing the capital market or debarred from buying, selling or dealing in securities under any order or direction passed by the SEBI or any securities market regulator in any other jurisdiction or any other authority/court.
- Our Company, our Promoters, Promoters' Group are in compliance with the Companies (Significant Beneficial Ownership) Rules, 2018.
- None of our Directors are in any manner associated with the securities market and there has been no action taken by the SEBI against the Directors or any other entity with which our Directors are associated as promoters or directors.
- None of the Directors are associated with any entities, which are engaged in securities market related business and are registered with SEBI for the same.
- There are no violations of securities laws committed by any of them in the past or pending against them, nor have any companies with which any of our Company, our Promoter, Directors, persons in control of our Company or any natural person behind the Promoter are or were associated as a promoter, director or person in control, been debarred or prohibited from accessing the capital markets under any order or direction passed by the SEBI or any other regulatory or government authority.
- Neither our Company, nor our Promoters, our Directors, relatives (as per Companies Act, 2013) of Promoter or the person(s) in control of our Company have been identified as a willful defaulter by the RBI or other governmental authority and there has been no violation of any securities law committed by any of them in the past and no such proceedings are pending against any of them except as details provided under Section titled, “*Outstanding Litigations and Material Developments*” beginning on page no. 173 of this draft prospectus.
- Our Company is a “Listed Issuer” in terms of the SEBI (ICDR) Regulations; and this Issue is a “Further Public Issue” in terms of the SEBI (ICDR) Regulations.

Eligibility for the Issue

This issue is being made in terms of Regulation 281 read with Chapter IV of the SEBI ICDR Regulations, 2018, as amended time to time.

- Our Company is not ineligible in terms of Regulations 102 of SEBI ICDR Regulations for this Issue as:

- Neither our company, nor any of its promoters, promoter group or directors are debarred from accessing the capital market by the Board.
- Neither our promoters, nor any directors of our company is a promoter or director of any other company which is debarred from accessing the capital market by the Board
- Neither our Promoter nor any of our Directors is declared as Fugitive Economic Offender
- Neither our Company, nor our Promoter, relatives (as defined under the Companies Act, 2013) of our Promoter nor our Directors, are Willful Defaulters
- Our company confirms that it is eligible to make the issue under Regulation 102 and 103 of the SEBI ICDR regulation, to the extent applicable.
- Our Company is also eligible for the Issue in accordance with Regulation 229 and other provisions of Chapter IX of the SEBI (ICDR) Regulations 2018.
- Our Company further confirms that it will ensure compliance with the conditions specified in Regulation 104 of the SEBI ICDR Regulations, to the extent applicable.
- Our Company is in compliance with Part A of Schedule VI of the SEBI ICDR Regulations.

OTHER CONFIRMATIONS

- a) The Company was incorporated on February 16, 2012 with the Registrar of Companies, Mumbai under Companies Act, 1956 in India, hence is in existence for a minimum period of 3 years on the date of filing the Draft Prospectus with BSE.
- b) As on the date of this Draft Prospectus, the Company has a Paid-up Capital of Rs. 1,947.41 Lakhs and the Post Issue Capital will be of Rs. [●] Lakhs which is less than 25 Crores.
- c) As on March 31, 2024, the Company has net tangible assets on Rs. 11,739.45 Lakhs.
- d) The Company confirms that it has operating profits (earnings before interest, depreciation and tax) from operations for atleast 2 financial years out of preceding three financial years and its net-worth is at least Rs. 1 crore for preceding 2 financial years.
- e) The Company has a track record of at least 3 years as on the date of filling Draft Prospectus.
- f) The Leverage ratio (Total Debts to Total Equity) of the Company as on March 31, 2024 was 0.19:1 which less than the limit of 3:1.
- g) The Company confirms that there has not been any change in its name in last 1 year.
- h) The Company has no pending defaults in respect of payment of interest and/or principal to the debenture/ bond/ fixed deposit holders by our Company and promoters.
- i) No regulatory action of suspension of trading against the promoter(s) or companies promoted by the promoters by any stock Exchange having nationwide trading terminals.
- j) The Promoters or directors are not the promoters or directors (other than independent directors) of compulsory delisted companies by the Exchange and neither they are the promoters or directors of such companies on which the consequences of compulsory delisting is applicable/attracted or companies that are suspended from trading on account of non-compliance
- k) There has been no change in the Promoters of the Company in the preceding one year from date of filing application to BSE for listing on SME Platform of BSE.
- l) No material regulatory or disciplinary action by a stock exchange or regulatory authority in the past three years against the applicant Company.
- m) None of the Directors of the Company have been disqualified / debarred by any of the Regulatory Authorities

- n) Our Company has a website: www.cffdefensys.com
- o) Company has not been referred to NCLT under IBC.
- p) There is no winding up petition against the company, which has been admitted by the court.
- q) The Company has facilitated trading in demat securities and has entered into an agreement with both the depositories. Our Company has entered into an agreement with Central Depository Services Limited (CDSL) dated October 12, 2022 and National Securities Depository Limited (NSDL) dated October 13, 2022 for dematerialization of its Equity Shares.
- r) The entire pre-Issue capital of our Company has shares fully paid-up Equity Shares and the Equity Shares proposed to be issued pursuant to this FPO will be fully paid-up.
- s) The Equity Shares of our Company held by our Promoters are in dematerialised form.
- t) Our Company has made firm arrangements of finance through verifiable means towards seventy five per cent of the stated means of finance for funding from the fresh issue proceeds, excluding the amount to be raised through the proposed public issue or through existing identifiable internal accruals. For details, please refer the chapter “Objects of the Issue” on page no. 62 of this Draft Prospectus.
- u) No show-cause notices and adjudication proceedings, have been initiated / issued by SEBI and pending against the Company or its whole-time directors as on the date of this Draft Prospectus.
- v) The Company has not received any complaints from the investors till the end of the quarter immediately preceding the month of filing this Draft Prospectus with the Stock Exchange.
- w) Our Company, our Promoters or our Directors have not settled any alleged violation of securities laws through the consent or settlement mechanism with SEBI
- x) No material regulatory or disciplinary action by a stock exchange or regulatory authority in the past three years against the applicant Company. Further the Equity Shares of the Company have not been suspended from trading as a disciplinary measure during last three years immediately preceding the date of filing of this Draft Prospectus with the Stock Exchange.

We further confirm that:

- i. In accordance with Regulation 260 of the SEBI (ICDR) Regulations, this issue is 100% underwritten and that the Lead Manager to the Issue shall underwrite minimum 15% of the Total Issue Size.
- ii. In accordance with Regulation 269 of the SEBI (ICDR) Regulations, we shall ensure that the total number of proposed Allottee’s in the issue shall be greater than or equal to fifty (50), otherwise, the entire application money will be refunded within 4 (Four) days of such intimation. If such money is not repaid within 4 (Four) days from the date our Company becomes liable to repay it, then our Company and every officer in default shall, on and from expiry of 4 (Four) days, be liable to repay such application money, with interest at the rate 15% per annum. Further, in accordance with Section 40 of the Companies Act, 2013, the Company and each officer in default may be punishable with fine and/or imprisonment in such a case.
- iii. We shall be complying with all other requirements as laid down for such Issue in the SEBI (ICDR) Regulations, as amended from time to time and subsequent circulars and guidelines issued by SEBI and the Stock Exchange.
- iv. In terms of Regulation 246 (1) of the SEBI (ICDR) Regulations, 2018, a copy of the prospectus will be filed with the SEBI through the Lead Manager immediately upon filing of the offer document with the Registrar of Companies. However, as per Regulation 246 (2) of the SEBI (ICDR) Regulations, 2018, The Board shall not issue any observation on the offer document.

Further, in terms of Regulation 246 (3) of the SEBI (ICDR) Regulations, 2018 the lead manager will also submit a due diligence certificate as per format prescribed by SEBI along with the prospectus to SEBI.

Further, in terms of Regulation 246 (4) of the SEBI (ICDR) Regulations, 2018 the prospectus will be displayed from the date of filing in terms of sub-regulation (1) on the website of the Board, The Lead Manager and the SME Exchange of BSE.

Moreover, in terms of Regulation 246 (5) of the SEBI (ICDR) Regulations, 2018, a copy of this draft prospectus and prospectus shall also be furnished to the Board in a soft copy.

DISCLAIMER CLAUSE OF SEBI

IT IS TO BE DISTINCTLY UNDERSTOOD THAT SUBMISSION OF ISSUE DOCUMENT TO THE SECURITIES AND EXCHANGE BOARD OF INDIA (SEBI) SHOULD NOT IN ANY WAY BE DEEMED OR CONSTRUED THAT THE SAME HAS BEEN CLEARED OR APPROVED BY SEBI. SEBI DOES NOT TAKE ANY RESPONSIBILITY EITHER FOR THE FINANCIAL SOUNDNESS OF ANY SCHEME OR THE PROJECT FOR WHICH THE ISSUE IS PROPOSED TO BE MADE OR FOR THE CORRECTNESS OF THE STATEMENTS MADE OR OPINIONS EXPRESSED IN THE ISSUE DOCUMENT. THE LEAD MANAGER HAS CERTIFIED THAT THE DISCLOSURES MADE IN THE ISSUE DOCUMENT ARE GENERALLY ADEQUATE AND ARE IN CONFORMITY WITH THE REGULATIONS. THIS REQUIREMENT IS TO FACILITATE INVESTORS TO TAKE AN INFORMED DECISION FOR MAKING INVESTMENT IN THE PROPOSED ISSUE.

IT SHOULD ALSO BE CLEARLY UNDERSTOOD THAT WHILE THE ISSUER IS PRIMARILY RESPONSIBLE FOR THE CORRECTNESS, ADEQUACY AND DISCLOSURE OF ALL RELEVANT INFORMATION IN THE ISSUE DOCUMENT, THE LEAD MANAGER IS EXPECTED TO EXERCISE DUE DILIGENCE TO ENSURE THAT THE ISSUER DISCHARGES ITS RESPONSIBILITY ADEQUATELY IN THIS BEHALF AND TOWARDS THIS PURPOSE, THE LEAD MANAGER, M/S. ARYAMAN FINANCIAL SERVICES LIMITED HAS FURNISHED TO STOCK EXCHANGE A DUE DILIGENCE CERTIFICATE DATED [●], IN THE FORMAT PRESCRIBED UNDER SCHEDULE V(A) OF THE SEBI (ICDR) REGULATION 2018 WHICH SHALL ALSO BE SUBMITTED TO SEBI AFTER FILING THE PROSPECTUS WITH ROC AND BEFORE OPENING OF THE ISSUE IN ACCORDANCE WITH THE SEBI ICDR REGULATION, 2018

THE FILING OF THIS ISSUE DOCUMENT DOES NOT, HOWEVER, ABSOLVE OUR COMPANY FROM ANY LIABILITIES UNDER THE COMPANIES ACT, 2013 OR FROM THE REQUIREMENT OF OBTAINING SUCH STATUTORY OR OTHER CLEARANCES AS MAY BE REQUIRED FOR THE PURPOSE OF THE PROPOSED ISSUE. SEBI FURTHER RESERVES THE RIGHT TO TAKE UP AT ANY POINT OF TIME, WITH THE LEAD MANAGER ANY IRREGULARITIES OR LAPSES IN THE OFFER DOCUMENT.

THE DUE DILIGENCE CERTIFICATE TO BE SUBMITTED AS PER FORM A OF SCHEDULE V INCLUDING ADDITIONAL CONFIRMATION AS PROVIDED IN FORM G OF SCHEDULE V IS PRODUCED AS UNDER:

We, the lead merchant banker to the above-mentioned forthcoming issue, state and confirm as follows:

1. We have examined various documents including those relating to litigation, including commercial disputes, patent disputes, disputes with collaborators, etc. and other material while finalisation of the draft prospectus pertaining to the said issue;
2. On the basis of such examination and the discussions with the issuer, its directors and other officers, other agencies, and independent verification of the statements concerning the objects of the issue, price justification and the contents of the documents and other papers furnished by the issuer, we confirm that:

- A. the draft prospectus filed with the exchange/board is in conformity with the documents, materials and papers which are material to the issue;
 - B. all material legal requirements relating to the issue as specified by the board, the central government and any other competent authority in this behalf have been duly complied with; and
 - C. the material disclosures made in the draft prospectus are true, fair and adequate to enable the investors to make a well-informed decision as to the investment in the proposed issue and such disclosures are in accordance with the requirements of the companies act, 2013, applicable provisions of the companies act, 1956, the securities and exchange board of india (issue of capital and disclosure requirements) regulations, 2018 and other applicable legal requirements.
3. We confirm that besides ourselves, all the intermediaries named in the draft prospectus are registered with the board and that till date such registration is valid.
 4. We have satisfied ourselves about the capability of the underwriters to fulfill their underwriting commitments.
 5. We certify that written consent from promoters has been obtained for inclusion of their specified securities as part of promoters' contribution subject to lock-in and the specified securities proposed to form part of promoters' contribution subject to lock-in shall not be disposed / sold / transferred by the promoter during the period starting from the date of filing the draft prospectus with the board/exchange till the date of commencement of lock-in period as stated in the draft prospectus.
 6. We certify that all applicable provision of the securities and exchange board of india (issue of capital and disclosure requirements) regulations, 2018, which relates to specified securities ineligible for computation of promoters contribution, has been and shall be duly complied with and appropriate disclosures as to compliance with the said regulation have been made in the draft prospectus.
 7. We undertake that all applicable provision of the securities and exchange board of india (issue of capital and disclosure requirements) regulations, 2018 which relate to receipt of promoters contribution prior to opening of the issue shall be complied with. we confirm that arrangements have been made to ensure that promoters' contribution shall be received at least one day before the opening of the issue and that auditors' certificate to this effect shall be duly submitted to the board/exchange. we further confirm that arrangements have been made to ensure that promoters' contribution shall be kept in an escrow account with a scheduled commercial bank and shall be released to the issuer along with the proceeds of the public issue. – ***not applicable***
 8. We confirm that necessary arrangements have been made to ensure that the moneys received pursuant to the issue are kept in a separate bank account as per the provisions of sub-section (3) of section 40 of the companies act, 2013 and that such moneys shall be released by the said bank only after permission is obtained from all the stock exchange mentioned in the draft prospectus. we further confirm that the agreement entered into between the bankers to the issue and the issuer specifically contains this condition.
 9. We certify that the proposed activities of the issuer for which the funds are being raised in the present issue fall within the 'main objects' listed in the object clause of the memorandum of association or other charter of the issuer and that the activities which have been carried out until now are valid in terms of the object clause of its memorandum of association.
 10. We certify that all the shares shall be issued in dematerialized form in compliance with the provisions of section 29 of the companies act, 2013 and the depositories act, 1996, and the regulations made thereunder.
 11. We certify that all the applicable disclosures mandated in the securities and exchange board of india (issue of capital and disclosure requirements) regulations, 2018 have been made in addition to disclosures which, in our view, are fair and adequate to enable the investor to make a well-

informed decision.

12. We certify that the following disclosures have been made in the draft prospectus:
 - A. an undertaking from the issuer that at any given time, there shall be only one denomination for the equity shares of the issuer and
 - B. an undertaking from the issuer that it shall comply with such disclosure and accounting norms specified by the board from time to time.
13. We undertake to comply with the regulations pertaining to advertisement in terms of the securities and exchange board of india (issue of capital and disclosure requirements) regulations, 2018.
14. We enclose a note explaining the process of due diligence that has been exercised by us including in relation to the business of the issuer, the risk in relation to the business, experience of the promoters and that the related party transaction entered into for the period disclosed in the draft prospectus have been entered into by the issuer in accordance with applicable laws.
15. We enclose a checklist confirming regulation-wise compliance with the applicable provisions of the securities and exchange board of india (issue of capital and disclosure requirements) regulations, 2018, containing details such as the regulation number, its text, the status of compliance, page number of the draft prospectus where the regulation has been complied with and our comments, if any.
16. We enclose statement on 'price information of past issues handled by merchant banker below (who are responsible for pricing this issue)', as per format specified by sebi through circular no. cir/cfd/dil/7/2015 dated october 30, 2015.

Additional confirmations/certification to be given by merchant banker in due diligence certificate to be given along with issue document regarding SME platform of BSE limited.

- (1) we confirm that none of the intermediaries named in the draft prospectus have been debarred from functioning by any regulatory authority.
- (2) we confirm that all the material disclosures in respect of the issuer have been made in draft prospectus and certify that any material development in the issuer or relating to the issue up to the commencement of listing and trading of the specified securities issued through this issue shall be informed through public notices/advertisements in all those newspapers in which pre-issue advertisement and advertisement for opening or closure of the issue have been given.
- (3) we confirm that the abridged prospectus contains all the disclosures as specified in the securities and exchange board of india (issue of capital and disclosure requirements) regulations, 2018 - *noted for compliance*.
- (4) we confirm that agreements have been entered into with the depositories for dematerialisation of the specified securities of the issuer.
- (5) the issuer has redressed at least ninety-five per cent of the complaints received from the investors till the end of the quarter immediately preceding the month of filing of the offer document with the registrar of companies.
- (6) we confirm that underwriting and market making arrangements as per requirements of regulation 261 and 262 of the securities and exchange board of india (issue of capital and disclosure requirements) regulations, 2018 have been made.

DISCLAIMER FROM OUR COMPANY AND THE LEAD MANAGER

Our Company and the Lead Manager accept no responsibility for statements made otherwise than those contained in this draft prospectus or in the advertisements or any other material issued by or at our

Company's instance and that anyone placing reliance on any other source of information would be doing so at his or her own risk.

CAUTION

The LM accepts no responsibility, save to the limited extent as provided in the Issue Agreement entered between the LM (Aryaman Financial Services Limited) and our Company on November 05, 2024 and the Underwriting Agreement dated [●], entered into between the Underwriters and our Company and the Market Making Agreement dated [●], entered into among the Market Maker and our Company.

All information shall be made available by our Company and the LM to the public and investors at large and no selective or additional information would be available for a section of the investors in any manner whatsoever including at road show presentations, in research or sales reports, at collection centres or elsewhere.

The LM and their respective associates and affiliates may engage in transactions with, and perform services for, our Company, our Promoter Group, or our affiliates or associates in the ordinary course of business and have engaged, or may in future engage, in commercial banking and investment banking transactions with our Company, our Promoter Group, Group Entities, and our affiliates or associates, for which they have received and may in future receive compensation.

Note: Investors who apply in the Issue will be required to confirm and will be deemed to have represented to our Company and the Underwriters and their respective directors, officers, agents, affiliates and representatives that they are eligible under all applicable laws, rules, regulations, guidelines and approvals to acquire Equity Shares of our Company and will not Issue, sell, pledge or transfer the Equity Shares of our Company to any person who is not eligible under applicable laws, rules, regulations, guidelines and approvals to acquire Equity Shares of our Company. Our Company, the Underwriters and their respective directors, officers, agents, affiliates and representatives accept no responsibility or liability for advising any investor on whether such investor is eligible to acquire the Equity Shares in the Issue.

DISCLAIMER IN RESPECT OF JURISDICTION

This Issue is being made in India to persons resident in India (including Indian nationals resident in India who are majors, HUFs, companies, corporate bodies and societies registered under applicable laws in India and authorized to invest in shares, Indian mutual funds registered with SEBI, Indian financial institutions, commercial banks, regional rural banks, cooperative banks (subject to RBI permission), or trusts under applicable trust law and who are authorized under their constitution to hold and invest in shares, public financial institutions as specified in Section 2(72) of the Companies Act, 2013, VCFs, state industrial development corporations, insurance companies registered with the Insurance Regulatory and Development Authority, provident funds (subject to applicable law) with a minimum corpus of ₹ 2,500.00 Lakh and pension funds with a minimum corpus of ₹ 2,500.00 Lakh, and permitted non-residents including FIIs, Eligible NRIs, multilateral and bilateral development financial institutions, FVCIs and eligible foreign investors, insurance funds set up and managed by army, navy or air force of the Union of India and insurance funds set up and managed by the Department of Posts, India provided that they are eligible under all applicable laws and regulations to hold Equity Shares of our Company. This draft prospectus does not, however, constitute an Issue to sell or an invitation to subscribe for Equity Shares Issued hereby in any jurisdiction other than India to any person to whom it is unlawful to make an Issue or invitation in such jurisdiction. Any person into whose possession this draft prospectus comes is required to inform himself or herself about, and to observe, any such restrictions.

Any dispute arising out of this Issue will be subject to jurisdiction of the competent court(s) in **Mumbai, Maharashtra, India** only.

No action has been, or will be, taken to permit a public Issuing in any jurisdiction where action would be required for that purpose. Accordingly, the Equity Shares represented hereby may not be Issued or sold, directly or indirectly, and this draft prospectus may not be distributed in any jurisdiction, except in accordance with the legal requirements applicable in such jurisdiction. Neither the delivery of this draft

prospectus nor any sale hereunder shall, under any circumstances, create any implication that there has been no change in the affairs of our Company from the date hereof or that the information contained herein is correct as of any time subsequent to this date.

DISCLAIMER CLAUSE OF THE SME PLATFORM OF BSE

As required, a copy of the Draft Prospectus shall be submitted to the SME Platform of BSE Limited. The Disclaimer Clause as intimated by the SME Platform of BSE Limited to us, post scrutiny of the Draft Prospectus, shall be included in the Prospectus prior to the filing with RoC.

DISCLAIMER CLAUSE UNDER RULE 144A OF THE U.S. SECURITIES ACT

The Equity Shares have not been, and will not be, registered under the U.S. Securities Act 1933, as amended (the "Securities Act") or any state securities laws in the United States and may not be Issued or sold within the United States or to, or for the account or benefit of, "U.S. persons" (as defined in Regulation S under the Securities Act), except pursuant to an exemption from, or in a transaction not subject to, the registration requirements of the Securities Act. Accordingly, the Equity Shares will be Issued and sold outside the United States in compliance with Regulation S of the Securities Act and the applicable laws of the jurisdiction where those Issues and sales occur. The Equity Shares have not been, and will not be, registered, listed or otherwise qualified in any other jurisdiction outside India and may not be Issued or sold, and Applicants may not be made by persons in any such jurisdiction, except in compliance with the applicable laws of such jurisdiction.

Further, each Applicant where required agrees that such Applicant will not sell or transfer any Equity Shares or create any economic interest therein, including any off-shore derivative instruments, such as participatory notes, issued against the Equity Shares or any similar security, other than pursuant to an exemption from, or in a transaction not subject to, the registration requirements of the Securities Act and in compliance with applicable laws and legislations in each jurisdiction, including India.

LISTING

The existing Equity Shares of our company are listed on the SME platform of BSE. The Equity Shares issued through this Issue are proposed to be listed on SME platform of BSE. Our Company has obtained in-principle approval from BSE by way of its letter dated [●], for listing of further equity shares on SME platform of BSE.

BSE will be the Designated Stock Exchange, with which the Basis of Allotment will be finalized for the Issue. If the permission to deal in and for an official quotation of the Equity Shares on the SME Platform is not granted by BSE, our Company shall forthwith repay, without interest, all moneys received from the applicants in pursuance of this draft prospectus. If such money is not repaid within four (4) days from the date our Company becomes liable to repay it, then our Company and every officer in default shall, on and from expiry of four (4) days, be liable to repay such application money, with interest at the rate as prescribed under the Companies Act, 2013.

Our Company shall ensure that all steps for the completion of the necessary formalities for listing and commencement of trading at the SME Platform of BSE mentioned above are taken within Six (6) Working Days of the Issue Closing Date.

FILING

The draft prospectus is being filed with BSE Limited, 20th Floor, P.J. Towers, Dalal Street, Fort, Mumbai-400001, Maharashtra. After getting in-principal approval from BSE, a copy of the prospectus, along with the documents required to be filed under Section 26 of the Companies Act, 2013 would be delivered for filing to the Registrar of Companies.

A copy of this prospectus shall be furnished to SEBI in soft copy. A copy of the prospectus shall be filed with SEBI immediately upon filing of the Offer document with Registrar of Companies in term of Regulation 246 of the SEBI (ICDR) Regulations, 2018. However, SEBI shall not issue any observation on the prospectus.

IMPERSONATION

Attention of the Applicants is specifically drawn to the provisions of sub-section (1) of Section 38 of the Companies Act, 2013 which is reproduced below:

Any person who-

- Makes or abets making of an application in a fictitious name to a company for acquiring, or subscribing for, its securities; or
- Makes or abets making of multiple applications to a company in different names or in different combinations of his name or surname for acquiring or subscribing for its securities; or
- Otherwise induces directly or indirectly a company to allot, or register any transfer of, securities to him, or to any other person in a fictitious name,

Shall be liable to action under Section 447 of the Companies, Act 2013.

CONSENTS

Consents in writing of (a) Our Directors, Our Promoters, Our Company Secretary & Compliance Officer, Chief Financial Officer, Our Statutory Auditor, Key Managerial Personnel, Our Peer Review Auditor, Our Banker(s) to the Company; (b) Lead Manager, Registrar to the Issue, Banker(s) to the Issue*, Legal Advisor to the Issue, Underwriter(s) to the Issue* and Market Maker to the Issue* to act in their respective capacities shall be obtained as required under Section 26 of the Companies Act, 2013 and shall be filed along with a copy of the draft prospectus with the RoC, as required under Sections 32 of the Companies Act, 2013 and such consents will not be withdrawn up to the time of delivery of the draft prospectus for filing with the RoC.

** Will be obtained before filing of the Prospectus*

In accordance with the Companies Act, 2013 and the SEBI (ICDR) Regulations, M/s. V.N. Purohit & Co, Chartered Accountants, have provided their written consent to the inclusion of their reports dated November 07, 2024, on Restated Financial Statements and to the inclusion of their reports dated November 08, 2024, on Statement of Tax Benefits, which may be available to the Company and its shareholders, included in this Draft Prospectus in the form and context in which they appear therein and such consents and reports have not been withdrawn upto the time of filing of this Draft Prospectus.

EXPERTS OPINION

Except as stated below, our Company has not obtained any expert opinions:

Our Company has received written consent from the Statutory Auditor namely, M/s. V.N. Purohit & Co, Chartered Accountants, to include their name as required under Section 26(1)(a)(v) of the Companies Act, 2013 in this Prospectus and as “Expert” as defined under section 2(38) of the Companies Act, 2013 in respect to their Report on Restated Financial Statements dated November 07, 2024 and Report on Statement of Tax Benefits dated November 08, 2024 and issued by them, included in this Draft Prospectus and such consent has not been withdrawn as on the date of this Draft Prospectus.

However, the term “expert” shall not be construed to mean an “expert” as defined under the U.S. Securities Act.

CAPITAL ISSUE DURING THE LAST FIVE YEARS

PREVIOUS PUBLIC AND RIGHTS ISSUES

We are “Listed Issuer” in terms of the SEBI ICDR Regulations and this Offer is a “Further Public Offer” in terms of the SEBI ICDR Regulations. Except as stated below, we have not made any other previous rights and/or public issues during last 5 years:

Particulars	Details
Year of Issue	2023
Type of Issue	Initial Public Offer
Issue Size	₹ 8,580.00 lakhs
Issue Price	₹ 165.00 (including premium of ₹ 155.00)

Particulars	Details
Date of Opening of Issue	May 30, 2023
Date of Closure of Issue	June 02, 2023
Date of Allotment	June 08, 2023
Date of Listing on Designated Stock Exchange	June 12, 2023

PERFORMANCE VIS-À-VIS OBJECTS –PUBLIC/ RIGHTS ISSUE OF LISTED GROUP COMPANY / SUBSIDIARIES / ASSOCIATES OR LISTED PROMOTERS

As on the date of this Draft Prospectus, there are no listed group Company / Subsidiary / Associates or Listed Promoters.

COMMISSION AND BROKERAGE PAID ON PREVIOUS ISSUES OF THE EQUITY SHARES

Our Company has listed its shares pursuant its IPO on June 12, 2023. Commissions and brokerages have been paid

PERFORMANCE VIS-À-VIS OBJECTS-PUBLIC/RIGHTS ISSUE OF OUR COMPANY

Other than the IPO vide Prospectus dated May 23, 2023, our Company has not made any rights issue or public issue during the five (05) years immediately preceding the date of this Offer Document.

Particulars	Proposed Object as per Prospectus	Actual Utilisation
Funding Working Capital requirements of the Company	2,941.53	2,941.53
Repayment of Loans	2,100.00	2,100.00
Purchase of machinery and equipment	886.00	886.00
Acquire Technology of “ Towed Wire Antenna (TWA)”	850.00	850.00
General Corporate Purpose	1,671.02	1,671.02
Total	8,448.55	8,448.55

TRACK RECORD OF PAST ISSUES HANDLED BY THE LEAD MANAGER

For details regarding the track record of the Lead Manager to the Offer as specified in Circular reference CIR/MIRSD/1/ 2012 dated January 10, 2012 issued by the SEBI, please see the website of Aryaman Financial Services Limited – www.afsl.co.in

Price Information of past issues handled by the Lead Manager

Price information of past issues (during current financial year and two financial years preceding the current financial year) handled by Aryaman Financial Services Limited.

Sr. No.	Issue Name	Issue size (₹ in Cr.)	Issue Price (₹)	Listing date	Opening price on listing date	+/- % change in Price on closing price, [+/- % change in closing benchmark]- 30 th calendar days from listing		+/- % change in Price on closing price, [+/- % change in closing benchmark]- 90 th calendar days from listing		+/- % change in Price on closing price, [+/- % change in closing benchmark]- 180 th calendar days from listing	
1.	Indo Farm Equipment Limited	260.15	215.00	07-01-25	258.40	NA	NA	NA	NA	NA	NA
2.	Khyati Global Ventures Limited	18.29	99.00	11-10-24	105.00	(30.81%)	(2.33%)	(32.31%)	(4.62%)	NA	NA
3.	Vraj Iron and Steel Limited	171.00	207.00	03-07-24	240.00	9.42%	1.24%	26.96%	5.35%	6.01%	(2.17%)
4.	Shivam Chemicals Limited	20.18	44.00	30-04-24	48.00	11.75%	(0.80%)	22.73%	9.23%	14.39%	6.60%
5.	Arrowhead Seperation Engineering Limited	13.00	233.00	28-11-23	250.00	(18.43%)	9.42%	(22.75%)	10.00%	(36.46%)	13.96%
6.	Mish Designs Limited	9.76	122.00	07-11-23	160.00	5.53%	7.05%	22.13%	10.45%	2.46%	13.76%
7.	Sunita Tools Limited	22.04	145.00	11-10-23	155.00	9.90%	(2.36%)	106.21%	7.39%	107.17%	12.44%
8.	Master Components Limited	15.42	140.00	29-09-23	140.40	0.21%	(3.01%)	2.11%	10.90%	(4.96%)	12.66%
9.	HMA Agro Industries Limited	480.00	585	04-07-23	615.00	1.60%	(0.36%)	28.88%	0.53%	43.59%	10.33%
10.	CFF Fluid Control Limited	85.80	165.00	12-06-23	175.00	61.79%	4.26%	378.48%	6.18%	161.82%	11.32%

Summary Statement of Disclosure

Financial Year	Total no. of IPOs	Total Funds Raised (₹ in Cr.)	Nos. of IPOs trading at discount - 30 th calendar day from listing day			Nos. of IPOs trading at premium - 30 th calendar day from listing day			Nos. of IPOs trading at discount - 180 th calendar day from listing day			Nos. of IPOs trading at premium - 180 th calendar day from listing day		
			Over 50%	Between 25-50%	Less than 25%	Over 50%	Between 25-50%	Less than 25%	Over 50%	Between 25-50%	Less than 25%	Over 50%	Between 25-50%	Less than 25%
2024-25	4	469.62	0	1	0	0	0	2	0	0	0	0	0	2
2023-24	6	626.02	0	0	1	1	0	4	0	1	1	2	1	1
2022-23	6	445.79	0	0	2	3	0	1	0	0	2	3	0	1

Notes:

(1) Since the listing date of Indo Farm Equipment Limited was on January 07, 2025 information related to closing price and benchmark index as on the 30th, 90th and 180th calendar day from the listing date is not applicable.

(2) Since the listing date of Khyati Global Ventures Limited was on October 11, 2024 information related to closing price and benchmark index as on the 180th calendar day from the listing date is not applicable.

(3) As on the 180th calendar day from the listing day, the price of HMA Agro Industries Limited is Rs.84, considering the corporate announcement i.e. Stock Split of Share from face value Equity Shares of ₹10 each to ₹1/- each. Actual price as on 180th calendar day would have being ₹840.

(4) The respective Designated Stock Exchange for each Issue has been considered as the Benchmark index for each of the above Issues.

(5) In the event any day falls on a holiday, the price/index of the immediate preceding working day has been considered. If the stock was not traded on the said calendar days from the date of listing, the share price is taken of the immediately preceding trading day.

(6) Source: www.bseindia.com and www.nseindia.com BSE Sensex and Nifty Fifty as the Benchmark Indices.

OUTSTANDING DEBENTURES OR BOND ISSUES OR REDEEMABLE PREFERENCE SHARES OR ANY OTHER CONVERTIBLE INSTRUMENTS ISSUED BY OUR COMPANY

Our Company does not have any outstanding debentures or bonds or Preference Redeemable Shares as on the date of filing this draft prospectus.

OPTION TO SUBSCRIBE

Equity Shares being issued through the draft prospectus can be applied for in dematerialized form only.

DISPOSAL OF INVESTOR GRIEVANCES

MECHANISM FOR REDRESSAL OF INVESTOR GRIEVANCES

The Company has appointed Cameo Corporate Services Ltd as the Registrar to the Issue, to handle the investor grievances in co-ordination with the Compliance Officer of the Company. All grievances relating to the present Issue may be addressed to the Registrar with a copy to the Compliance Officer, giving full details such as name, address of the applicant, number of Equity Shares applied for, amount paid on application and name of bank and branch. The Company would monitor the work of the Registrar to ensure that the investor grievances are settled expeditiously and satisfactorily.

The Registrar to the Issue will handle investor's grievances pertaining to the Issue. A fortnightly status report of the complaints received and redressed by them would be forwarded to the Company. The Company would also be co-ordinating with the Registrar to the Issue in attending to the grievances to the investor.

All grievances relating to the ASBA process may be addressed to the SCSBs, giving full details such as name, address of the applicant, number of Equity Shares applied for, amount paid on application and the Designated Branch of the SCSB where the Application Form was submitted by the ASBA Applicant. We estimate that the average time required by us or the Registrar to the Issue or the SCSBs for the redressal of routine investor grievances will be seven business days from the date of receipt of the complaint. In case of non-routine complaints and complaints where external agencies are involved, we will seek to redress these complaints as expeditiously as possible.

The Company has obtain authentication on the SCORES and comply with the SEBI circular (CIR/OIAE/1/2013) dated April 17, 2013 in relation to redressal of investor grievances through SCORES.

Our Board has constituted the Stakeholders' Relationship Committee vide Board Resolution dated November 04, 2022 in accordance with the Section 178 of the Companies Act, 2013. The Stakeholders' Relationship Committee comprises of following members:

Name of the Directors	Nature of Directorship	Designation in Committee
Priyanka Moondra Rathi	Non Executive Independent Director (NEID)	Chairman
Rajnish Prakash	Non Executive Independent Director (NEID)	Member
Gautam Makker	Non Executive Director	Member

For further details, please see the chapter titled "*Our Management*" beginning on page no 120 of this Draft Prospectus.

Our Company has also appointed Sonika Mehta, as the Compliance Officer for the Issue and she may be contacted at the Registered Office of our Company.

Name: Sonika Mehta

Address:503, Delphi, A Wing, Orchard Avenue,

Hiranandani Business Park,
Powai, Mumbai-400076
Tel: +91-2246086806
Email id: compliance@cffdefensys.com

Investors can contact the Compliance Officer or the Registrar to the Issue or the Lead Manager in case of any pre Issue or post Issue related problems, such as non-receipt of letters of Allotment, credit of Allotted Equity Shares in the respective beneficiary accounts and refund orders

STATUS OF INVESTOR COMPLAINTS

We confirm that there are no pending investor complaints as on the date of this Draft Prospectus.

DISPOSAL OF INVESTOR GRIEVANCES BY LISTED COMPANIES UNDER THE SAME MANAGEMENT

None of our Group Companies / Associates / Subsidiaries is listed on any Stock Exchange as on the date of filing this Draft Prospectus.

SECTION X – ISSUE INFORMATION

TERMS OF THE ISSUE

The Equity Shares being Issued are subject to the provisions of the Companies Act, SCRA, SCRR, SEBI (ICDR) Regulations, the SEBI Listing Regulations, our Memorandum and Articles of Association, the terms of this draft prospectus, the draft prospectus, the abridged prospectus, Application Form, CAN, the Revision Form, Allotment advices, and other terms and conditions as may be incorporated in the documents/certificates that may be executed in respect of the Issue. The Equity Shares shall also be subject to all applicable laws, guidelines, rules, notifications and regulations relating to the issue of capital and listing and trading of securities issued from time to time by SEBI, the GoI, the Stock Exchanges, the RoC, the RBI and/or other authorities, as in force on the date of the Issue and to the extent applicable.

Please note that in terms of regulation 256 of the SEBI (ICDR), 2018 read with SEBI Circular CIR/CFD/POLICYCELL/11/2015 dated November 10, 2015, all the investors applying in this issue shall use only Application Supported by Blocked Amount (ASBA) facility for making payment i.e. just writing their bank account numbers and authorising the banks to make payment in case of allotment by signing the application forms. Further, pursuant to SEBI Circular No. SEBI/HO/CFD/DCR2/CIR/P/2019/133 dated November 08, 2019, Retail Individual Investors applying in public issue may use either Application Supported by Blocked Amount (ASBA) process or UPI payment mechanism by providing UPI ID in the Application Form which is linked from Bank Account of the investor.

AUTHORITY FOR THE PRESENT ISSUE

The present Public Issue of up to 15,00,000 Equity Shares has been authorized by a resolution of the Board of Directors of our Company at their meeting held on September 05, 2024 and was approved by the Shareholders of the Company by passing Special Resolution at the Annual General Meeting held on September 30, 2024 in accordance with the provisions of Section 62(1)(c) of the Companies Act, 2013.

RANKING OF EQUITY SHARES

The Equity Shares being Issued shall be subject to the provisions of the Companies Act, 2013 and our Memorandum and Articles of Association and shall rank *pari-passu* in all respects with the existing Equity Shares of our Company including rights in respect of dividend. The allottees, upon Allotment of Equity Shares under this Issue, will be entitled to receive dividends and other corporate benefits, if any, declared by our Company after the date of Allotment. For further details, please refer to Section titled, “*Description of Equity Shares and Terms of the Articles of Association*”, beginning on page 228 of this draft prospectus.

OFFER FOR SALE

In the case of offer for sale, the dividend for the entire year shall be payable to the transferees and the company has to disclose the name of the entity bearing the cost of making offer for sale along with reasons. However, the present issue does not include offer for sale and hence the said disclosure is not applicable to us.

MODE OF PAYMENT OF DIVIDEND

Our Company shall pay dividend to the shareholders of our Company in accordance with the provisions of the Companies Act, 2013, as may be applicable, the Articles of Association of our Company, the provisions of the SEBI Listing Regulations and any other rules, regulations or guidelines as may be issued by the Government of India in connection there to and as per the recommendation by our Board of Directors and approved by our Shareholders at their discretion and will depend on a number of factors, including but not limited to earnings,

capital requirements and overall financial condition of our Company. We shall pay dividends in cash and as per provisions of the Companies Act, for further details in relation to dividends, please refer to Sections titled, “*Dividend Policy*” and “*Description of Equity Shares and Terms of the Articles of Association*”, beginning on page 139 and 228 respectively, of this draft prospectus.

FACE VALUE AND ISSUE PRICE

The face value of the share of our company is ₹ 10/- per equity share and the issue price is ₹[●] /- per equity share. The Issue Price is determined by our Company in consultation with the Lead Manager and is justified under the Section titled, “*Basis for Issue Price*”, beginning on page 69 of this draft prospectus. At any given point of time there shall be only one denomination of the Equity Shares of our Company, subject to applicable laws.

COMPLIANCE WITH SEBI (ICDR) REGULATIONS

Our Company shall comply with all requirements of the SEBI (ICDR) Regulations as amended time to time. Our Company shall comply with all disclosure and accounting norms as specified by SEBI from time to time.

RIGHTS OF THE EQUITY SHAREHOLDERS

Subject to applicable laws, rules, regulations and guidelines and the Articles of Association of our Company, the equity shareholders shall have the following rights:

- Right to receive dividend, if declared;
- Right to receive Annual Reports & notices to members;
- Right to attend general meetings and exercise voting rights, unless prohibited by law;
- Right to vote on a poll either in person or by proxy;
- Right to receive Issue for rights shares and be allotted bonus shares, if announced;
- Right to receive surplus on liquidation; subject to any statutory and other preferential claims being satisfied;
- Right of free transferability of the Equity Shares, subject to applicable law, including any RBI Rules and Regulations; and
- Such other rights, as may be available to a shareholder of a listed public company under the previous Companies Act, 1956 and Companies Act, 2013, as may be applicable, terms of the SEBI Listing Regulations and the Memorandum and Articles of Association of our Company.

For further details on the main provision of our Company’s Articles of Association dealing with voting rights, dividend, forfeiture and lien, transfer and transmission and/or consolidation/splitting, etc., please refer to Section titled, “*Description of Equity Shares and Terms of the Articles of Association*”, beginning on page 228 of this draft prospectus.

MINIMUM APPLICATION VALUE, MARKET LOT AND TRADING LOT

In terms of Section 29 of the Companies Act, 2013, the Equity Shares shall be allotted only in dematerialised form. As per the existing SEBI (ICDR) Regulations, the trading of the Equity Shares shall only be in dematerialised form for all investors. In this context, two agreements have been signed among our Company, the respective Depositories and the Registrar to the Issuer:

- Tripartite Agreement dated October 13, 2022 between NSDL, our Company and Registrar to the Issue; and
- Tripartite Agreement dated October 12, 2022 between CDSL, our Company and Registrar to the Issue.

The trading of the Equity Shares will happen in the minimum contract size of [●] Equity Shares and the same may be modified by the SME Platform of BSE from time to time by giving prior notice to investors at large.

Allocation and allotment of Equity Shares through this draft prospectus will be done in multiples of [●] Equity Shares subject to a minimum allotment of [●] Equity Shares to the successful Applicants in terms of the SEBI Circular No. CIR/MRD/DSA/06/2012 dated February 21, 2012.

MINIMUM NUMBER OF ALLOTTEES

In accordance with the Regulation 268 of SEBI ICDR Regulations, the minimum number of allottees in this Issue shall be 50 shareholders. In case the minimum number of prospective allottees is less than 50, no allotment will be made pursuant to this Issue and the monies blocked by the SCSBs shall be unblocked within 4 working days of closure of issue.

JOINT HOLDERS

Where two (2) or more persons are registered as the holders of any Equity Shares, they will be deemed to hold such Equity Shares as joint holders with benefits of survivorship.

NOMINATION FACILITY TO INVESTOR

In accordance with Section 72 of the Companies Act, 2013, the sole or first applicant, along with other joint applicant, may nominate any one person in whom, in the event of the death of sole applicant or in case of joint applicant, death of all the Applicants, as the case may be, the Equity Shares allotted, if any, shall vest. A person, being a nominee, entitled to the Equity Shares by reason of the death of the original holder(s), shall in accordance with Section 72 of the Companies Act, 2013, be entitled to the same advantages to which he or she would be entitled if he or she were the registered holder of the Equity Share(s). Where the nominee is a minor, the holder(s) may make a nomination to appoint, in the prescribed manner, any person to become entitled to Equity Share(s) in the event of his or her death during the minority. A nomination shall stand rescinded upon a sale of equity share(s) by the person nominating. A buyer will be entitled to make a fresh nomination in the manner prescribed. Fresh nomination can be made only on the prescribed form available on request at the Registered Office of our Company or to the Registrar and Transfer Agents of our Company.

In accordance with Section 72 of the Companies Act, 2013, any Person who becomes a nominee by virtue of this section shall upon the production of such evidence as may be required by the Board, elect either:

To register himself or herself as the holder of the Equity Shares; or to make such transfer of the Equity Shares, as the deceased holder could have made.

Further, the Board may at any time give notice requiring any nominee to choose either to be registered himself or herself or to transfer the Equity Shares, and if the notice is not complied with within a period of ninety (90) days, the Board may thereafter withhold payment of all dividends, bonuses or other moneys payable in respect of the Equity Shares, until the requirements of the notice have been complied with.

Since the allotment of Equity Shares in the Issue will be made only in dematerialized form, there is no need to make a separate nomination with our Company. Nominations registered with the respective depository participant of the applicant would prevail. If the investors require changing the nomination, they are requested to inform their respective depository participant.

PERIOD OF SUBSCRIPTION LIST OF PUBLIC ISSUE

ISSUE OPENS ON	[●]
ISSUE CLOSES ON	[●]

- *In terms of regulation 265 of SEBI (ICDR) Regulation, 2018, the issue shall be open after at least three working days from the date of filing the prospectus with the Registrar of Companies.*
- *In terms of regulation 266(1) of SEBI (ICDR) Regulation, 2018, Except as otherwise provided in these regulations, the public issue shall be kept open for at least three working days and not more than ten working days.*
- *In terms of regulation 266(2) of SEBI (ICDR) Regulation, 2018, In case of a revision in the price band, the issuer shall extend the bidding (issue) period disclosed in the prospectus, for a minimum period of three working days, subject to the provisions of sub-regulation (1) is not applicable to our company as this is fixed price issue.*
- *In terms of regulation 266(3) of SEBI (ICDR) Regulation, 2018, In case of force majeure, banking strike or similar circumstances, our company may, for reasons to be recorded in writing, extend the issue period disclosed in the prospectus, for a minimum period of three working days, subject to the provisions of sub-regulation 266(1).*

Application Forms and any revisions to the same will be accepted only between 10.00 a.m. to 5.00 p.m. (IST) during the Issue Period (except for the Issue Closing Date). On the Issue Closing Date, the Application Forms will be accepted only between 10.00 a.m. to 3.00 p.m. (IST) for retail and non-retail Applicants. The time for applying for Retail Individual Applicants on Issue Closing Date maybe extended in consultation with the LM, RTA and BSE SME taking into account the total number of applications received up to the closure of timings.

Due to the limitation of time available for uploading the Application Forms on the Issue Closing Date, Applicants are advised to submit their applications one (1) day prior to the Issue Closing Date and, in any case, not later than 3.00 p.m. (IST) on the Issue Closing Date. Any time mentioned in this draft prospectus is IST. Applicants are cautioned that, in the event a large number of Application Forms are received on the Issue Closing Date, as is typically experienced in public issues, some Application Forms may not get uploaded due to the lack of sufficient time. Such Application Forms that cannot be uploaded will not be considered for allocation under this Issue. Applications will be accepted only on Working Days, i.e., Monday to Friday (excluding any public holidays). Neither our Company nor the LM is liable for any failure in uploading the Application Forms due to faults in any software/hardware system or otherwise.

In accordance with SEBI ICDR Regulations, QIBs and Non-Institutional Applicants are not allowed to withdraw or lower the size of their Application (in terms of the quantity of the Equity Shares or the Application amount) at any stage. Retail Individual Applicants can revise or withdraw their Application Forms prior to the Issue Closing Date. Allocation to Retail Individual Applicants, in this Issue will be on a proportionate basis.

In case of discrepancy in the data entered in the electronic book vis-à-vis the data contained in the physical Application Form, for a particular Applicant, the details as per the file received from BSE SME may be taken as the final data for the purpose of Allotment. In case of discrepancy in the data entered in the electronic book vis-à-vis the data contained in the physical or electronic Application Form, for a particular ASBA Applicant, the Registrar to the Issue shall ask the relevant SCSBs / RTAs/ DPs / stock brokers, as the case may be, for the rectified data.

MINIMUM SUBSCRIPTION

In accordance with Regulation 260(1) of SEBI (ICDR) Regulations, this Issue is 100% underwritten, so this issue is not restricted to any minimum subscription level.

As per section 39 of the new Companies Act, if the “stated minimum amount” has not been subscribed and the sum payable on application is not received within a period of thirty (30) days from the date of issue of draft prospectus, the application money has to be returned within such period as may be prescribed.

If our Company does not receive the subscription of 100% of the Issue through this Issue Document including devolvement of Underwriters, our Company shall forthwith unblock the entire subscription amount received. If there is a delay beyond four

(4) days after our Company becomes liable to pay the amount, our Company shall pay interest prescribed under section 73 of the Companies Act, 2013 and applicable law.

The Equity Shares have not been and will not be registered, listed or otherwise qualified in any other jurisdiction outside India and may not be Issued or sold, and applications may not be made by persons in any such jurisdiction, except in compliance with the applicable laws of such jurisdiction.

ARRANGEMENTS FOR DISPOSAL OF ODD LOTS

The trading of the Equity Shares will happen in the minimum contract size of [●] equity shares in terms of the SEBI Circular No. CIR/MRD/DSA/06/2012 dated February 21, 2012. However, in terms of Regulation 261(5) of the SEBI ICDR Regulations, the Market Maker shall buy the entire shareholding of a shareholder in one lot, where value of such shareholding is less than the minimum contract size allowed for trading on the SME platform of BSE.

APPLICATION BY ELIGIBLE NRIS, FPIS/FIIS REGISTERED WITH SEBI, VCFS REGISTERED WITH SEBI AND QFIs

It is to be understood that there is no reservation for Eligible NRIs or FPIs/FIIs registered with SEBI or VCFs or QFIs. Such Eligible NRIs, QFIs, FIIs registered with SEBI will be treated on the same basis with other categories for the purpose of Allocation.

NRIs, FPIs/FIIs and foreign venture capital investors registered with SEBI are permitted to purchase shares of an Indian company in a public Issue without the prior approval of the RBI, so long as the price of the equity shares to be issued is not less than the price at which the equity shares are issued to residents. The transfer of shares between an Indian resident and a non-resident does not require the prior approval of the FIPB or the RBI, provided that (i) the activities of the investee company are under the automatic route under the foreign direct investment (“FDI”) Policy and the non-resident shareholding is within the sectoral limits under the FDI policy; and (ii) the pricing is in accordance with the guidelines prescribed by the SEBI/RBI.

The current provisions of the Foreign Exchange Management (Transfer or Issue of Security by a Person Resident outside India) Regulations, 2000, provides a general permission for the NRIs, FPIs and foreign venture capital investors registered with SEBI to invest in shares of Indian companies by way of subscription in an IPO. However, such investments would be subject to other investment restrictions under the Foreign Exchange Management (Transfer or Issue of Security by a Person Resident outside India) Regulations, 2000, RBI and/or SEBI regulations as may be applicable to such investors.

The Allotment of the Equity Shares to Non-Residents shall be subject to the conditions, if any, as may be prescribed by the Government of India/RBI while granting such approvals.

AS PER THE EXTANT POLICY OF THE GOVERNMENT OF INDIA, OCBS CANNOT PARTICIPATE IN THIS ISSUE.

As per the existing regulations, OCBS are not eligible to participate in this Issue. The RBI has however clarified in its circular,

A.P. (DIR Series) Circular No. 44, dated December 8, 2003 that OCBs which are incorporated and are not under the adverse notice of the RBI are permitted to undertake fresh investments as incorporated non-resident entities in terms of Regulation 5(1) of RBI Notification No.20/2000-RB dated May 3, 2000 under FDI Scheme with the prior approval of Government if the investment is through Government Route and with the prior approval of RBI if the investment is through Automatic Route on case by case basis. OCBs may invest in this Issue provided it obtains a prior approval from the RBI. On submission of such approval along with the Application Form, the OCB shall be eligible to be considered for share allocation.

RESTRICTIONS ON TRANSFER AND TRANSMISSION OF SHARES OR DEBENTURES AND ON THEIR CONSOLIDATION OR SPLITTING

Except for lock-in of the Pre- Issue Equity Shares and Promoter minimum contribution in the Issue as detailed in the Section titled, “*Capital Structure*”, beginning on page 53 of this draft prospectus, and except as provided in the Articles of Association of our Company, there are no restrictions on transfer and transmission and on their consolidation/splitting of Equity Shares. For further details, please refer to the Section titled, “*Description of Equity Shares and Terms of the Articles of Association*”, beginning on page 228 of this draft prospectus.

The above information is given for the benefit of the Applicants. The Applicants are advised to make their own enquiries about the limits applicable to them. Our Company and the LM do not accept any responsibility for the completeness and accuracy of the information stated hereinabove. Our Company and the LM are not liable to inform the investors of any amendments or modifications or changes in applicable laws or regulations, which may occur after the date of this draft prospectus. Applicants are advised to make their independent investigations and ensure that the number of Equity Shares Applied for do not exceed the applicable limits under laws or regulations.

OPTION TO RECEIVE EQUITY SHARES IN DEMATERIALIZED FORM

As per Section 29 of the Companies Act, 2013 and in accordance with SEBI (ICDR) Regulations, every company making public Issue shall issue securities only in dematerialized form only. Hence, the Equity Shares being Issued can be applied for in the dematerialized form only. Further, it has been decided by the SEBI that trading in securities of companies making an public Issue shall be in dematerialized form only. The Equity Shares on Allotment will be traded only on the dematerialized segment of the SME platform of BSE.

MIGRATION TO MAIN BOARD

In accordance with the BSE Circular dated November 26, 2012, our Company will have to be mandatorily listed and traded on the BSE SME for a minimum period of three years from the date of listing and only after that it can migrate to the Main Board of the BSE as per the guidelines specified by SEBI and as per the procedures laid down under Chapter IX of the SEBI ICDR Regulations.

If the paid-up Capital of our company is more than ₹ 1,000 Lakh but below ₹ 2,500 Lakh, our Company may still apply for migration to the main board if the same has been approved by a special resolution through postal ballot wherein the votes cast by the shareholders other than the Promoters in favor of the proposal amount to at least two times the number of votes cast by shareholders other than promoter shareholders against the proposal. Any company voluntarily desiring to migrate to the Main board from the SME Platform, amongst others, has to fulfill following conditions:

Eligibility Criteria	Details
Paid up capital and market capitalization	Paid-up capital of more than 10 Crores and Market Capitalisation should be minimum ₹ 25 Crores <i>(Market Capitalisation will be the product of the price (average of the weekly high and low of the closing price of the related shares quoted on the stock exchange during 3 (Three) months prior to the date of the</i>

Eligibility Criteria	Details
	<i>application) and the post issue number of equity shares.)</i>
Promoter holding	Promoter(s) shall be holding at least 20% of equity share capital of the company at the time of making application.
Financial Parameters	The applicant company should have positive operating profit (earnings before interest, depreciation and tax) from operations for at least any 2 out of 3 financial years and has positive Profit after tax (PAT) in the immediate preceding Financial Year of making the migration application to Exchange. The applicant company should have a Net worth of at least ₹ 15 crores for 2 preceding full financial years.
Track record of the company in terms of listing/ regulatory actions, etc	The applicant company is listed on SME Exchange/ Platform having nationwide terminals for atleast 3 years.
Regulatory action	No material regulatory action in the past 3 years like suspension of trading against the applicant company, promoters/promoter group by any stock Exchange having nationwide trading terminals. No Debarment of company, promoters/promoter group, subsidiary company by SEBI. No Disqualification/Debarment of directors of the company by any regulatory authority. The applicant company has not received any winding up petition admitted by a NCLT.
Public Shareholder	The applicant company shall have a minimum of 250 public shareholders as per the latest shareholding pattern.
Other parameters like No. of shareholders, utilization of funds	No proceedings have been admitted under the Insolvency and Bankruptcy Code against the applicant company and Promoting companies. No pending Defaults in respect of payment of interest and/or principal to the debenture/bond/fixed deposit holders by the applicant, promoters/promoter group /promoting company(ies), Subsidiary Companies. The applicant company shall obtain a certificate from a credit rating agency registered with SEBI with respect to utilization of funds as per the stated objective pursuant to IPO and/or further funds raised by the company, if any post listing on SME platform. The applicant company has no pending investor complaints. Cooling off period of 2 months from the date the security has come out of trade-to- trade category or any other surveillance action.

MARKET MAKING

The Equity Shares offered through this Issue are proposed to be listed on the SME Platform of BSE, wherein [●] is the Market Maker to this Issue shall ensure compulsory Market Making through the registered Market Makers of the BSE SME. For further details of the agreement entered into between our Company, the Lead Manager and the Market Maker please refer to Section titled, “*General Information- Details of the Market Making Arrangements for this Issue*”, beginning on page 46 of this draft prospectus.

NEW FINANCIAL INSTRUMENTS

There are no new financial instruments such as Deep discounted bonds, debenture, warrants, secured premium notes, etc. issued by our Company through this issue.

JURISDICTION

Exclusive jurisdiction for the purpose of this Issue is with the competent courts/authorities in *Mumbai, Maharashtra, India*.

The Equity Shares have not been and will not be registered under the U.S. Securities Act or any state securities laws in the United States, and may not be Issued or sold within the United States to, or for the account or benefit of “U.S. persons” (as defined in Regulation S), except pursuant to an exemption from or in a transaction not subject to, registration requirements of the U.S. Securities Act and applicable U.S. state Securities laws. Accordingly, the Equity Shares are only being Issued or sold outside the United States in compliance with Regulation S under the Securities Act and the applicable laws of the jurisdictions where those Issues and sales occur.

The Equity Shares have not been and will not be registered, listed or otherwise qualified in any other jurisdiction outside India and may not be Issued or sold, and applications may not be made by persons in any such jurisdiction, except in compliance with the applicable laws of such jurisdiction.

ISSUE STRUCTURE

This Issue is being made in terms of Regulation 281 of Chapter IX of the SEBI (ICDR) Regulations 2018. Further, pursuant to Regulation 281 read with Regulation 103(1) of the SEBI ICDR Regulations, our Company is eligible to undertake the Issue as our Company has not changed its name within the last one year. For further details regarding the salient features and terms of such this Issue, please refer to Sections titled, “*Terms of the Issue*” and “*Issue Procedure*”, beginning on pages 194 and 205 respectively, of this draft prospectus.

The present Issue of [●] Equity Shares at an issue price of ₹[●]/- each aggregating up to ₹1500.00 Lakhs by our Company. The Issue and the Net Issue will constitute [●]% and [●]%, respectively of the post issue paid up equity share capital of the Issuer Company.

This Issue is being made in terms of Regulation 103, 104 of Chapter IV read with Regulation 281 of Chapter IX of SEBI (ICDR) Regulations, 2018, as amended from time to time. For further details regarding the salient features and terms of such an issue please refer chapter titled “*Terms of the Issue*” and “*Issue Procedure*” on page 194 and 205 of this Draft Prospectus.

Particulars	Net Issue to Public	Market Maker Reservation Portion
Number of Equity Shares available for allocation ⁽¹⁾	Upto 15,00,000 Equity Shares	Upto [●] Equity Shares
Percentage of Issue Size available for Allocation	[●]% of the Issue Size	[●]% of the Issue Size
Basis of Allotment	Proportionate subject to minimum allotment of [●] Equity Shares and further allotment in multiples of [●] Equity Shares each. ⁽¹⁾ For further details please refer section explaining the Basis of Allotment in the GID.	Firm Allotment
Mode of Application	All the applicants shall make the application (Online or Physical) through the ASBA Process only (including UPI mechanism for Retail Investors using Syndicate ASBA).	
Mode of Allotment	Compulsorily in dematerialised form.	
Minimum Application Size	<i>For Other than Retail Individual Investors:</i> Such number of Equity Shares in multiples of [●] Equity Shares such that the Application Value exceeds ₹ 2,00,000. <i>For Retail Individuals Investors:</i> [●] Equity Shares	Upto [●] Equity Shares
Maximum Application Size	<i>For Other than Retail Individual Investors:</i> Such number of Equity Shares in multiples of [●] Equity Shares such that the Application Size does not exceed [●] Equity Shares, subject to applicable limits to the Applicant. <i>For Retail Individuals Investors:</i> Such number of Equity Shares in multiples of [●] Equity Shares such that the application value does not exceed ₹ 2,00,000.	Upto [●]Equity Shares
Trading Lot	[●] Equity Shares	[●] Equity Shares. However, the

Particulars	Net Issue to Public	Market Maker Reservation Portion
		Market Maker may buy odd lots if any in the market as required under the SEBI (ICDR) Regulations, 2018.
Who can Apply ⁽²⁾	<p><i>For Other than Retail Individual Investors:</i></p> <p>Resident Indian individuals, Eligible NRIs, HUFs (in the name of the Karta), companies, corporate bodies, scientific institutions societies and trusts.</p> <p><i>For Retail Individuals Investors:</i></p> <p>Resident Indian individuals, HUFs (in the name of the Karta) and Eligible NRIs.</p>	Market Maker
Terms of Payment ⁽³⁾	The entire Application Amount will be payable at the time of submission of the Application Form.	
Application Lot Size	[●] Equity Share and in multiples of [●] Equity Shares thereafter	

This Issue is being made in terms of Chapter IV & IX of the SEBI (ICDR) Regulations. For further details please refer to section titled “*Issue Structure*” beginning on page 202 of this draft Prospectus.

*Since present issue is a fixed price issue, the allocation in the net offer to the public category in terms of Regulation 253 (2) of the SEBI (ICDR) Regulations, 2018 shall be made as follows:

- a) Minimum fifty per cent to retail individual investors; and
- b) Remaining to: (i) individual applicants other than retail individual investors; and (ii) other investors including corporate bodies or institutions, irrespective of the number of specified securities applied for; Provided that the unsubscribed portion in either of the categories specified in (a) or (b) above may be allocated to the applicants in the other category.

Explanation: If the retails individual investor category is entitled to more than fifty per cent of the issue size on a proportionate basis, the retails individual investors shall be allocated that higher percentage.

For further information on the Allocation of Net Offer to Public, please refer to chapter titled “*The Issue*” on page no. 41 of this Draft Prospectus.

WITHDRAWAL OF THE ISSUE

Our Company, in consultation with the Lead Manager, reserves the right not to proceed with the Issue at any time before the Issue Opening Date, without assigning any reason thereof. Notwithstanding the foregoing, the Issue is also subject to obtaining the following:

- a. The final listing and trading approvals of BSE for listing of Equity Shares Issued through this Issue on its SME Platform, which the Company shall apply for after Allotment; and
- b. The final RoC approval of the prospectus after it is filed with the RoC.
- c. In case, our Company wishes to withdraw the Issue after Issue Opening but before allotment, our Company will give public notice giving reasons for withdrawal of Issue. The public notice will appear in two (2) widely circulated national newspapers (one each in English and Hindi) and one (1) in regional newspaper.

The Lead Manager, through the Registrar to the Issue, will instruct the SCSBs to unblock the ASBA Accounts within one (1) Working Day from the day of receipt of such instruction. The notice of withdrawal will be issued in the same newspapers where the pre-Issue advertisements have appeared, and the Stock Exchange will also be informed promptly. If our Company withdraws the Issue after the Issue Closing Date and subsequently

decides to undertake a public Issuing of Equity Shares, our Company will file a fresh Issue document with the stock exchange where the Equity Shares may be proposed to be listed.

Notwithstanding the foregoing, the Issue is subject to obtaining (i) the final listing and trading approvals of the Stock Exchange with respect to the Equity Shares Issued through the prospectus, which our Company will apply for only after Allotment; and (ii) the final RoC approval of the prospectus.

ISSUE PROGRAMME

Events	Indicative Dates
Issue Opening Date	[●]
Issue Closing Date	[●]
Finalisation of Basis of Allotment with BSE SME	[●]
Initiation of Allotment / Refunds/ unblocking of ASBA Accounts	[●]
Credit of Equity Shares to demat accounts of the Allottees	[●]
Commencement of trading of the Equity Shares on BSE SME	[●]

Note: The above timetable is indicative in nature and does not constitute any obligation on the Company or the Lead Manager. While our Company shall ensure that all the steps for completion of all the necessary formalities for the listing and trading of our equity shares on the SME Platform of BSE are taken within 6 working days of the issue closing date, the time table may change due to various factors such as extension of the issue period by the Company or any delay in receiving final listing and trading approval from the BSE. The Commencement of the trading of Equity shares will be entirely at the discretion of the BSE SME in accordance with the applicable laws.

Applications and any revisions to the same will be accepted only between 10:00 a.m. to 5:00 p.m. (Indian Standard Time) during the Issue Period at the Application Centres mentioned in the Application Form. On the Issue Closing Date when applications will be accepted only between 10:00 a.m. to 4:00 p.m. (Indian Standard Time).

Due to limitation of time available for uploading the application on the Issue Closing Date, Applicants are advised to submit their applications one day prior to the Issue Closing Date and, in any case, not later than 1:00 p.m. IST on the Issue Closing Date. Any time mentioned in this draft prospectus is IST. Applicants are cautioned that, in the event a large number of applications are received on the Issue Closing Date, as is typically experienced in public Issues, some applications may not get uploaded due to lack of sufficient time. Such applications that cannot be uploaded will not be considered for allocation under this Issue.

Applications will be accepted only on Working Days, i.e., Monday to Friday (excluding any public holiday)

ISSUE PROCEDURE

All Bidders should read the General Information Document for Investing in Public Issues prepared and issued in accordance with the circular no. SEBI/HO/CFD/DIL1/CIR/P/2020/37 dated March 17, 2020 and the UPI Circulars (the “**General Information Document**”), which highlights the key rules, processes and procedures applicable to public issues in general in accordance with the provisions of the Companies Act, the SCRA, the SCRR and the SEBI ICDR Regulations which is part of the abridged prospectus accompanying the Application Form. The General Information Document is available on the websites of the Stock Exchanges and the Lead Managers. Please refer to the relevant provisions of the General Information Document which are applicable to the Issue especially in relation to the process for Bids by Retail Individual Investors through the UPI Mechanism. The investors should note that the details and process provided in the General Information Document should be read along with this section.

Additionally, all Bidders may refer to the General Information Document for information in relation to (i) category of investors eligible to participate in the Issue; (ii) maximum and minimum Bid size; (iii) price discovery and allocation; (iv) payment instructions for ASBA Bidders; (v) issuance of Confirmation of Allocation Note (“CAN”) and Allotment in the Issue; (vi) general instructions (limited to instructions for completing the Application Form); (vii) designated date; (viii) disposal of applications; (ix) submission of Application Form; (x) other instructions (limited to joint bids in cases of individual, multiple bids and instances when an application would be rejected on technical grounds); (xi) applicable provisions of Companies Act relating to punishment for fictitious applications; (xii) mode of making refunds; and (xiii) interest in case of delay in Allotment or refund.

SEBI vide its circular no. SEBI/HO/CFD/DIL2/CIR/P/2018/138 dated November 1, 2018 read with its circular no. SEBI/HO/CFD/DIL2/CIR/P/2019/50 dated April 3, 2019, has introduced an alternate payment mechanism using Unified Payments Interface (“UPI”) and consequent reduction in timelines for listing in a phased manner. From January 1, 2019, the UPI Mechanism for Retail Individual Investors applying through Designated Intermediaries was made effective along with the existing process and existing timeline of T+6 days. (“**UPI Phase I**”). The UPI Phase I was effective till June 30, 2019.

With effect from July 1, 2019, SEBI vide its circular no. SEBI/HO/CFD/DIL2/CIR/P/2019/76 dated June 28, 2019, read with circular bearing number SEBI/HO/CFD/DIL2/CIR/P/2019/85 dated July 26, 2019 with respect to Bids by Retail Individual Investors through Designated Intermediaries (other than SCSBs), the existing process of physical movement of forms from such Designated Intermediaries to SCSBs for blocking of funds has been discontinued and only the UPI Mechanism for such Bids with existing timeline of T+6 days was mandated for a period of three months or launch of five main board public issues, whichever is later (“**UPI Phase II**”). However, given the prevailing uncertainty due to the COVID-19 pandemic, SEBI vide its circular no. SEBI/HO/CFD/DIL2/CIR/P/2020/50 dated March 30, 2020, has decided to **continue with the UPI Phase II till further notice**. The final reduced timeline will be made effective using the UPI Mechanism for applications by Retail Individual Investors (“**UPI Phase III**”), as may be prescribed by SEBI. The Issue will be undertaken pursuant to the processes and procedures under UPI Phase II, subject to any circulars, clarification or notification issued by the SEBI from time to time.

SEBI vide Circular No. SEBI/HO/CFD/DIL2/CIR/P/2021/2480/1/M dated March 16, 2021, which came into effect from May 01, 2021 had put in place measures to have a uniform policy to further streamline the processing of ASBA applications through UPI process among intermediaries/SCSBs and also provided a mechanism of compensation to investors.

However, in view of the representations received from stakeholders, SEBI vide Circular no: SEBI/HO/CFD/DIL2/P/CIR/2021/570 dated June 02, 2021 given some relaxation for the implementation timelines for the provisions of “the circular” which are as under:

- **SMS Alerts:** Para 9 of “the circular” prescribed the details to be sent by SCSB’s in SMS alerts. While SCSB’s shall continue to send SMS alerts during the actual block/debit/unblock of UPI mandate in the prescribed format, the details of total number of shares applied/allotted/non-allotted etc shall be included in SMS for Public Issues opening on/after January 01, 2022.
- **Web Portal for CUG:** For ease of doing business, Para 10 of “the circular” prescribed a web portal to be

hosted by Sponsor Banks for closed user group (hereinafter referred to as “CUG”) entities. In view of the representations received from the stakeholders, it has been decided that:

- ❖ The automated web portal shall be live and operational after due testing and mock trials with the CUG entities for Public Issues opening on or after October 01, 2021. The requisite information on this automated portal shall be updated periodically in intervals not exceeding two hours.
 - ❖ In the interim, for the Public Issues opening from the date of this circular and till the automated web portal is live and operational, the Sponsor Banks shall send the details prescribed in Para 10 of “the circular” to the e-mail address of CUG entities periodically in intervals not exceeding three hours. In case of exceptional events viz., technical issues with UPI handles/PSPs/TPAPS/SCSB’s etc, the same shall be intimated immediately to the CUG entities so as to facilitate the flow of information in the Public Issue process.
 - ❖ The Stock Exchanges and Lead Managers shall facilitate providing the requisite data of CUG entities to Sponsor Bank for the development of automated web portal. Such information shall be provided to the Sponsor Bank before opening of the Public Issue.
- **Completion of Unblocks by T+4:** Para 13 of “the circular” prescribed the process and timeline for ensuring the completion of unblocks pertaining to UPI mandates on T+4 (T: Issue Closing Date). while the process of unblocking shall be completed by T+4, in view of the representations received from stakeholders, the following shall be the revised timelines:
- ❖ The Registrar to the Issue shall provide the allotment/ revoke files to the Sponsor Bank by 8:00 PM on T+3 i.e., the day when the Basis of Allotment (BOA) has to be finalized.
 - ❖ The Sponsor Bank shall execute the online mandate revoke file for Non-Allottees/ Partial Allottees and provide pending applications for unblock, if any, to the Registrar to the Issue, not later than 5:00 PM on BOA+1.
 - ❖ Subsequent to the receipt of the pending applications for unblock from the Sponsor Bank, the Registrar to the Issue shall submit the bank-wise pending UPI applications for unblock to the SCSBs, not later than 6:30 PM on BOA+1.
 - ❖ To ensure that the unblocking is completed on T+4, the Lead Managers, on a continuous basis and before the opening of the public issue shall take up the matter with the SCSB’s at appropriate level.

In case of any delay in unblocking of amounts in the ASBA Accounts (including amounts blocked through the UPI Mechanism) exceeding 4 (four) Working Days from the Issue Closing Date, the Applicant shall be compensated at a uniform rate of Rs.100 per day for the entire duration of delay exceeding four Working Days from the Issue Closing Date by the intermediary responsible for causing such delay in unblocking. The LM shall, in their sole discretion, identify and fix the liability on such intermediary or entity responsible for such delay in unblocking. Further, SEBI vide its circular no. SEBI/HO/CFD/DIL1/CIR/P/2021/47 dated March 31, 2021, has reduced the timelines for refund of Application money to four days.

Our Company and the LM do not accept any responsibility for the completeness and accuracy of the information stated in this section and the General Information Document and are not liable for any amendment, modification or change in the applicable law which may occur after the date of this Draft Prospectus. Bidders are advised to make their independent investigations and ensure that their Bids are submitted in accordance with applicable laws and do not exceed the investment limits or maximum number of the Equity Shares that can be held by them under applicable law or as specified in this Draft Prospectus. Further, our Company and the LM are not liable for any adverse occurrences consequent to the implementation of the UPI Mechanism for application in this Issue.

Phased implementation of Unified Payments Interface (UPI)

SEBI has issued the various UPI Circulars in relation to streamlining the process of public issue of inter alia, equity shares. Pursuant to the UPI Circulars, the UPI Mechanism has been introduced in a phased manner as a payment mechanism (in addition to mechanism of blocking funds in the account maintained with SCSBs under ASBA) for applications by Retail Individual Investors through Designated Intermediaries with the objective to reduce the time duration from public issue closure to listing from six Working Days to up to three Working Days. Considering the time required for making necessary changes to the systems and to ensure complete and smooth transition to the UPI payment mechanism, the UPI Circulars have introduced the UPI Mechanism in three phases in the following manner:

Phase I: This phase was applicable from January 1, 2019 until March 31, 2019 or floating of five main board public issues, whichever was later. Subsequently, the timeline for implementation of Phase I was extended till June 30, 2019. Under this phase, a Retail Individual Investor had the option to submit the ASBA Form with any of the Designated Intermediary and use his/her UPI ID for the purpose of blocking of funds. The time duration from public issue closure to listing continued to be six Working Days.

Phase II: This phase has become applicable from July 1, 2019. SEBI vide its circular no. SEBI/HO/CFD/DCR2/CIR/P/2019/133 dated November 8, 2019 had extended the timeline for implementation of UPI Phase II till March 31, 2020. Further, SEBI vide its circular no. SEBI/HO/CFD/DIL2/CIR/P/2020 dated March 30, 2020 decided to continue Phase II of UPI with ASBA until further notice. Under this phase, submission of the ASBA Form by Retail Individual Investors through Designated Intermediaries (other than SCSBs) to SCSBs for blocking of funds will be discontinued and will be replaced by the UPI Mechanism. However, the time duration from public issue closure to listing would continue to be six Working Days during this phase.

Phase III: The commencement period of Phase III is yet to be notified. In this phase, the time duration from public issue closure to listing is proposed to be reduced to three Working Days. For further details, refer to the General Information Document available on the websites of the Stock Exchanges and the Managers.

FIXED PRICE ISSUE PROCEDURE

The Issue is being made in compliance with the provisions of Chapter IX of the SEBI ICDR Regulations pursuant to Regulation 281 read with Regulation 103(1) and Regulation 229(1), and through the Fixed Price Process wherein 50% of the Net Issue to Public is being offered to the Retail Individual Applicants and the balance is being offered to Other Investors including QIBs and Non-Institutional Applicants.

However, in case of under-subscription in either category, unsubscribed portion shall be allocated to investors in other category subject to valid Applications being received from them at the Issue Price.

Subject to the valid Applications being received at the Issue Price, allotment to all categories in the Net Issue, shall be made on a proportionate basis, except for the Retail Individual Investors Category where Allotment to each Retail Individual Applicants shall not be less than the minimum lot, subject to availability of Equity Shares in Retail Individual Investors Category, and the remaining available Equity Shares, if any, shall be allotted on a proportionate basis. Under subscription, if any, in any category, would be allowed to be met with spill over from any other category or a combination of categories at the discretion of our Company in consultation with the Lead Manager and the Stock Exchange.

The Equity Shares on Allotment shall be traded only in the dematerialised segment of the Stock Exchanges. Investors should note that the Equity Shares will be Allotted to all successful Applicants only in dematerialised form. It is mandatory to furnish the details of Applicant's depository account along with Application Form. The Application Forms which do not have the details of the Applicants' depository account, including the DP ID Numbers and the beneficiary account number shall be treated as incomplete and rejected. Application Forms which do not have the details of the Applicants' PAN, (other than Applications made on behalf of the Central and the State Governments, residents of the state of Sikkim and official appointed by the courts) shall be treated as incomplete and are liable to be rejected. Applicants will not have the option of being Allotted Equity Shares in physical form. The Equity Shares on Allotment shall be traded only in the dematerialised segment of the Stock Exchanges.

APPLICATION FORM

Application Forms will be available with the Syndicate/sub-Syndicate members, SCSBs and at our Registered Office. In addition, the Application Forms will also be available for download on the website of the Company, Lead Manager and Stock Exchange, BSE (www.bseindia.com), at least one day prior to the Issue Opening Date.

All Bidders (other than Anchor Investors) shall mandatorily participate in the Issue only through the ASBA process. The Retail Individual Investors can additionally Bid through the UPI Mechanism.

All ASBA Bidders must provide either, (i) bank account details and authorizations to block funds in the ASBA Form; or (ii) the UPI ID (in case of Retail Individual Investors), as applicable, in the relevant space provided

in the ASBA Form and the ASBA Forms that do not contain such details will be rejected. Applications made by the Retail Individual Investors using third party bank account or using third party linked bank account UPI ID are liable for rejection. Retail Individual Investors bidding using the UPI Mechanism must provide the valid UPI ID in the relevant space provided in the Application Form and the Application Form that does not contain the UPI ID are liable to be rejected.

Applicants shall ensure that the Applications are made on Application Forms bearing the stamp of a member of the Syndicate or the Registered Broker or the SCSBs or Registrars to an Issue and Share Transfer Agents or Depository Participants, as the case may be, submitted at the Collection centres only (except in case of electronic Application Forms) and the Application Forms not bearing such specified stamp are liable to be rejected.

The prescribed colour of the Application Form for various categories applying in this issue is as follows:

Category	Colour
Resident Indians and Eligible NRIs applying on a non-repatriation basis (ASBA)**	White*
Non-Residents and Eligible NRIs applying on a repatriation basis (ASBA)**	Blue*

* Excluding electronic Application Form.

** Application forms will also be available on the website of the BSE (www.bseindia.com). Same Application Form applies to all ASBA Applicants/ Retail Individual Applicants applying through UPI mechanism, irrespective of whether they are submitted to the SCSBs, to the Registered Brokers, to Registrars to an Issue and Share Transfer Agents, Depository Participants or to the Syndicate (in Specified Cities).

In case of ASBA Forms, Designated Intermediaries shall upload the relevant bid details in the electronic bidding system of the Stock Exchanges.

Subsequently, for ASBA Forms (other than Retail Individual Investors using UPI Mechanism), Designated Intermediaries (other than SCSBs) shall submit / deliver the ASBA Forms to the respective SCSB where the Bidder has an ASBA bank account and shall not submit it to any non-SCSB bank or any Escrow Collection Bank. Stock Exchanges shall validate the electronic bids with the records of the CDP for DP ID/Client ID and PAN, on a real time basis and bring inconsistencies to the notice of the relevant Designated Intermediaries, for rectification and re-submission within the time specified by

Stock Exchanges. Stock Exchanges shall allow modification of either DP ID/Client ID or PAN ID, bank code and location code in the Bid details already uploaded.

For Retail Individual Investors using UPI Mechanism, the Stock Exchanges shall share the Bid details (including UPI ID) with the Sponsor Bank on a continuous basis through API integration to enable the Sponsor Bank to initiate UPI Mandate Request to Retail Individual Investors for blocking of funds. The Sponsor Bank shall initiate request for blocking of funds through NPCI to Retail Individual Investors, who shall accept the UPI Mandate Request for blocking of funds on their respective mobile applications associated with UPI ID linked bank account. The NPCI shall maintain an audit trail for every Bid entered in the Stock Exchanges bidding platform, and the liability to compensate Retail Individual Investors (Bidding through UPI Mechanism) in case of failed transactions shall be with the concerned entity (i.e. the Sponsor Bank, NPCI or the issuer bank) at whose end the lifecycle of the transaction has come to a halt. The NPCI shall share the audit trail of all disputed transactions/investor complaints to the Sponsor Banks and the issuer bank. The Sponsor Banks and the Bankers to the Issue shall provide the audit trail to the LM for analysing the same and fixing liability.

The Sponsor Bank will undertake a reconciliation of Bid responses received from Stock Exchanges and sent to NPCI and will also ensure that all the responses received from NPCI are sent to the Stock Exchanges platform with detailed error code and description, if any. Further, the Sponsor Bank will undertake reconciliation of all Bid requests and responses throughout their lifecycle on daily basis and share reports with the LM in the format and within the timelines as specified under the UPI Circulars. Sponsor Bank and issuer banks shall download UPI settlement files and raw data files from the NPCI portal after every settlement cycle and do a three-way reconciliation with UPI switch data, CBS data and UPI raw data. NPCI is to coordinate with issuer banks and Sponsor Banks on a continuous basis.

WHO CAN APPLY?

Each Applicant should check whether it is eligible to apply under applicable law. Furthermore, certain categories of Applicants, such as NRIs, FPIs and FVCIs may not be allowed to apply in the Issue or to hold Equity Shares, in excess of certain limits specified under applicable law. Applicants are requested to refer to the Application Form and GID for more details.

Subject to the above, an illustrative list of Applicants is as follows:

- i. Indian nationals resident in India who are competent to contract under the Indian Contract Act, 1872, in single or joint names (not more than three);
- ii. Applications belonging to an account for the benefit of a minor (under guardianship);
- iii. Hindu Undivided Families or HUFs, in the individual name of the Karta. The Applicant should specify that the Application is being made in the name of the HUF in the Application Form as follows: "Name of sole or first Applicant: XYZ Hindu Undivided Family applying through XYZ, where XYZ is the name of the Karta". Application by HUFs will be considered at par with Applications from individuals;
- iv. Companies, corporate bodies and societies registered under applicable law in India and authorised to invest in equity shares;
- v. QIBs;
- vi. NRIs on a repatriation basis or on a non-repatriation basis subject to applicable law;
- vii. Qualified Foreign Investors subject to applicable law;
- viii. Indian Financial Institutions, regional rural banks, co-operative banks (subject to RBI regulations and the SEBI ICDR Regulations and other laws, as applicable);
- ix. Trusts/ societies registered under the Societies Registration Act, 1860, or under any other law relating to trusts/ societies and who are authorised under the irrespective constitutions to hold and invest in equity shares;
- x. Limited liability partnerships registered under the Limited Liability Partnership Act, 2008;
- xi. Insurance companies registered with IRDAI;
- xii. Mutual Funds registered with SEBI;
- xiii. FPIs other than Category III Foreign Portfolio Investor;
- xiv. Category III Foreign Portfolio Investors, which are foreign corporates or foreign individuals only under the Other Investors Category;
- xv. Scientific and/ or industrial research organizations authorised in India to invest in the Equity Shares; and
- xvi. Any other person eligible to Apply in this Issue, under the laws, rules, regulations, guidelines and policies applicable to them.

Applications should not be made by:

- i. Minors (except through their Guardians)
- ii. Partnership firms or their nominations
- iii. Foreign Nationals (except NRIs)
- iv. Overseas Corporate Bodies

As per the existing regulations, OCBs are not eligible to participate in this Issue. The RBI has however clarified in its circular,

A.P. (DIR Series) Circular No. 44, dated December 8, 2003 that OCBs which are incorporated and are not under the adverse notice of the RBI are permitted to undertake fresh investments as incorporated non-resident entities in terms of Regulation 5(1) of RBI Notification No.20/2000-RB dated May 3, 2000 under FDI Scheme with the prior approval of Government if the investment is through Government Route and with the prior approval of RBI if the investment is through Automatic Route on case by case basis. OCBs may invest in this Issue provided it obtains a prior approval from the RBI. On submission of such approval along with the Application Form, the OCB shall be eligible to be considered for share allocation.

The Equity Shares have not been and will not be registered under the U.S. Securities Act, 1933 (the "U.S. Securities Act") or the securities laws of any state of the United States and may not be offered or sold within the United States, except pursuant to an exemption from, or in a transaction not subject to, the registration requirements of the U.S. Securities Act and applicable state securities laws. Accordingly, the Equity Shares are being offered and sold only outside the United States in offshore transactions in reliance on Regulation S under the U.S. Securities Act and the applicable laws of the jurisdiction where those offers, and sales occur.

The Equity Shares have not been and will not be registered, listed or otherwise qualified in any other jurisdiction outside India and may not be offered or sold, and Applications may not be made by persons in any such jurisdiction, except in compliance with the applicable laws of such jurisdiction.

The information below is given for the benefit of the applicants. Our Company, and the Lead Manager do not accept responsibility for the completeness and accuracy of the information stated. Our Company, and the Lead Manager is not liable for any amendments or modification or changes in applicable laws or regulations, which may occur after the date of the draft prospectus. Applicants are advised to make their independent investigations and ensure that the number of Equity Shares applied for does not exceed the limits prescribed under laws or regulations.

MAXIMUM AND MINIMUM APPLICATION SIZE:

1. For Retail Individual Applicants:

The Application must be for a minimum of [●] Equity Shares and in multiples of [●] Equity Shares thereafter, so as to ensure that the Application Price payable by the Applicant does not exceed Rs 2,00,000. In case of revision of Applications, the Retail Individual Applicants have to ensure that the Application Price does not exceed Rs 2,00,000. As the application price payable by the Retail Individual Applicants cannot exceed Rs. 2,00,000, they can make Application only for minimum Application size i.e. for [●] Equity Shares.

2. For Other than Retail Individual Applicants (Non-Institutional Applicants and QIBs):

The Application must be for a minimum of such number of Equity Shares that the Application Amount exceeds Rs 2,00,000 and in multiples of [●] Equity Shares thereafter. An Application cannot be submitted for more than the Net Issue Size. However, the maximum Application by a QIB investor should not exceed the investment limits prescribed for them by applicable laws. Under existing SEBI Regulations, a QIB Applicant cannot withdraw its Application after the Issue Closing Date and is required to pay 100% QIB Margin upon submission of Application.

In case of revision in Applications, the Non-Institutional Applicants, who are individuals, have to ensure that the Application Amount is greater than Rs 2,00,000 for being considered for allocation in the Non-Institutional Portion.

3. Minimum Bid Lot: [●] Equity Shares

BASIS OF ALLOTMENT

Allotment will be made in consultation with the Designated Stock Exchange. In the event of oversubscription, the allotment will be made on a proportionate basis in marketable lots as set forth here:

- a) The total number of Shares to be allocated to each category as a whole shall be arrived at on a proportionate basis i.e., the total number of Shares applied for in that category multiplied by the inverse of the over subscription ratio (number of applicants in the category X number of Shares applied for).
- b) The number of Shares to be allocated to the successful applicants will be arrived at on a proportionate basis in marketable lots (i.e., Total number of Shares applied for into the inverse of the over subscription ratio).
- c) For applications where the proportionate allotment works out to less than [●] Equity Shares the allotment will be made as follows:
 - i. Each successful applicant shall be allotted [●] Equity Shares;
 - ii. The successful applicants out of the total applicants for that category shall be determined by the draw of lots in such a manner that the total number of Shares allotted in that category is equal to the number of Shares worked out as per (2) above.
- d) If the proportionate allotment to an applicant works out to a number that is not a multiple of [●] Equity Shares, the applicant would be allotted Shares by rounding off to the lower nearest multiple of [●] Equity Shares subject to a minimum allotment of [●] Equity Shares.

- e) If the Shares allotted on a proportionate basis to any category is more than the Shares allotted to the applicants in that category, the balance available Shares for allocation shall be first adjusted against any category, where the allotted Shares are not sufficient for proportionate allotment to the successful applicants in that category, the balance Shares, if any, remaining after such adjustment will be added to the category comprising of applicants applying for the minimum number of Shares. If as a result of the process of rounding off to the lower nearest multiple of [●] Equity Shares, results in the actual allotment being higher than the shares offered, the final allotment may be higher at the sole discretion of the Board of Directors, upto 110% of the size of the offer specified under the Capital Structure mentioned in this Draft Prospectus.
- f) The above proportionate allotment of shares in an Issue that is oversubscribed shall be subject to the reservation for Retail Individual applicants as described below:
- As per Regulation 253(2) of the SEBI (ICDR) Regulations 2018, as the Retail Individual Investor category is entitled to minimum fifty percent on proportionate basis, the retail individual investors shall be allocated that higher percentage.
 - Remaining to Individual applicants other than retail individual investors and other investors including corporate bodies or institutions, irrespective of the number of specified securities applied for;
 - The unsubscribed portion in either of the categories specified in (i) or (ii) above may be available for allocation to the applicants in the other category, if so required.

“Retail Individual Investor” means an investor who applies for shares of value of not more than ₹2,00,000/-. Investors may note that in case of over subscription allotment shall be on proportionate basis and will be finalized in consultation with the designated stock exchange.

The Executive Director/Managing Director of the Designated Stock Exchange in addition to Lead Manager and Registrar to the Public Issue shall be responsible to ensure that the basis of allotment is finalized in a fair and proper manner in accordance with the SEBI (ICDR) Regulations, 2018.

PARTICIPATION BY ASSOCIATES /AFFILIATES OF LM AND THE SYNDICATE MEMBERS

The LM, Market Maker and the Underwriter, if any shall not be entitled to subscribe to this Issue in any manner except towards fulfilling their underwriting and market making obligations. However, associates/affiliates of the LM and Syndicate Members, if any may subscribe for Equity Shares in the Issue, either in the QIB Category or in the Non- Institutional Category as may be applicable to the Applicants, where the allocation is on a proportionate basis and such subscription may be on their own account or on behalf of their clients.

APPLICATION BY MUTUAL FUNDS

As per the current regulations, the following restrictions are applicable for investments by Mutual fund:

No mutual fund scheme shall invest more than 10% of its net asset value in the Equity Shares or equity related instruments of any Company provided that the limit of 10% shall not be applicable for investments in index funds or sector or industry specific funds. No mutual fund under all its schemes should own more than 10% of any Company's paid up share capital carrying voting rights.

With respect to Applications by Mutual Funds, a certified copy of their SEBI registration certificate must be lodged with the Application Form. Failing this, our Company reserves the right to accept or reject any Application in whole or in part, in either case, without assigning any reason thereof.

In case of a Mutual Fund, a separate Application can be made in respect of each scheme of the Mutual Fund registered with SEBI and such Applications in respect of more than one scheme of the Mutual Fund will not be treated as multiple Applications provided that the Applications clearly indicate the scheme concerned for which the Application has been made.

The Application made by Asset Management Companies or custodians of Mutual Funds shall specifically state the names of the concerned schemes for which the Applications are made.

APPLICATIONS BY ELIGIBLE NRIS

Only Applications accompanied by payment in Indian Rupees or freely convertible foreign exchange will be considered for Allotment. Eligible NRIs intending to make payment through freely convertible foreign exchange and Applying on a repatriation basis could make payments through the ASBA process only by blocking the funds for the amount payable on application in their NRE Account or FCNR Accounts, maintained with banks authorised by the RBI to deal in foreign exchange.

Eligible NRIs applying on a repatriation basis are advised to use the Application Form meant for Non-Residents, accompanied by a bank certificate confirming that the payment has been made by blocking the relevant funds in their NRE or FCNR account, as the case may be. Payment for Application by non-resident Applicants applying on a repatriation basis will not be accepted out of NRO accounts for the full Application amount, at the time of submission of the Application Form.

Eligible NRIs applying on non-repatriation basis are advised to use the Application Form for residents (white in colour). Eligible NRIs applying on a repatriation basis are advised to use the Application Form meant for Non-Residents (blue in colour).

APPLICATIONS BY HUF

Application by Hindu Undivided Families or HUFs should be in the individual name of the Karta. The Applicant should specify that the Application is being made in the name of the HUF in the Application Form as follows: “Name of sole or first Applicant: XYZ Hindu Undivided Family applying through XYZ, where XYZ is the name of the Karta”. Application by HUFs will be considered at par with Applications by individuals.

APPLICATIONS BY FPI'S

In terms of the SEBI FPI Regulations, the issue of Equity Shares to a single FPI or an investor group (which means the same set of ultimate beneficial owner(s) investing through multiple entities) is not permitted to exceed 10% of our post-Issue Equity Share capital. Further, in terms of the FEMA Regulations, the total holding by each FPI shall be below 10% of the total paid-up Equity Share capital of our Company and the total holdings of all FPIs put together shall not exceed 24% of the paid-up Equity Share capital of our Company. The aggregate limit of 24% may be increased upto the sectoral cap by way of a resolution passed by the Board of Directors followed by a special resolution passed by the Shareholders of our Company and subject to prior intimation to the RBI.

In case the total holding of an FPI increases beyond 10% of the total paid-up Equity Share capital of our Company, on a fully diluted basis or 10% or more of the paid-up value of any series of debentures or preference shares or share warrants issued that may be issued by our Company, the total investment made by the FPI will be re-classified as FDI subject to the conditions as specified by SEBI and the RBI in this regard and our Company and the investor will be required to comply with applicable reporting requirements.

FPIs are permitted to participate in the Issue subject to compliance with conditions and restrictions which may be specified by the Government from time to time.

Subject to compliance with all applicable Indian laws, rules, regulations, guidelines and approvals in terms of Regulation 22 of the SEBI FPI Regulations, an FPI, other than Category III foreign portfolio and unregulated broad based funds, which are classified as Category II foreign portfolio investor by virtue of their investment manager being appropriately regulated, may issue or otherwise deal in offshore derivative instruments (as defined under the SEBI FPI Regulations as any instrument, by whatever name called, which is issued overseas by a FPI against securities held by it that are listed or proposed to be listed on any recognized stock exchange in India, as its underlying) directly or indirectly, only in the event (i) such offshore derivative instruments are issued only to persons who are regulated by an appropriate regulatory authority; and (ii) such offshore derivative instruments are issued after compliance with ‘know your client’ norms. An FPI is also required to ensure that no further issue or transfer of any offshore derivative instrument is made by or on behalf of it to any persons that are not regulated by an appropriate foreign regulatory authority. In case of Applications made by FPIs, a verified true copy of the certificate of registration issued by the designated depository participant under the FPI Regulations is required to be attached along with the Application form, failing which our Company reserves the right to reject the Application without assigning any reasons thereof.

APPLICATIONS BY BANKING COMPANIES

In case of Applications made by banking companies registered with the RBI, certified copies of: (i) the certificate of registration issued by the RBI, and (ii) the approval of such banking company's investment committee are required to be attached to the Application Form, failing which our Company reserves the right to reject any Application by a banking company without assigning any reason therefor.

The investment limit for banking companies in non-financial services companies as per the Banking Regulation Act, 1949, as amended (the "Banking Regulation Act"), and the Reserve Bank of India (Financial Services provided by Banks) Directions, 2016, is 10% of the paid-up share capital of the investee company, not being its subsidiary engaged in non-financial services, or 10% of the bank's own paid-up share capital and reserves, whichever is lower. However, a banking company would be permitted to invest in excess of 10% but not exceeding 30% of the paid-up share capital of such investee company if (i) the investee company is engaged in non-financial activities permitted for banks in terms of Section 6(1) of the Banking Regulation Act, or (ii) the additional acquisition is through restructuring of debt/corporate debt restructuring/strategic debt restructuring, or to protect the bank's interest on loans/investments made to a company. The bank is required to submit a timebound action plan for disposal of such shares within a specified period to the RBI. A banking company would require a prior approval of the RBI to make (i) investment in a subsidiary and a financial services company that is not a subsidiary (with certain exceptions prescribed), and (ii) investment in a non-financial services company in excess of 10% of such investee company's paid-up share capital as stated in 5(a)(v)(c)(i) of the Reserve Bank of India (Financial Services provided by Banks) Directions, 2016.

APPLICATIONS BY SCSB'S

SCSBs participating in the Issue are required to comply with the terms of the SEBI circulars dated September 13, 2012 and January 2, 2013. Such SCSBs are required to ensure that for making applications on their own account using ASBA, they should have a separate account in their own name with any other SEBI registered SCSBs. Further, such account shall be used solely for the purpose of making application in public issues and clear demarcated funds should be available in such account for ASBA applications.

APPLICATIONS BY SEBI REGISTERED VENTURE CAPITAL FUNDS, ALTERNATIVE INVESTMENT FUNDS AND FOREIGN VENTURE CAPITAL INVESTORS

The SEBI VCF Regulations and the SEBI FVCI Regulations, as amended, inter alia prescribe the investment restrictions on VCFs and FVCIs, respectively, registered with SEBI. Further, the SEBI AIF Regulations prescribe, amongst others, the investment restrictions on AIFs.

Accordingly, the holding in any company by any individual VCF or FVCI registered with SEBI should not exceed 25% of the corpus of the VCF or FVCI. Further, VCFs and FVCIs can invest only upto 33.33% of the investible funds in various prescribed instruments, including in public offerings.

The category I and II AIFs cannot invest more than 25% of the corpus in one investee company. A category III AIF cannot invest more than 10% of the corpus in one investee company. A venture capital fund registered as a category I AIF, as defined in the SEBI AIF Regulations, cannot invest more than 1/3rd of its corpus by way of subscription to a public offering of a venture capital undertaking. Additionally, the VCFs which have not re-registered as an AIF under the SEBI AIF Regulations shall continue to be regulated by the VCF Regulations.

All Non-Resident Applicants including Eligible NRIs, FIIs and FVCIs should note that refunds, dividends and other distributions, if any, will be payable in Indian Rupees only and net of bank charges and / or commission. There is no reservation for Eligible NRIs, FIIs and FVCIs and all Applicants will be treated on the same basis with other categories for the purpose of allocation.

Further, according to the SEBI Regulations, the shareholding of VCFs, category I or II AIFs and FVCIs held in a company prior to making a public offering would be exempt from lock-in requirements only if the shares have been held by them for at least one year prior to the time of filing the draft prospectus with SEBI. However, such equity shares shall be locked in for a period of at least one year from the date of purchase by the VCF, category I or II AIF or FVCI, as the case may.

-

APPLICATIONS BY LIMITED LIABILITY PARTNERSHIPS

In case of Applications made by limited liability partnerships registered under the Limited Liability Partnership Act, 2008, a certified copy of certificate of registration issued under the Limited Liability Partnership Act, 2008, must be attached to the Application Form. Failing this, our Company reserves the right to reject any Application without assigning any reason thereof.

APPLICATIONS BY INSURANCE COMPANIES

In case of Applications made by Insurance Companies, a certified copy of certificate of registration issued by IRDA must be attached to the Application Form. Failing this, our Company reserves the right to reject any Application without assigning any reason thereof.

The exposure norms for insurers, prescribed under the Insurance Regulatory and Development Authority (Investment) Regulations, 2016 (the “IRDAI Investment Regulations”) are broadly set forth below:

- a) Equity shares of a company: the lower of 10% of the outstanding Equity Shares (face value) or 10% of the respective fund in case of life insurer or 10% of investment assets in case of general insurer or reinsurer;
- b) The entire group of the investee company: not more than 15% of the respective fund in case of a life insurer or 15% of investment assets in case of a general insurer or reinsurer or 15% of the investment assets in all companies belonging to the group, whichever is lower; and
- c) The industry sector in which the investee company belong to not more than 15% of the fund of a life insurer or a general insurer or a reinsurer or 15% of the investment asset, whichever is lower.

The maximum exposure limit, in the case of an investment in equity shares, cannot exceed the lower of an amount of 10% of the investment assets of a life insurer or general insurer and the amount calculated under points (i), (ii) and (iii) above, as the case may be.

The above limit of 10.00% shall stand substituted as 15.00% of outstanding equity shares (face value) for insurance companies with investment assets of ₹2,500,000 million or more and 12.00% of outstanding equity shares (face value) for insurers with investment assets of ₹500,000.00 million or more but less than ₹2,500,000.00 million.

Insurance companies participating in this Issue, shall comply with all applicable regulations, guidelines and circulars issued by IRDA from time to time.

APPLICATIONS BY PROVIDENT FUNDS/ PENSION FUNDS

In case of Applications made by provident funds/ pension funds, subject to applicable laws, with minimum corpus of ₹ 250 million, a certified copy of certificate from a chartered accountant certifying the corpus of the provident fund/ pension fund must be attached to the Application Form. Failing this, our Company reserves the right to reject any Application, without assigning any reason thereof.

APPLICATIONS UNDER POWER OF ATTORNEY

In case of Applications made pursuant to a power of attorney or by limited companies, corporate bodies, registered societies, Mutual Funds, Eligible FPIs, insurance companies Systemically Important Non-Banking Financial Companies, insurance funds set up by the army, navy or air force of the India, insurance funds set up by the Department of Posts, India or the National Investment Fund and provident funds with a minimum corpus of ₹ 250 million and pension funds with a minimum corpus of ₹ 250 million (in each case, subject to applicable law and in accordance with their respective constitutional documents), a certified copy of the power of attorney or the relevant resolution or authority, as the case may be, along with a certified copy of the memorandum of association and articles of association and/ or bye laws, as applicable must be lodged along with the Application Form. Failing this, our Company reserves the right to accept or reject any such Application without assigning any reasons therefor.

APPLICATIONS BY SYSTEMICALLY IMPORTANT NON-BANKING FINANCIAL COMPANIES

In case of Application by Systemically Important Non-Banking Financial Companies, certified copy of a) the certificate of registration issued by RBI, b) certified copy of its latest audited financial statement on a standalone basis and a net worth certificate from its statutory auditor and c) such other approval as may be required by Systemically Important Non-Banking Financial Companies are required to be attached to the Application Form. Failing this, our Company reserves the right to accept or reject any such Application without assigning any reasons therefor. Systemically Important Non-Banking Financial Companies participating in this Issue shall comply with all applicable regulations, guidelines and circulars issued by RBI from time to time.

The above information is given for the benefit of the Applicants. Our Company and the Lead Manager are not liable for any amendments or modification or changes in applicable laws or regulations, which may occur after the date of this draft prospectus. Applicants are advised to make their independent investigations and Applicants are advised to ensure that any single Application from them does not exceed the applicable investment limits or maximum number of Equity Shares that can be held by them under applicable law or regulation or as specified in this draft prospectus.

METHOD AND PROCESS OF APPLICATIONS

1. The Designated Intermediaries shall accept applications from the Applicants during the Issue Period.
2. The Issue Period shall be for a minimum of three Working Days and shall not exceed 10 Working Days. The Issue Period may be extended, if required, by an additional three Working Days, subject to the total Issue Period not exceeding 10 Working Days.
3. During the Issue Period, Applicants who are interested in subscribing to the Equity Shares should approach the Designated Intermediaries to register their applications.
4. The Applicant cannot apply on another Application Form after applications on one Application Form have been submitted to the Designated Intermediaries. Submission of a second Application form to either the same or to another Designated Intermediaries will be treated as multiple applications and is liable to be rejected either before entering the application into the electronic collecting system or at any point prior to the allocation or Allotment of Equity Shares in this Issue.
5. Designated Intermediaries accepting the application forms shall be responsible for uploading the application along with other relevant details in application forms on the electronic bidding system of stock exchange and submitting the form to SCSBs for blocking of funds (except in case of SCSBs, where blocking of funds will be done by respective SCSBs only). All applications shall be stamped and thereby acknowledged by the Designated Intermediaries at the time of receipt.
6. The Designated Intermediaries will enter each application option into the electronic collecting system as a separate application and generate a TRS and give the same to the applicant.
7. Upon receipt of the Application Form, submitted whether in physical or electronic mode, the Designated Intermediaries shall verify if sufficient funds equal to the Application Amount are available in the ASBA Account, as mentioned in the Application Form, prior to uploading such applications with the Stock Exchange.
8. If sufficient funds are not available in the ASBA Account, the Designated Intermediaries shall reject such applications and shall not upload such applications with the Stock Exchange.
9. If sufficient funds are available in the ASBA Account, the SCSB shall block an amount equivalent to the Application Amount mentioned in the Application Form and will enter each application option into the electronic collecting system as a separate application and generate a TRS for each price and demand option. The TRS shall be furnished to the Applicant on request.
10. The Application Amount shall remain blocked in the aforesaid ASBA Account until finalization of the Basis of Allotment and consequent transfer of the Application Amount against the Allotted Equity Shares to the Public Issue Account, or until withdrawal/ failure of the Issue or until withdrawal/ rejection of the Application Form, as the case may be. Once the Basis of Allotment is finalized, the Registrar to the Issue shall send an appropriate request to the Controlling Branch of the SCSB for unblocking the relevant ASBA Accounts and for transferring the amount allocable to the successful Applicants to the Public Issue Account. In case of withdrawal/ failure of the Issue, the blocked amount shall be unblocked on receipt of such information from the Registrar to the Issue.

TERMS OF PAYMENT

The entire Issue price of ₹[●]/- per share is payable on application. In case of allotment of lesser number of Equity Shares than the number applied, the Registrar shall instruct the SCSBs to unblock the excess amount paid on Application to the Applicants.

SCSBs will transfer the amount as per the instruction of the Registrar to the Public Issue Account, the balance amount after transfer will be unblocked by the SCSBs.

The applicants should note that the arrangement with Bankers to the Issue or the Registrar is not prescribed by SEBI and has been established as an arrangement between our Company, Banker to the Issue and the Registrar to the Issue to facilitate collections from the Applicants.

PAYMENT MECHANISM

The applicants shall specify the bank account number in their Application Form and the SCSBs shall block an amount equivalent to the Application Amount in the bank account specified in the Application Form. The SCSB shall keep the Application Amount in the relevant bank account blocked until withdrawal/rejection of the Application or receipt of instructions from the Registrar to unblock the Application Amount.

However, Non-Retail Applicants shall neither withdraw nor lower the size of their applications at any stage.

In the event of withdrawal or rejection of the Application Form or for unsuccessful Application Forms, the Registrar to the Issue shall give instructions to the SCSBs to unblock the application money in the relevant bank account within one day of receipt of such instruction. The Application Amount shall remain blocked in the ASBA Account until finalization of the Basis of Allotment in the Issue and consequent transfer of the Application Amount to the Public Issue Account, or until withdrawal/failure of the Issue or until rejection of the Application by the ASBA Applicant, as the case may be.

Please note that, in terms of SEBI Circular No. CIR/CFD/POLICYCELL/11/2015 dated November 10, 2015 and the SEBI (Issue of Capital and Disclosure Requirements) Regulations, 2018, all the investors applying in a public Offer shall use only Application Supported by Blocked Amount (ASBA) process for application providing details of the bank account which will be blocked by the Self-Certified Syndicate Banks (SCSBs) for the same. Further, pursuant to SEBI Circular No. SEBI/HO/CFD/DIL2/CIR/P/2018/138 dated November 01, 2018, Retail Individual Investors applying in public offer have to use UPI as a payment mechanism with Application Supported by Blocked Amount for making application.

ELECTRONIC REGISTRATION OF APPLICATIONS

1. The Designated Intermediaries will register the applications using the on-line facilities of the Stock Exchange.
2. The Designated Intermediaries will undertake modification of selected fields in the application details already uploaded before 1.00 p.m. of next Working Day from the Issue Closing Date.
3. The Designated Intermediaries shall be responsible for any acts, mistakes or errors or omissions and commissions in relation to, (i) the applications accepted by them, (ii) the applications uploaded by them (iii) the applications accepted but not uploaded by them or (iv) with respect to applications by Applicants, applications accepted and uploaded by any Designated Intermediary other than SCSBs, the Application form along with relevant schedules shall be sent to the SCSBs or the Designated Branch of the relevant SCSBs for blocking of funds and they will be responsible for blocking the necessary amounts in the ASBA Accounts. In case of Application accepted and uploaded by SCSBs, the SCSBs or the Designated Branch of the relevant SCSBs will be responsible for blocking the necessary amounts in the ASBA Accounts.
4. Neither the Lead Manager nor our Company nor the Registrar to the Issue, shall be responsible for any acts, mistakes or errors or omission and commissions in relation to, (i) The applications accepted by any Designated Intermediaries (ii) The applications uploaded by any Designated Intermediaries or (iii) The applications accepted but not uploaded by any Designated Intermediaries.
5. The Stock Exchange will offer an electronic facility for registering applications for the Issue. This facility will be available at the terminals of Designated Intermediaries and their authorized agents during the Issue Period. The Designated Branches or agents of Designated Intermediaries can also set up facilities for off-line

electronic registration of applications subject to the condition that they will subsequently upload the off-line data file into the online facilities on a regular basis. On the Issue Closing Date, the Designated Intermediaries shall upload the applications till such time as may be permitted by the Stock Exchange. This information will be available with the Lead Manager on a regular basis.

6. With respect to applications by Applicants, at the time of registering such applications, the Syndicate Bakers, DPs and RTAs shall forward a Schedule as per format given below along with the Application Forms to Designated Branches of the SCSBs for blocking of funds:

Sl. No.	Details*
1	Symbol
2	Intermediary Code
3	Location Code
4	Application No.
5	Category
6	PAN
7	DP ID
8	Client ID
9	Quantity
10	Amount

*Stock Exchanges shall uniformly prescribe character length for each of the above-mentioned fields

7. With respect to applications by Applicants, at the time of registering such applications, the Designated Intermediaries shall enter the following information pertaining to the Applicants into in the on-line system:
- ❖ Name of the Applicant;
 - ❖ FPO Name;
 - ❖ Application Form Number;
 - ❖ Investor Category;
 - ❖ PAN (of First Applicant, if more than one Applicant);
 - ❖ DP ID of the demat account of the Applicant;
 - ❖ Client Identification Number of the demat account of the Applicant;
 - ❖ Number of Equity Shares Applied for;
 - ❖ Bank Account details;
 - ❖ Locations of the Banker to the Issue or Designated Branch, as applicable, and bank code of the SCSB branch where the ASBA Account is maintained; and
 - ❖ Bank account number.
8. In case of submission of the Application by an Applicant through the Electronic Mode, the Applicant shall complete the above-mentioned details and mention the bank account number, except the Electronic ASBA Application Form number which shall be system generated.
9. The aforesaid Designated Intermediaries shall, at the time of receipt of application, give an acknowledgment to the investor, by giving the counter foil or specifying the application number to the investor, as a proof of having accepted the application form in physical as well as electronic mode. The registration of the Application by the Designated Intermediaries does not guarantee that the Equity Shares shall be allocated / allotted either by our Company.
10. Such acknowledgment will be non-negotiable and by itself will not create any obligation of any kind.
11. In case of Non-Retail Applicants and Retail Individual Applicants, applications would not be rejected except on the technical grounds as mentioned in the Draft Prospectus. The Designated Intermediaries shall have no right to reject applications, except on technical grounds.
12. The permission given by the Stock Exchanges to use their network and software of the Online FPO system should not in any way be deemed or construed to mean that the compliance with various statutory and other requirements by our Company and/or the Lead Manager are cleared or approved by the Stock Exchanges; nor does it in any manner warrant, certify or endorse the correctness or completeness of any of the compliance with the statutory and other requirements nor does it take any responsibility for the financial or other soundness of our company; our Promoter, our management or any scheme or project of our Company; nor does it in any manner warrant, certify or endorse the correctness or completeness of any of the contents of this Draft Prospectus, nor does it warrant that the Equity Shares will be listed or will continue to be listed on the Stock Exchanges.
13. The Designated Intermediaries will be given time till 1.00 p.m. on the next working day after the Issue Closing Date to verify the DP ID and Client ID uploaded in the online FPO system during the Issue

Period, after which the Registrar to the Issue will receive this data from the Stock Exchange and will validate the electronic application details with Depository's records. In case no corresponding record is available with Depositories, which matches the three parameters, namely DP ID, Client ID and PAN, then such applications are liable to be rejected.

14. The SCSBs shall be given one day after the Issue Closing Date to send confirmation of Funds blocked (Final certificate) to the Registrar to the Issue.
15. The details uploaded in the online FPO system shall be considered as final and Allotment will be based on such details for applications.

ALLOCATION OF EQUITY SHARES

- 1) The Issue is being made through the Fixed Price Process wherein [●] Equity Shares shall be reserved for Market Maker and [●] Equity shares (Net Issue) will be allocated on a proportionate basis to Retail Individual Applicants, and Non- Retail Applicants.
- 2) Under- subscription if any, in any category, would be allowed to be met with spill-over from any other category or combination of categories at the discretion of our Company in consultation with the Lead Managers and the Stock Exchange.
- 3) Allocation to Non-Residents, including Eligible NRIs, Eligible QFIs, FIIs and FVCIs registered with SEBI, applying on repatriation basis will be subject to applicable law, rules, regulations, guidelines and approvals.
- 4) In terms of SEBI Regulations, Non-Retail Applicants shall not be allowed to either withdraw or lower the size of their applications at any stage.
- 5) Allotment status details shall be available on the website of the Registrar to the Issue.

PRE-ISSUE ADVERTISEMENT

Subject to Section 30 of the Companies Act 2013 and 264(2) of the SEBI (ICDR) Regulations, 2018, our Company shall, after filing the prospectus with the RoC, publish a pre- Issue advertisement, in the form prescribed by the SEBI Regulations, in (i) English National Newspaper; (ii) Hindi National Newspaper and (iii) Regional Newspaper each with wide circulation where the registered office of the Company is situated.

ISSUANCE OF ALLOTMENT ADVICE (CAN)

- 1) Upon approval of the basis of allotment by the Designated Stock Exchange, the Lead Manager or Registrar to the Issue shall send to the SCSBs a list of their Applicants who have been allocated Equity Shares in the Issue.
- 2) On the basis of approved Basis of Allotment, the Issuer shall pass necessary corporate action to facilitate the allotment and credit of equity shares. Applicants are advised to instruct their Depository Participants to accept the Equity Shares that may be allotted to them pursuant to the issue. The Lead Manager or the Registrar to the Issue will dispatch an CAN to their Applicants who have been allocated Equity Shares in the Issue. The dispatch of a CAN shall be deemed a valid, binding and irrevocable contract for the Applicant.
- 3) Issuer will make the allotment of the Equity Shares and initiate corporate action for credit of shares to the successful applicants Depository Account within 4 working days of the Issue Closing date. The Issuer also ensures the credit of shares to the successful Applicants Depository Account is completed within one working Day from the date of allotment, after the funds are transferred from ASBA Public Issue Account to Public Issue account of the issuer.
The dispatch of Allotment Advice shall be deemed a valid, binding and irrevocable contract for the Allotment to such Applicant.

DESIGNATED DATES

Issue Opening Date	[●]
Issue Closing Date	[●]
Finalisation of Basis of Allotment with BSE SME	[●]
Initiation of Allotment / Refunds/ unblocking of ASBA Accounts	[●]
Credit of Equity Shares to demat accounts of the Allottees	[●]
Commencement of trading of the Equity Shares on BSE SME	[●]

Note: The above timetable is indicative in nature and does not constitute any obligation on the Company or the Lead Manager. While our Company shall ensure that all the steps for completion of all the necessary

formalities for the listing and trading of our equity shares on the SME Platform of BSE are taken within 6 working days of the issue closing date, the time table may change due to various factors such as extension of the issue period by the Company or any delay in receiving final listing and trading approval from the BSE. The Commencement of the trading of Equity shares will be entirely at the discretion of the BSE SME in accordance with the applicable laws

GENERAL INSTRUCTIONS

Do's:

- Check if you are eligible to apply;
- Read all the instructions carefully and complete the applicable Application Form;
- Ensure that the details about the PAN, DP ID and Client ID are correct and the Applicants depository account is active, as Allotment of Equity Shares will be in the dematerialized form only;
- Applicant shall use only his / her own bank account or only his / her own bank account linked UPI ID to make an application
- Ensure that the Demographic Details are updated, true and correct in all respects;
- Ensure that the name(s) given in the Application Form is exactly the same as the name(s) in which the beneficiary account is held with the Depository Participant.
- Ensure that you have funds equal to the Application Amount in the ASBA account or UPI ID linked Bank Account maintained with the SCSB before submitting the Application Form under the ASBA process to the respective member of the Syndicate (in the Specified Locations), the SCSBs, the Registered Broker (at the Broker Centers), the RTA (at the Designated RTA Locations) or CDP (at the Designated CDP Locations);
- Instruct your respective Banks to not release the funds blocked in the ASBA Account/UPI ID linked Bank Account under the ASBA process;
- Ensure that the Applications are submitted at the Collection centres only on forms bearing the stamp of the Syndicate or Registered Broker or RTAs or DPs or SCSB (except in case of electronic forms). Ensure that your Application is submitted either to a member of the Syndicate (in the Specified Locations), a Designated Branch of the SCSB where the Applicant has a bank account or a UPI ID linked Bank Account, or to a Registered Broker at the Broker Centres or to RTAs or DPs at collection centres and not to our Company.
- Ensure that the Application Form is signed by the account holder in case the applicant is not the account holder.
- Ensure that you have mentioned the correct ASBA Account number in the Application Form and in case of Retail Individual Applicants applying through UPI Channel, ensure that you have mentioned the correct UPI ID.
- Submit revised Applications to the same member of the Syndicate, SCSB or Non-Syndicate Registered Broker, or RTAs or DPs as applicable, through whom the original Application was placed and obtain a revised TRS;
- Ensure that the Application Forms are delivered by the applicants within the time prescribed as per the Application Form and the prospectus;
- Ensure that you have requested for and receive a TRS;
- Ensure that you request for and receive a stamped acknowledgement of the Application Form for all your application options;
- All Investors submit their applications through the ASBA process only except as mentioned in *SEBI Circular No. SEBI/HO/CFD/DCR2/CIR/P/2019/133 dated November 08, 2019 & SEBI/HO/CFD/DIL2/CIR/P/2021/2480/1/M dated March 16, 2021*;
- Ensure that you receive an acknowledgement from the concerned Designated Intermediary, for the submission of your Bid cum Application Form; and
- The Application Form is liable to be rejected if the above instructions, as applicable, are not complied with.

Don'ts:

- Do not apply for lower than the minimum Application size;
- Do not apply for a price different from the price mentioned herein or in the Application Form;
- Do not apply on another Application Form after you have submitted an application to the SCSBs, Registered Brokers of Stock Exchange, RTA and DPs registered with SEBI;
- Do not pay the Application Price in cash, by money order or by postal order or by stock invest;
- Do not send Application Forms by post, instead submit the Designated Intermediary only;
- Do not submit the Application Forms to any non-SCSB bank or our Company;
- Do not apply on an Application Form that does not have the stamp of the relevant Designated Intermediary;

- Do not submit the application without ensuring that funds equivalent to the entire application Amount are blocked in the relevant ASBA Account;
- Do not apply for an Application Amount exceeding Rs. 2,00,000 (for applications by Retail Individual Applicants);
- Do not fill up the Application Form such that the Equity Shares applied for exceeds the Issue Size and/or investment limit or maximum number of Equity Shares that can be held under the applicable laws or regulations or maximum amount permissible under the applicable regulations;
- Do not submit the GIR number instead of the PAN as the application is liable to be rejected on this ground;
- Do not submit incorrect details of the DP ID, beneficiary account number and PAN or provide details for a beneficiary account which is suspended or for which details cannot be verified by the Registrar to the Issue;
- Do not submit applications on plain paper or incomplete or illegible Application Forms in a color prescribed for another category of Applicant; and
- Do not make Applications if you are not competent to contract under the Indian Contract Act, 1872, as amended.
- Do not make more than one application from one bank account.
- Do not use third party bank account or third-party UPI ID linked Bank Account for making the Application;

Instructions for Completing the Application Form

The Applications should be submitted on the prescribed Application Form and in BLOCK LETTERS in ENGLISH only in accordance with the instructions contained herein and in the Application Form. Applications not so made are liable to be rejected. Applications made using a third-party bank account or using third party UPI ID linked bank account are liable to be rejected. Application Forms should bear the stamp of the Designated Intermediaries. ASBA Application Forms, which do not bear the stamp of the Designated Intermediaries, will be rejected.

SEBI, vide Circular No. CIR/CFD/14/2012 dated October 04, 2012 has introduced an additional mechanism for investors to submit Application forms in public issues using the stock broker (broker) network of Stock Exchanges, who may not be syndicate members in an issue with effect from January 01, 2013. The list of Broker Centre is available on the websites of BSE i.e., www.bseindia.com and NSE i.e., www.nseindia.com. With a view to broad base the reach of Investors by substantial, enhancing the points for submission of applications, SEBI vide Circular No. CIR/CFD/POLICY CELL/11/2015 dated November 10, 2015 has permitted Registrar to the Issue and Share Transfer Agent and Depository Participants registered with SEBI to accept the Application forms in Public Issue with effect front January 01, 2016. The List of ETA and DPs centers for collecting the application shall be disclosed is available on the websites of BSE i.e., www.bseindia.com and NSE i.e., www.nseindia.com.

Applicant's Depository Account and Bank Details

Please note that, providing bank account details, PAN No's, Client ID and DP ID in the space provided in the application form is mandatory and applications that do not contain such details are liable to be rejected.

Applicants should note that on the basis of name of the Applicants, Depository Participant's name, Depository Participant Identification number and Beneficiary Account Number provided by them in the Application Form as entered into the Stock Exchange online system, the Registrar to the Issue will obtain front the Depository the demographic details including address, Applicants bank account details, MICR code and occupation (hereinafter referred to as 'Demographic Details'). These Demographic Details would be used for all correspondence with the Applicants including mailing of the Allotment Advice. The Demographic Details given by Applicants in the Application Form would not be used for any other purpose by the Registrar to the Issue.

By signing the Application Form, the Applicant would be deemed to have authorized the depositories to provide, upon request, to the Registrar to the Issue, the required Demographic Details as available on its records.

Submission of Application Form

All Application Forms duly completed shall be submitted to the Designated Intermediaries. The aforesaid intermediaries shall, at the time of receipt of application, give an acknowledgement to investor, by giving the

counter foil or specifying the application number to the investor, as a proof of having accepted the application form, in physical or electronic mode, respectively.

Communications

All future communications in connection with Applications made in this Issue should be addressed to the Registrar to the Issue quoting the full name of the sole or First Applicant, Application Form number, Applicants Depository Account Details, number of Equity Shares applied for, date of Application form, name and address of the Designated Intermediary where the Application was submitted thereof and a copy of the acknowledgement slip.

Investors can contact the Compliance Officer or the Registrar to the Issue in case of any pre-Issue or post-Issue related problems such as non-receipt of letters of allotment, credit of allotted shares in the respective beneficiary accounts, etc.

Disposal of Application and Application Moneys and Interest in Case of Delay

The Company shall ensure the dispatch of Allotment advice, and give benefit to the beneficiary account with Depository Participants and submit the documents pertaining to the Allotment to the Stock Exchange within 2 (two) working days of date of Allotment of Equity Shares.

The Company shall use best efforts to ensure that all steps for completion of the necessary formalities for listing and commencement of trading at BSE SME platform where the Equity Shares are proposed to be listed are taken within 6 (Six) working days from Issue Closing Date.

In accordance with the Companies Act, the requirements of the Stock Exchange and the SEBI Regulations, the Company further undertakes that:

- Allotment and Listing of Equity Shares shall be made within 6 (Six) days of the Issue Closing Date;
- Giving of Instructions for refund by unblocking of amount via ASBA not later than 4 (four) working days of the Issue Closing Date, would be ensured; and
- If such money is not repaid within prescribed time from the date our Company becomes liable to repay it, then our Company and every officer in default shall, on and from expiry of prescribed time, be liable to repay such application money, with interest as prescribed under SEBI (ICDR) Regulations, the Companies Act, 2013 and applicable law. Further, in accordance with Section 40 of the Companies Act, 2013, the Company and each officer in default may be punishable with fine and/or imprisonment in such a case.

Right to Reject Applications

In case of QIB Applicants, the Company in consultation with the LM may reject Applications provided that the reasons for rejecting the same shall be provided to such Applicant in writing. In case of Non-Institutional Applicants, Retail Individual Applicants who applied, the Company has a right to reject Applications based on technical grounds.

OTHER INSTRUCTIONS FOR THE APPLICANTS

Joint Applications

In the case of Joint Applications, the Applications should be made in the name of the Applicant whose name appears first in the Depository account. The name so entered should be the same as it appears in the Depository records. The signature of only such First Applicant would be required in the Application Form and such First Applicant would be deemed to have signed on behalf of the joint holders. All communications may be addressed to such Applicant and may be dispatched to his or her address as per the Demographic Details received from the Depositories.

Multiple Applications

An Applicant should submit only one Application Form. Submission of a second Application Form to either the same or to the Designated Intermediaries and duplicate copies of Application Forms bearing the same application number shall be treated as multiple applications and are liable to be rejected.

IMPERSONATION:

Attention of the application is specifically drawn to the provisions of the sub-section (1) of Section 38 of the companies Act, 2013 which is reproduced below:

"Any person who

- a) Makes or abets making of an application in a fictitious name to a company for acquiring, or subscribing for, its securities; or
- b) Makes or abets making of multiple applications to a company in different names or in different combinations of his name or surname for acquiring or subscribing for its securities; or
- c) Otherwise induces directly or indirectly a company to allot, or register any transfer of, securities to him, or to any other person in a fictitious name, shall be liable for action under Section 447.
- d) The liability prescribed under Section 447 of the Companies Act, 2013 includes imprisonment for a term which shall not be less than six months extending upto 10 years (provided that where the fraud involves public interest, such term shall not be less than three years) and fine of an amount not less than the amount involved in the fraud, extending upto three times of such amount."

INVESTOR GRIEVANCES

In case of any pre-Issue or post-Issue related problems regarding demat credit/refund orders/unblocking etc., the Investors can contact the Compliance Officer of our Company.

NOMINATION FACILITY TO APPLICANT

Nomination facility is available in accordance with the provisions of Section 72 of the Companies Act, 2013. In case of allotment of the Equity Shares in dematerialized form, there is no need to make a separate nomination as the nomination registered with the Depository may prevail. For changing nominations, the Applicants should inform their respective DP.

GROUND FOR TECHNICAL REJECTIONS

Applicants are advised to note that the Applications are liable to be rejected, inter-alia, on the following technical grounds:

- Amount paid does not tally with the amount payable for the Equity shares applied for;
- In case of partnership firms, Application for Equity Shares made in the name of the individual partners and no firm as such shall be entitled to apply.
- Application by persons not competent to contract under the Indian Contract Act, 1872, including minors, insane person.
- PAN not mentioned in the Application Form.
- GIR number furnished instead of PAN.
- Applications for lower number of Equity Shares than the minimum specified for that category of investors;
- Applications made using a third-party bank account or using third party UPI ID linked bank account;
- Applications at a price other than the Fixed Price of the Issue;
- Applications for number of Equity Shares which are not in multiples of [●];
- Category not ticked;
- Multiple Applications as defined in this prospectus as such, based on common PAN;
- In case of Applications under power of attorney or by limited companies, corporate, trust etc., relevant documents are not being submitted;
- Signature of sole Applicant is missing;
- Application Forms are not delivered by the Applicants within the time prescribed as per the Application Form, Issue Opening Date advertisement and prospectus as per the instructions in this prospectus and Application Forms;
- In case no corresponding record is available with the Depositories that matches the DP ID, the Client ID and the PAN;
- Applications for amounts greater than the maximum permissible amounts prescribed by the regulations;
- Applications by OCBs;
- Applications by US person other than in reliance on Regulation S or "qualified institutional buyers" as defined in Rule 144A under the Securities Act;
- Application not duly signed by the sole applicant;

- Application by any person outside India if not in compliance with applicable foreign and Indian Laws;
- Application that do not comply with the securities laws of their respective jurisdictions are liable to be rejected.
- Applications by persons prohibited from buying, selling or dealing in the shares directly or indirectly by SEBI or any other regulatory authority;
- Application by person not eligible to acquire equity shares of the company in terms of all applicable laws, rules, regulations, guidelines, and approvals. Application or revision thereof by QIB Applicants, Non-Institutional Applicants where the Application Amount is in excess of Rs. 2,00,000 received after 3.00 pm on the issue Closing date unless the extended time is permitted by BSE.
- Inadequate funds in the bank account to block the Application Amount specified in the Application Form/Application Form at the time of blocking such Application Amount in the bank account;
- Where no confirmation is received from SCSB for blocking of funds;
- Applications by Applicants, other Retail Individual Applicants, not submitted through ASBA process and Applications by Retail Individual Applicants not submitted through ASBA process or the UPI process;
- Failure of Retail Individual Applicants to validate the request of blocking of Application amount sent by the Sponsor Bank;
- Applications not uploaded on the terminals of the Stock Exchanges;
- Applications by SCSBs wherein a separate account in its own name held with any other SCSB is not mentioned as the ASBA Account in the Application Form;
- Details of ASBA Account not provided in the Application form;
- In case of Retail Individual Applicants applying through the UPI mechanism, details of UPI ID, not provided in the Application form; etc.

For details of instruction in relation to the Application Form, Applicants may refer to the relevant section of GID and UPI Circular.

APPLICANT SHOULD NOTE THAT IN CASE THE PAN, THE DP ID AND CLIENT ID MENTIONED IN THE APPLICATION FORM AND ENTERED INTO THE ELECTRONIC APPLICATION SYSTEM OF THE STOCK EXCHANGE BY THE BROKERS DO NOT MATCH WITH PAN, THE DP ID AND CLIENT ID AVAILABLE IN THE DEPOSITORY DATABASE, THE APPLICATION FORM IS LIABLE TO BE REJECTED.

Names of entities responsible for finalizing the basis of allotment in a fair and proper manner

The authorised employees of the Stock Exchange, along with the LM and the Registrar, shall ensure that the Basis of Allotment is finalized in a fair and proper manner in accordance with the procedure specified in SEBI ICDR Regulations.

Completion of Formalities for Listing & Commencement of Trading

Our Company shall ensure that all steps for the completion of the necessary formalities for listing and commencement of trading at all the Stock Exchanges are taken within 6 (six) Working Days of the Issue Closing Date. The Registrar to the Issue may dispatch the Allotment Advice within 6 (six) Working Days of the Issue Closing Date.

SIGNING OF UNDERWRITING AGREEMENT AND FILING OF PROSPECTUS WITH ROC

- a) The issue is 100% underwritten. Our company has entered into an Underwriting Agreement dated [●] with Lead Manager. For Further information, please refer section “General Information” beginning from page no 46 of this prospectus.
- b) A copy of prospectus will be filed with the RoC in terms of Section 26 & 32 of Companies Act, 2013.

UNDERTAKINGS BY OUR COMPANY

We undertake as follows:

- 1) That the complaints received in respect of the Issue shall be attended to by us expeditiously and satisfactorily;
- 2) That all steps will be taken for the completion of the necessary formalities for listing and commencement of trading at the Stock Exchange where the Equity Shares are proposed to be listed within 6 (six) Working days of Issue Closing Date.

- 3) That the funds required for making refunds/unblocking to unsuccessful applicants as per the mode(s) disclosed shall be made available to the registrar to the issue by the issuer.
- 4) That where refunds are made through electronic transfer of funds, a suitable communication shall be sent to the applicant within the specified period of closure of the issue giving details of the bank where refunds shall be credited along with amount and expected date of electronic credit of refund.
- 5) That the promoters' contribution in full, wherever required, shall be brought in advance before the Issue opens for public subscription and the balance, if any, shall be brought on a pro rata basis before the calls are made on public in accordance with applicable provisions in these regulations.
- 6) That no further issue of securities shall be made till the securities offered through the prospectus are listed or till the application monies are refunded on account of non-listing, under subscription, etc., other than as disclosed in accordance with Regulation 19.
- 7) That adequate arrangements shall be made to collect all Applications Supported by Blocked Amount and to consider them similar to non-ASBA applications while finalizing the basis of allotment.
- 8) That if the Company do not proceed with the Issue, the reason thereof shall be given as a public notice to be issued by our Company within two days of the Issue Closing Date. The public notice shall be issued in the same newspapers where the pre- Issue advertisements were published. The stock exchange on which the Equity Shares are proposed to be listed shall also be informed promptly;
- 9) That if the Company withdraws the Issue after the Issue Closing Date, our Company shall be required to file a fresh offer document with the RoC/ SEBI, in the event our Company subsequently decides to proceed with the Issuer;

UTILIZATION OF ISSUE PROCEEDS

The Board of Directors of our Company certifies that:

- 1) All monies received out of the Issue shall be credited/ transferred to a separate bank account other than the bank account referred to in sub section (3) of Section 40 of the Companies Act 2013;
- 2) Details of all monies utilized out of the Issue referred above shall be disclosed and continue to be disclosed till the time any part of the issue proceeds remains unutilized, under an appropriate head in our balance sheet of our company indicating the purpose for which such monies have been utilized;
- 3) Details of all unutilized monies out of the Issue, if any shall be disclosed under the appropriate separate head in the balance sheet of our company indicating the form in which such unutilized monies have been invested.
- 4) The utilisation of monies received under the Promoters' contribution shall be disclosed, and continue to be disclosed till the time any part of the Issue Proceeds remains unutilised, under an appropriate head in the balance sheet of our Company indicating the purpose for which such monies have been utilised;
- 5) The details of all unutilised monies out of the funds received under the Promoters' contribution shall be disclosed under a separate head in the balance sheet of our Company indicating the form in which such unutilised monies have been invested.

EQUITY SHARES IN DEMATERIALIZED FORM WITH NSDL OR CDSL

To enable all shareholders of our Company to have their shareholding in electronic form, the Company had signed the following tripartite agreements with the Depositories and the Registrar and Share Transfer Agent:

- Tripartite Agreement dated October 13, 2022 between NSDL, our Company and Registrar to the Issue; and
- Tripartite Agreement dated October 12, 2022 between CDSL, our Company and Registrar to the Issue.

The Company's Equity Shares bear an ISIN No. INE0NJ001013.

RESTRICTIONS ON FOREIGN OWNERSHIP OF INDIAN SECURITIES

Foreign investment in Indian securities is regulated through the Industrial Policy, 1991 of the Government of India and Foreign Exchange Management Act, 1999 ("**FEMA**"). While the Industrial Policy, 1991 prescribes the limits and the conditions subject to which foreign investment can be made in different sectors of the Indian economy, FEMA regulates the precise manner in which such investment may be made. Under the Industrial Policy, unless specifically restricted, foreign investment is freely permitted in all sectors of Indian economy up to any extent and without any prior approvals, but the foreign investor is required to follow certain prescribed procedures for making such investment. The government bodies responsible for granting foreign investment approvals are the Reserve Bank of India ("**RBI**") and Department of Industrial Policy and Promotion, Ministry of Commerce and Industry, Government of India ("**DIPP**").

The Government of India has from time to time made policy pronouncements on FDI through press notes and press releases. The DPIIT issued the Consolidated Foreign Direct Investment Policy notified by the DPIIT File No. 5(2)/2020-FDI Policy dated October 15, 2020, with effect from October 15, 2020 (**the "FDI Policy"**), which consolidates and supersedes all previous press notes, press releases and clarifications on FDI issued by the DPIIT or the DPIIT that were in force and effect prior to October 15, 2020. The Government of India proposes to update the consolidated circular on FDI Policy once every year and therefore, the FDI Policy will be valid until the DPIIT issues an updated circular.

In terms of the FEMA NDI Rules, a person resident outside India may make investments into India, subject to certain terms and conditions, and provided that an entity of a country, which shares land border with India or the beneficial owner of an investment into India who is situated in or is a citizen of any such country, shall invest only with government approval

The transfer of shares between an Indian resident and a non-resident does not require the prior approval of the RBI, provided that (i) the activities of the investee company are under the automatic route under the foreign direct investment policy and transfer does not attract the provisions of the Takeover Regulations; (ii) the non resident shareholding is within the sectoral limits under the FDI policy; and (iii) the pricing is in accordance with the guidelines prescribed by the SEBI / RBI.

Further, in accordance with Press Note No. 3 (2020 Series), dated April 17, 2020 issued by the DPIIT and the Foreign Exchange Management (Non-debt Instruments) Amendment Rules, 2020 which came into effect from April 22, 2020, any investment, subscription, purchase or sale of equity instruments by entities of a country which shares land border with India or where the beneficial owner of an investment into India is situated in or is a citizen of any such country ("**Restricted Investors**"), will require prior approval of the Government, as prescribed in the Consolidated FDI Policy and the FEMA Rules. Further, in the event of transfer of ownership of any existing or future foreign direct investment in an entity in India, directly or indirectly, resulting in the beneficial ownership falling within the aforesaid restriction/purview, such subsequent change in the beneficial ownership will also require approval of the Government. Furthermore, on April 22, 2020, the Ministry of Finance, Government of India has also made a similar amendment to the FEMA Rules. Pursuant to the Foreign Exchange Management (Non-debt Instruments) (Fourth Amendment) Rules, 2020, a multilateral bank or fund, of which India is a member, shall not be treated as an entity of a particular country nor shall any country be treated as the beneficial owner of the investments of such bank of fund in India. Each Bidder should seek independent legal advice about its ability to participate in the Issue. In the event such prior approval of the Government of India is required, and such approval has been obtained, the Bidder shall intimate our Company and the Registrar to the Issue in writing about such approval along with a copy thereof within the Issue Period. As per the existing policy of the Government of India, OCBs cannot participate in this Issue and in accordance with the extant FDI guidelines on sectoral caps, pricing guidelines etc. as amended by Reserve bank of India, from time to time. Investors are advised to confirm their eligibility under the relevant laws before investing and/ or subsequent purchase or sale transaction in the Equity Shares of our Company. Investors will not offer, sell, pledge or transfer the Equity Shares of our Company to any person who is not eligible under applicable laws, rules, regulations, guidelines. Our Company, the Underwriters and their respective directors, officers, agents, affiliates and representatives, as applicable, accept no responsibility or liability for advising any investor on whether such investor is eligible to acquire Equity Shares of our Company.

INVESTMENT CONDITIONS/RESTRICTIONS FOR OVERSEAS ENTITIES

Under the current FDI Policy 2020, the maximum amount of Investment (sectoral cap) by foreign investor in an issuing entity is composite unless it is explicitly provided otherwise including all types of foreign investments, direct and indirect, regardless of whether it has been made for FDI, FPI, NRI/OCI, LLPs, FVCI, Investment Vehicles and DRs under Foreign Exchange Management (Non-debt Instruments) Rules, 2019. Any equity holding by a person resident

outside India resulting from conversion of any debt instrument under any arrangement shall be reckoned as foreign investment under the composite cap.

Portfolio Investment upto aggregate foreign investment level of 49% or sectoral/statutory cap, whichever is lower, will not be subject to either Government approval or compliance of sectoral conditions, if such investment does not result in transfer of ownership and/or control of Indian entities from resident Indian citizens to non-resident entities. Other foreign investments will be subject to conditions of Government approval and compliance of sectoral conditions as per FDI Policy. The total foreign investment, direct and indirect, in the issuing entity will not exceed the sectoral/statutory cap.

INVESTMENT BY FPI UNDER PORTFOLIO INVESTMENT SCHEME (PIS)

With regards to purchase/sale of capital instruments of an Indian company by an FPI under PIS the total holding by each FPI or an investor group as referred in SEBI (FPI) Regulations, 2014 shall not exceed 10% of the total paid-up equity capital on a fully diluted basis or less than 10% of the paid-up value of each series of debentures or preference shares or share warrants issued by an Indian company and the total holdings of all FPIs put together shall not exceed 24% of paid-up equity capital on fully diluted basis or paid-up value of each series of debentures or preference shares or share warrants. The said limit of 10% and 24% will be called the individual and aggregate limit, respectively. However, this limit of 24 % may be increased up to sectoral cap/statutory ceiling, as applicable, by the Indian company concerned by passing a resolution by its Board of Directors followed by passing of a special resolution to that effect by its general body.

INVESTMENT BY NRI OR OCI ON REPATRIATION BASIS:

The purchase/sale of equity shares, debentures, preference shares and share warrants issued by an Indian company (hereinafter referred to as "Capital Instruments") of a listed Indian company on a recognised stock exchange in India by Non-Resident Indian (NRI) or Overseas Citizen of India (OCI) on repatriation basis is allowed subject to certain conditions under Foreign Exchange Management (Non-debt Instruments) Rules, 2019. The total holding by any individual NRI or OCI shall not exceed 5% of the total paid-up equity capital on a fully diluted basis or should not exceed 5% of the paid-up value of each series of debentures or preference shares or share warrants issued by an Indian company and the total holdings of all NRIs and OCIs put together shall not exceed 10% of the total paid-up equity capital on a fully diluted basis or shall not exceed 10% of the paid-up value of each series of debentures or preference shares or share warrants; provided that the aggregate ceiling of 10% may be raised to 24% if a special resolution to that effect is passed by the general body of the Indian company.

INVESTMENT BY NRI OR OCI ON NON-REPATRIATION BASIS

As per current FDI Policy 2020, Foreign Exchange Management (Non-debt Instruments) Rules, 2019, Purchase/ sale of Capital Instruments or convertible notes or units or contribution to the capital of an LLP by a NRI or OCI on non-repatriation basis – will be deemed to be domestic investment at par with the investment made by residents. This is further subject to remittance channel restrictions.

The Equity Shares have not been and will not be registered under the U.S. Securities Act of 1933, as amended ("US Securities Act") or any other state securities laws in the United States of America and may not be sold or offered within the United States of America, or to, or for the account or benefit of "US Persons" as defined in Regulation S of the U.S. Securities Act, except pursuant to exemption from, or in a transaction not subject to, the registration requirements of US Securities Act and applicable state securities laws. Accordingly, the equity shares are being offered and sold only outside the United States of America in an offshore transaction in reliance upon Regulation S under the US Securities Act and the applicable laws of the jurisdiction where those offers and sale occur.

Further, no offer to the public (as defined under Directive 2003/71/EC, together with any amendments) and implementing measures thereto, (the "Prospectus Directive") has been or will be made in respect of the Issue in any member State of the European Economic Area which has implemented the Prospectus Directive except for any such offer made under exemptions available under the Prospectus Directive, provided that no such offer shall result in a requirement to publish or supplement a prospectus pursuant to the Prospectus Directive, in respect of the Issue.

Any forwarding, distribution or reproduction of this document in whole or in part may be unauthorised. Failure to comply with this directive may result in a violation of the Securities Act or the applicable laws of other jurisdictions. Any investment decision should be made on the basis of the final terms and conditions and the information contained in this Draft Prospectus.

The Equity Shares have not been and will not be registered, listed or otherwise qualified in any other jurisdiction outside India and may not be offered or sold, and Application may not be made by persons in any such jurisdiction, except in compliance with the applicable laws of such jurisdiction.

The above information is given for the benefit of the Applicants. Our Company and the Lead Manager are not liable for any amendments or modification or changes in applicable laws or regulations, which may occur after the date of this Draft Prospectus. Applicants are advised to make their independent investigations and ensure that the Applications are not in violation of laws or regulations applicable to them and do not exceed the applicable limits under the laws and regulations.

SECTION XI – MAIN PROVISIONS OF ARTICLES OF ASSOCIATION

Pursuant to the Companies Act and the SEBI ICDR Regulations, the main provisions of the Articles of Association are detailed below. Capitalised terms used in this section have the meaning given to them in the Articles of Association.

Each provision below is numbered as per the corresponding article number in the Articles of Association and defined terms herein have the meaning given to them in the Articles of Association.

Public Company

1. The company is a Public Company within the meaning of section 2(71) of the Companies Act, 2013.

Share capital and variation of rights

2. (i) The Authorized Share Capital of the Company shall be as laid down in Memorandum of Association of the Company.
 - (ii) Subject to the provisions of the Companies Act 2013 and the applicable Rules made there under, the Company / Board shall have power to issue / allot shares, whether on preferential basis or otherwise, from time to time and the shares shall be under the control of the Directors who may allot or otherwise dispose of the same to such persons, on such terms and conditions and at such times as the Directors think fit.
3. (i) Every person whose name is entered as a member in the register of members shall be entitled to receive within two months after incorporation, in case of subscribers to the memorandum or after allotment or within one month after the application for the registration of transfer or transmission or within such other period as the conditions of issue shall be provided:—
 - (a) One certificate for all his shares without payment of any charges; or
 - (b) Several certificates, each for one or more of his shares, upon payment of twenty rupees for each certificate after the first.
 - (ii) Every certificate shall be under the seal and shall specify the shares to which it relates and the amount paid-up thereon.
 - (iii) In respect of any share or shares held jointly by several persons, the company shall not be bound to issue more than one certificate, and delivery of a certificate for a share to one of several joint holders shall be sufficient delivery to all such holders.
4. (i) If any share certificate be worn out, defaced, mutilated or torn or if there be no further space on the back for endorsement of transfer, then upon production and surrender thereof to the company, a new certificate may be issued in lieu thereof, and if any certificate is lost or destroyed then upon proof thereof to the satisfaction of the company and on execution of such indemnity as the company deem adequate, a new certificate in lieu thereof shall be given. Every certificate under this Article shall be issued on payment of twenty rupees for each certificate.
 - (ii) The company may issue new share certificates pursuant to consolidation or sub-division of share certificate(s) upon written request received from shareholder together with production and surrender of respective original share certificate(s). Every certificate under this Article shall be issued on payment of twenty rupees for each certificate.
 - (iii) The provisions of Articles (5) and (6) shall mutatis mutandis apply to debentures of the company.
5. Except as required by law, no person shall be recognized by the company as holding any share upon any trust, and the company shall not be bound by, or be compelled in any way to recognize (even when having notice thereof) any equitable, contingent, future or partial interest in any share, or any interest in any fractional part of a share, or (except only as by these regulations or by law otherwise provided) any other rights in respect of any share except an absolute right to the entirety thereof in the registered holder.

6. (i) The company may exercise the powers of paying commissions conferred by sub-section (6) of section 40, provided that the rate per cent. or the amount of the commission paid or agreed to be paid shall be disclosed in the manner required by that section and rules made there under.
 - (ii) The rate or amount of the commission shall not exceed the rate or amount prescribed in rules made under sub-section (6) of section 40.
 - (iii) The commission may be satisfied by the payment of cash or the allotment of fully or partly paid shares or partly in the one way and partly in the other.
7. (i) If at any time the share capital is divided into different classes of shares, the rights attached to any class (unless otherwise provided by the terms of issue of the shares of that class) may, subject to the provisions of section 48 and whether or not the company is being wound up, be varied with the consent in writing of the holders of three-fourths of the issued shares of that class, or with the sanction of a special resolution passed at a separate meeting of the holders of the shares of that class.
 - (ii) To every such separate meeting, the provisions of these regulations relating to general meetings shall mutatis mutandis apply, but so that the necessary quorum shall be at least two persons holding at least one-third of the issued shares of the class in question.
8. The rights conferred upon the holders of the shares of any class issued with preferred or other rights shall not, unless otherwise expressly provided by the terms of issue of the shares of that class, be deemed to be varied by the creation or issue of further shares ranking *pari passu* therewith.
9. Subject to the provisions of section 55, any preference shares may, with the sanction of an ordinary resolution, be issued on the terms that they are to be redeemed on such terms and in such manner as the company before the issue of the shares may, by special resolution, determine.

Lien

10. (i) The company shall have a first and paramount lien—
 - (a) on every share (not being a fully paid share), for all monies (whether presently payable or not) called, or payable at a fixed time, in respect of that share; and
 - (b) on all shares (not being fully paid shares) standing registered in the name of a single person, for all monies presently payable by him or his estate to the company:

Provided that the Board of directors may at any time declare any share to be wholly or in part exempt from the provisions of this clause.

 - (ii) The company's lien, if any, on a share shall extend to all dividends payable and bonuses declared from time to time in respect of such shares.
 - (iii) The fully paid shares shall be free from all lien and that in the case of partly paid shares the Company's lien shall be restricted to monies called or payable at a fixed time in respect of such shares.
11. The company may sell, in such manner as the Board thinks fit, any shares on which the company has a lien: Provided that no sale shall be made—
 - (a) unless a sum in respect of which the lien exists is presently payable; or
 - (b) until the expiration of fourteen days after a notice in writing stating and demanding payment of such part of the amount in respect of which the lien exists as is presently payable, has been given to the registered holder for the time being of the share or the person entitled thereto by reason of his death or insolvency.
12. (i) To give effect to any such sale, the Board may authorise some person to transfer the shares sold to the purchaser thereof.
 - (ii) The purchaser shall be registered as the holder of the shares comprised in any such transfer.

(iii) The purchaser shall not be bound to see to the application of the purchase money, nor shall his title to the shares be affected by any irregularity or invalidity in the proceedings in reference to the sale.

13. (i) The proceeds of the sale shall be received by the company and applied in payment of such part of the amount in respect of which the lien exists as is presently payable.

(ii) The residue, if any, shall, subject to a like lien for sums not presently payable as existed upon the shares before the sale, be paid to the person entitled to the shares at the date of the sale.

Calls on shares

14. (i) The Board may, from time to time, make calls upon the members in respect of any monies unpaid on their shares (whether on account of the nominal value of the shares or by way of premium) and not by the conditions of allotment thereof made payable at fixed times:

Provided that no call shall exceed one-fourth of the nominal value of the share or be payable at less than one month from the date fixed for the payment of the last preceding call.

(ii) Each member shall, subject to receiving at least fourteen days' notice specifying the time or times and place of payment, pay to the company, at the time or times and place so specified, the amount called on his shares.

(iii) A call may be revoked or postponed at the discretion of the Board.

(iv) The option or right to make call on shares shall not be given to any person except with the sanction of the Company in General Meetings. That is, it may delegate power to make calls on shares subject to approval of the shareholder in a general meeting of the company.

15. A call shall be deemed to have been made at the time when the resolution of the Board authorizing the call was passed and may be required to be paid by instalments.

16. The joint holders of a share shall be jointly and severally liable to pay all calls in respect thereof.

17. (i) If a sum called in respect of a share is not paid before or on the day appointed for payment thereof, the person from whom the sum is due shall pay interest thereon from the day appointed for payment thereof to the time of actual payment at ten per cent. per annum or at such lower rate, if any, as the Board may determine.

(ii) The Board shall be at liberty to waive payment of any such interest wholly or in part.

18. (i) Any sum which by the terms of issue of a share becomes payable on allotment or at any fixed date, whether on account of the nominal value of the share or by way of premium, shall, for the purposes of these regulations, be deemed to be a call duly made and payable on the date on which by the terms of issue such sum becomes payable.

(ii) In case of non-payment of such sum, all the relevant provisions of these regulations as to payment of interest and expenses, forfeiture or otherwise shall apply as if such sum had become payable by virtue of a call duly made and notified.

19. The Board—

(a) may, if it thinks fit, receive from any member willing to advance the same, all or any part of the monies uncalled and unpaid upon any shares held by him; and

(b) upon all or any of the monies so advanced, may (until the same would, but for such advance, become presently payable) pay interest at such rate not exceeding, unless the company in general meeting shall otherwise direct, twelve per cent. per annum, as may be agreed upon between the Board and the member paying the sum in advance but shall not confer a right to dividend or to participate in profits.

Transfer of shares

20. (i) The Company shall use a Common form of transfer. The instrument of transfer of any share in the company shall be executed by or on behalf of both the transferor and transferee.
- (ii) The transferor shall be deemed to remain a holder of the share until the name of the transferee is entered in the register of members in respect thereof.
21. The Board may, subject to the right of appeal conferred by section 58 decline to register—
- (a) the transfer of a share, not being a fully paid share, to a person of whom they do not approve; or
- (b) any transfer of shares on which the company has a lien.
22. The Board may decline to recognise any instrument of transfer unless—
- (a) the instrument of transfer is in the form as prescribed in rules made under sub-section (1) of section 56;
- (b) the instrument of transfer is accompanied by the certificate of the shares to which it relates, and such other evidence as the Board may reasonably require to show the right of the transferor to make the transfer; and
- (c) the instrument of transfer is in respect of only one class of shares.
23. On giving not less than seven days' previous notice in accordance with section 91 and rules made there under, the registration of transfers may be suspended at such times and for such periods as the Board may from time to time determine:

Provided that such registration shall not be suspended for more than thirty days at any one time or for more than forty-five days in the aggregate in any year.

24. Subject to the provisions of Section 59 of Companies Act, 2013, the Board may decline to register any transfer of Shares on such grounds as it think fit in the benefit of the company (notwithstanding that the proposed transferee be already a Member), but in such case it shall, within two (2) months from the date the instrument of transfer was lodged with the Company, send to the transferee and the transferor notice of the refusal to register such transfer giving reasons for such refusal. Provided that registration of a transfer shall not be refused on the ground of the transferor being either alone or jointly with any other person or persons indebted to the Company on any account whatsoever.

Transmission of Shares

25. (i) On the death of a member, the survivor or survivors where the member was a joint holder, and his nominee or nominees or legal representatives where he was a sole holder, shall be the only persons recognised by the company as having any title to his interest in the shares.
- (ii) Nothing in clause (i) shall release the estate of a deceased joint holder from any liability in respect of any share which had been jointly held by him with other persons.
26. (i) Any person becoming entitled to a share in consequence of the death or insolvency of a member may, upon such evidence being produced as may from time to time properly be required by the Board and subject as hereinafter provided, elect, either—
- (a) to be registered himself as holder of the share; or
- (b) to make such transfer of the share as the deceased or insolvent member could have made.
- (ii) The Board shall, in either case, have the same right to decline or suspend registration as it would have had, if the deceased or insolvent member had transferred the share before his death or insolvency.

27. (i) If the person so becoming entitled shall elect to be registered as holder of the share himself, he shall deliver or send to the company a notice in writing signed by him stating that he so elects.
- (ii) If the person aforesaid shall elect to transfer the share, he shall testify his election by executing a transfer of the share.
- (iii) All the limitations, restrictions and provisions of these regulations relating to the right to transfer and the registration of transfers of shares shall be applicable to any such notice or transfer as aforesaid as if the death or insolvency of the member had not occurred and the notice or transfer were a transfer signed by that member.

28. A person becoming entitled to a share by reason of the death or insolvency of the holder shall be entitled to the same dividends and other advantages to which he would be entitled if he were the registered holder of the share, except that he shall not, before being registered as a member in respect of the share, be entitled in respect of it to exercise any right conferred by membership in relation to meetings of the company:

Provided that the Board may, at any time, give notice requiring any such person to elect either to be registered himself or to transfer the share, and if the notice is not complied with within ninety days, the Board may thereafter withhold payment of all dividends, bonuses or other monies payable in respect of the share, until the requirements of the notice have been complied with.

Forfeiture of Shares

29. If a member fails to pay any call, or installment of a call, on the day appointed for payment thereof, the Board may, at any time thereafter during such time as any part of the call or installment remains unpaid, serve a notice on him requiring payment of so much of the call or installment as is unpaid, together with any interest which may have accrued.
30. The notice aforesaid shall—
- (a) name a further day (not being earlier than the expiry of fourteen days from the date of service of the notice) on or before which the payment required by the notice is to be made; and
- (b) state that, in the event of non-payment on or before the day so named, the shares in respect of which the call was made shall be liable to be forfeited.
31. If the requirements of any such notice as aforesaid are not complied with, any share in respect of which the notice has been given may, at any time thereafter, before the payment required by the notice has been made, be forfeited by a resolution of the Board to that effect.
32. (i) A forfeited share may be sold or otherwise disposed of on such terms and in such manner as the Board thinks fit.
- (ii) At any time before a sale or disposal as aforesaid, the Board may cancel the forfeiture on such terms as it thinks fit.
33. (i) A person whose shares have been forfeited shall cease to be a member in respect of the forfeited shares, but shall, notwithstanding the forfeiture, remain liable to pay to the company all monies which, at the date of forfeiture, were presently payable by him to the company in respect of the shares.
- (ii) The liability of such person shall cease if and when the company shall have received payment in full of all such monies in respect of the shares.
34. (i) A duly verified declaration in writing that the declarant is a director, the manager or the secretary, of the company, and that a share in the company has been duly forfeited on a date stated in the declaration, shall be conclusive evidence of the facts therein stated as against all persons claiming to be entitled to the share.
- (ii) The company may receive the consideration, if any, given for the share on any sale or disposal thereof and may execute a transfer of the share in favour of the person to whom the share is sold or disposed of.

(iii) The transferee shall thereupon be registered as the holder of the share

(iv) The transferee shall not be bound to see to the application of the purchase money, if any, nor shall his title to the share be affected by any irregularity or invalidity in the proceedings in reference to the forfeiture, sale or disposal of the share.

35. The provisions of these regulations as to forfeiture shall apply in the case of nonpayment of any sum which, by the terms of issue of a share, becomes payable at a fixed time, whether on account of the nominal value of the share or by way of premium, as if the same had been payable by virtue of a call duly made and notified.

Alteration of Capital

36. The company may, from time to time, by ordinary resolution increase the share capital by such sum, to be divided into shares of such amount, as may be specified in the resolution. The Authorised Share Capital shall be as per the clause V (a) of Memorandum of Association of the company.

37. Subject to the provisions of section 61, the company may, by ordinary resolution,—

(a) increase its authorised share capital by such amount as it thinks expedient.

(b) consolidate and divide all or any of its share capital into shares of larger amount than its existing shares;

(c) convert all or any of its fully paid-up shares into stock, and reconvert that stock into fully paid-up shares of any denomination;

(d) sub-divide its existing shares or any of them into shares of smaller amount than is fixed by the memorandum;

(e) cancel any shares which, at the date of the passing of the resolution, have not been taken or agreed to be taken by any person.

38. Where shares are converted into stock,—

(a) the holders of stock may transfer the same or any part thereof in the same manner as, and subject to the same regulations under which, the shares from which the stock arose might before the conversion have been transferred, or as near thereto as circumstances admit:

Provided that the Board may, from time to time, fix the minimum amount of stock transferable, so, however, that such minimum shall not exceed the nominal amount of the shares from which the stock arose.

(b) the holders of stock shall, according to the amount of stock held by them, have the same rights, privileges and advantages as regards dividends, voting at meetings of the company, and other matters, as if they held the shares from which the stock arose; but no such privilege or advantage (except participation in the dividends and profits of the company and in the assets on winding up) shall be conferred by an amount of stock which would not, if existing in shares, have conferred that privilege or advantage.

(c) such of the regulations of the company as are applicable to paid-up shares shall apply to stock and the words “share” and “shareholder” in those regulations shall include “stock” and “stock-holder” respectively.

39. The company may, by special resolution, reduce in any manner and with, and subject to, any incident authorised and consent required by law,—

(a) its share capital;

(b) any capital redemption reserve account; or

(c) any share premium account.

Capitalisation of profits

40. (i) The company in general meeting may, upon the recommendation of the Board resolve—
- (a) that it is desirable to capitalise any part of the amount for the time being standing to the credit of any of the company's reserve accounts, or to the credit of the profit and loss account, Securities Premium Accounts or otherwise available for distribution; and
 - (b) that such sum be accordingly set free for distribution in the manner specified in clause (ii) amongst the members who would have been entitled thereto, if distributed by way of dividend and in the same proportions.
- (ii) The sum aforesaid shall not be paid in cash but shall be applied, subject to the provision contained in clause (iii), either in or towards—
- (a) paying up any amounts for the time being unpaid on any shares held by such members respectively;
 - (b) paying up in full, unissued shares of the company to be allotted and distributed, credited as fully paid-up, to and amongst such members in the proportions aforesaid;
 - (c) partly in the way specified in sub-clause (A) and partly in that specified in sub-clause (B);
- (iii) A securities premium account and a capital redemption reserve account may, for the purposes of this regulation, be applied in the paying up of unissued shares to be issued to members of the company as fully paid bonus shares;
- (iv) The Board shall give effect to the resolution passed by the company in pursuance of this regulation.
41. (i) Whenever such a resolution as aforesaid shall have been passed, the Board shall—
- (a) make all appropriations and applications of the undivided profits resolved to be capitalised thereby, and all allotments and issues of fully paid shares if any; and
 - (b) generally do all acts and things required to give effect thereto.
- (ii) The Board shall have power—
- (a) to make such provisions, by the issue of fractional certificates or by payment in cash or otherwise as it thinks fit, for the case of shares becoming distributable in fractions; and
 - (b) to authorise any person to enter, on behalf of all the members entitled thereto, into an agreement with the company providing for the allotment to them respectively, credited as fully paid-up, of any further shares to which they may be entitled upon such capitalisation, or as the case may require, for the payment by the company on their behalf, by the application thereto of their respective proportions of profits resolved to be capitalised, of the amount or any part of the amounts remaining unpaid on their existing shares;
- (iii) Any agreement made under such authority shall be effective and binding on such members.

Dematerialisation of Securities

42. For the purpose of this Article:-

"Beneficial Owner": Beneficial Owner shall have the meaning assigned thereto in section 2(1)(a) of the Depositories Act, 1996.

"Depositories Act": Depositories Act shall mean the Depositories Act, 1996 and includes any statutory modification or re-enactment thereof for the time being in force.

"Depository": Depository shall mean a Depository as defined in section 2(1)(e) of the Depositories Act, 1996.

"Member": Member shall mean a duly registered holder from time to time of the security of the company and includes every person whose name is entered as beneficial owner in the records of the Depository.

"Security": Security shall mean such security as may be specified by SEBI.

"Dematerialisation of Securities": Notwithstanding anything on the contrary contained in this Article, the company shall be entitled to dematerialise its securities and to offer securities in a dematerialised form and further to rematerialise the securities held on depository pursuant to the Depositories Act, 1996 or any amendment thereof.

"Option to hold securities in physical form or with depository": Every person holding securities of the company through allotment or otherwise shall have the option to receive and hold the same in the dematerialised form with a depository.

"Beneficial Owner may opt out of a Depository": Every person holding securities of the company with a depository, being the beneficial owner thereof, may at any time opt out of the depository in the manner provided under the provisions of the Depositories Act and the Rules, if any, prescribed there under and on fulfilment of the conditions prescribed by the company from time to time, company shall issue the relevant security certificates to the beneficial owner thereof.

"Securities in Depositories to be in fungible form": All securities held by a depository shall be dematerialised and shall be in fungible form. Nothing contained in Sections 153, 153A, 153B, 187B, 187C and 372A of the Companies Act, shall apply to a depository in respect of the securities held by it on behalf of the beneficial owners.

"Rights of depository and beneficial owners": A depository shall be deemed to be the registered owner for the purposes of affecting the transfer of ownership of securities on behalf of the beneficial owners and shall not have any voting rights or any other rights in respect of the securities held by it.

Every person holding securities of the Company and whose name is entered as the beneficial owner in the records of the depository shall be deemed to be a member of the Company. The beneficial owner of securities shall be entitled to all rights and benefits and be subject to all the liabilities in respect of his/her securities, which are held by a depository.

"Transfer of securities": Transfer of security held in a depository will be governed by the provisions of the Depository Act, 1996. Nothing contained in Section 56 of the Companies Act, 2013 or these Articles shall apply to a transfer of securities effected by a transferor and transferee both of whom are entered as beneficial owners in the records of a depository.

"Register and Index of beneficial owners": The Register and Index of beneficial owners maintained by a depository under the Depositories Act, 1996 shall be deemed to be the Register and Index of Members and Security holders for the purpose of these Articles.

"Other matters": Notwithstanding anything contained in these Articles, the provision of Depositories Act, 1996 relating to dematerialisation of securities including any modification(s) or re-enactment thereof and Rules/Regulations made there under shall prevail accordingly.

Notwithstanding anything contained in the Act or the Articles, where securities are held in a depository, the records of the beneficial ownership may be served by such depository on the company by means of electronic mode or by delivery of floppies or disks.

Nomination

43. Notwithstanding anything contained in Articles, every holder of shares(s) or debenture(s) of the Company may, at any time, nominate, in the prescribed manner, a person to whom these share(s) shall vest in the event of his death and the provisions of Section 109A and Section 109B of the Companies Act, 1956 shall apply in respect of such nomination.

The provisions of this Article shall apply mutatis mutandis to a depository of money with the Company as per the provisions of Section 58A of the Act.

Buy-Back of Shares

44. Notwithstanding anything contained in these articles but subject to the provisions of sections 68 to 70 and any other applicable provision of the Act or any other law for the time being in force, the company may purchase its own shares or other specified securities.

General Meetings

45. All general meetings other than Annual General Meeting shall be called extraordinary general meeting.
46. (i) The Board may, whenever it thinks fit, call an extraordinary general meeting.
- (ii) If at any time directors capable of acting who are sufficient in number to form a quorum are not within India, any director or any two members of the company may call an extraordinary general meeting in the same manner, as nearly as possible, as that in which such a meeting may be called by the Board.

Proceedings at General Meetings

47. (i) No business shall be transacted at any general meeting unless a quorum of members is present at the time when the meeting proceeds to business.
- (ii) Save as otherwise provided herein, the quorum for the general meetings shall be as provided in section 103.
- (iii) The chairperson, if any, of the Board shall preside as Chairperson at every general meeting of the company.
- (iv) If there is no such Chairperson, or if he is not present within fifteen minutes after the time appointed for holding the meeting, or is unwilling to act as chairperson of the meeting, the directors present shall elect one of their members to be Chairperson of the meeting.
- (v) If at any meeting no director is willing to act as Chairperson or if no director is present within fifteen minutes after the time appointed for holding the meeting, the members present shall choose one of their members to be Chairperson of the meeting.

Adjournment of Meeting

48. (i) The Chairperson may, with the consent of any meeting at which a quorum is present, and shall, if so directed by the meeting, adjourn the meeting from time to time and from place to place.
- (ii) No business shall be transacted at any adjourned meeting other than the business left unfinished at the meeting from which the adjournment took place.
- (iii) When a meeting is adjourned for thirty days or more, notice of the adjourned meeting shall be given as in the case of an original meeting.
- (iv) Save as aforesaid, and as provided in section 103 of the Act, it shall not be necessary to give any notice of an adjournment or of the business to be transacted at an adjourned meeting.

Voting Rights

49. Subject to any rights or restrictions for the time being attached to any class or classes of shares,—
- (a) on a show of hands, every member present in person shall have one vote; and
- (b) on a poll, the voting rights of members shall be in proportion to his share in the paid-up equity share capital of the company.

50. A member may exercise his vote at a meeting by electronic means in accordance with section 108 and shall vote only once.
51. (i) In the case of joint holders, the vote of the senior who tenders a vote, whether in person or by proxy, shall be accepted to the exclusion of the votes of the other joint holders.
- (ii) For this purpose, seniority shall be determined by the order in which the names stand in the register of members.
52. A member of unsound mind, or in respect of whom an order has been made by any court having jurisdiction in lunacy, may vote, whether on a show of hands or on a poll, by his committee or other legal guardian, and any such committee or guardian may, on a poll, vote by proxy.
53. Any business other than that upon which a poll has been demanded may be proceeded with, pending the taking of the poll.
54. No member shall be entitled to vote at any general meeting unless all calls or other sums presently payable by him in respect of shares in the company have been paid.
55. (i) No objection shall be raised to the qualification of any voter except at the meeting or adjourned meeting at which the vote objected to is given or tendered, and every vote not disallowed at such meeting shall be valid for all purposes.
- (ii) Any such objection made in due time shall be referred to the Chairperson of the meeting, whose decision shall be final and conclusive.

Proxy

56. The instrument appointing a proxy and the power-of-attorney or other authority, if any, under which it is signed or a notarised copy of that power or authority, shall be deposited at the registered office of the company not less than 48 hours before the time for holding the meeting or adjourned meeting at which the person named in the instrument proposes to vote, or, in the case of a poll, not less than 24 hours before the time appointed for the taking of the poll; and in default the instrument of proxy shall not be treated as valid.
57. An instrument appointing a proxy shall be in the form as prescribed in the rules made under section 105.
58. A vote given in accordance with the terms of an instrument of proxy shall be valid, notwithstanding the previous death or insanity of the principal or the revocation of the proxy or of the authority under which the proxy was executed, or the transfer of the shares in respect of which the proxy is given:
- Provided that no intimation in writing of such death, insanity, revocation or transfer shall have been received by the company at its office before the commencement of the meeting or adjourned meeting at which the proxy is used.

Board of Directors

59. The minimum number of Directors shall be 3 and maximum number of directors shall be 15.
The following shall be the First Directors of the Company:
1. Mr. Gautam Makker s/o Niranjan Dev Makker; and
 2. Mr. Sunil Menon s/o C.K. Menon
60. (i) Subject to the provisions of the Act, the Company may pay any remuneration, as determined by the Board of Directors / General Meeting to all or any of its Directors for the services rendered by them / him in day to day management of the affairs of the company or any other type of services, whether professional in nature or not, for any of the purposes of the company, either by a fixed sum on monthly or annual basis and / or perquisites and / or a percentage of the profits or otherwise as may be determined by the Board or the members in General Meeting.

The remuneration of the directors shall, in so far as it consists of a monthly payment, be deemed to accrue from day-to-day.

- (ii) In addition to the remuneration payable to them in pursuance of the Act, the directors may be paid all travelling, hotel and other expenses properly incurred by them—
- (a) in attending and returning from meetings of the Board of Directors or any committee thereof or general meetings of the company; or
- (b) in connection with the business of the company.
61. The Board may pay all expenses incurred in getting up and registering the company.
62. The company may exercise the powers conferred on it by section 88 with regard to the keeping of a foreign register; and the Board may (subject to the provisions of that section) make and vary such regulations as it may think fit respecting the keeping of any such register.
63. All cheques, promissory notes, drafts, hundis, bills of exchange and other negotiable instruments, and all receipts for monies paid to the company, shall be signed, drawn, accepted, endorsed, or otherwise executed, as the case may be, by such person and in such manner as the Board shall from time to time by resolution determine.
64. Every director present at any meeting of the Board or of a committee thereof shall sign his name in a book to be kept for that purpose.
65. (i) Subject to the provisions of section 149, the Board shall have power at any time, and from time to time, to appoint a person as an additional director, provided the number of the directors and additional directors together shall not at any time exceed the maximum strength fixed for the Board by the articles.
- (ii) Such person shall hold office only up to the date of the next annual general meeting of the company but shall be eligible for appointment by the company as a director at that meeting subject to the provisions of the Act.

Proceedings of the Board

66. (i) The Board of Directors may meet for the conduct of business, adjourn and otherwise regulate its meetings, as it thinks fit.
- (ii) Subject to the Articles herein, a director may, and the manager or secretary on the requisition of a director shall, at any time, summon a meeting of the Board.
- (iii) Save as otherwise expressly provided in the Act, questions arising at any meeting of the Board shall be decided by a majority of votes.
- (iv) In case of an equality of votes, the Chairperson of the Board, if any, shall have a second or casting vote.
67. The continuing directors may act notwithstanding any vacancy in the Board; but, if and so long as their number is reduced below the quorum fixed by the Act for a meeting of the Board, the continuing directors or director may act for the purpose of increasing the number of directors to that fixed for the quorum, or of summoning a general meeting of the company, but for no other purpose.
68. (i) The Board may elect a Chairperson of its meetings and determine the period for which he is to hold office.
- (ii) If no such Chairperson is elected, or if at any meeting the Chairperson is not present within five minutes after the time appointed for holding the meeting, the directors present may choose one of their number to be Chairperson of the meeting.
69. (i) The Board may, subject to the provisions of the Act, delegate any of its powers to committees consisting of such member or members of its body as it thinks fit.
- (ii) Any committee so formed shall, in the exercise of the powers so delegated, conform to any regulations that may be imposed on it by the Board.

70. A committee may elect a Chairperson of its meetings.
71. If no such Chairperson is elected, or if at any meeting the Chairperson is not present within five minutes after the time appointed for holding the meeting, the members present may choose one of their members to be Chairperson of the meeting.
72. (i) A committee may meet and adjourn as it thinks fit.
- (ii) Questions arising at any meeting of a committee shall be determined by a majority of votes of the members present, and in case of an equality of votes, the Chairperson shall have a second or casting vote.
73. All acts done in any meeting of the Board or of a committee thereof or by any person acting as a director, shall, notwithstanding that it may be afterwards discovered that there was some defect in the appointment of any one or more of such directors or of any person acting as aforesaid, or that they or any of them were disqualified, be as valid as if every such director or such person had been duly appointed and was qualified to be a director.
74. Save as otherwise expressly provided in the Act, a resolution in writing, signed by all the members of the Board or of a committee thereof, for the time being entitled to receive notice of a meeting of the Board or committee, shall be valid and effective as if it had been passed at a meeting of the Board or committee, duly convened and held.

Chief Executive Officer, Manager, Company Secretary or Chief Financial Officer

75. Subject to the provisions of the Act,—
- (i) A chief executive officer, manager, company secretary or chief financial officer may be appointed by the Board for such term, at such remuneration and upon such conditions as it may think fit; and any chief executive officer, manager, company secretary or chief financial officer so appointed may be removed by means of a resolution of the Board;
- (ii) A director may be appointed as chief executive officer, manager, company secretary or chief financial officer.
76. A provision of the Act or these regulations requiring or authorising a thing to be done by or to a director and chief executive officer, manager, company secretary or chief financial officer shall not be satisfied by its being done by or to the same person acting both as director and as, or in place of, chief executive officer, manager, company secretary or chief financial officer.

Managing Director

77. The business of the Company may be carried on by the Managing Director(s) who may be appointed by the Board of Directors / members in their General Meeting, from time to time who shall fix the terms, qualifications, remuneration, duties, authorities and powers. The Board may from time to time and subject to the provisions of the Act delegate to the Managing Director(s) such of their powers and duties and subject to such limitations and conditions as they may deem fit. The Board may from time to time, revoke, withdraw, alter or vary all or any of the powers conferred on him or dismiss him from office and appoint another in his place.
78. Subject to the provisions of section 179 and 180 of the Companies Act, 2013, the Managing Director of the Company, if any, shall be empowered to carry on the day to day business affairs of the Company. He shall have the general control, management and superintendence of the business of the Company with power to appoint and to dismiss employees and to enter into contracts on behalf of the Company in the ordinary course of business and to do and perform all other acts, deeds and things which in the ordinary course of business may be considered necessary/proper or in the interest of the Company.

The Seal

79. (i) The Board shall provide for the safe custody of the seal.
- (ii) The seal of the company shall not be affixed to any instrument except by the authority of a resolution of the Board or of a committee of the Board authorised by it in that behalf, and except in the presence of at least

two directors and of the secretary or such other person as the Board may appoint for the purpose; and those two directors and the secretary or other person aforesaid shall sign every instrument to which the seal of the company is so affixed in their presence.

Dividends and Reserve

80. The company in general meeting may declare dividends, but no dividend shall exceed the amount recommended by the Board.
81. Subject to the provisions of section 123, the Board may from time to time pay to the members such interim dividends as appear to it to be justified by the profits of the company.
82. (i) The Board may, before recommending any dividend, set aside out of the profits of the company such sums as it thinks fit as a reserve or reserves which shall, at the discretion of the Board, be applicable for any purpose to which the profits of the company may be properly applied, including provision for meeting contingencies or for equalizing dividends; and pending such application, may, at the like discretion, either be employed in the business of the company or be invested in such investments (other than shares of the company) as the Board may, from time to time, think fit.
- (ii) The Board may also carry forward any profits which it may consider necessary not to divide, without setting them aside as a reserve.
83. (i) Subject to the rights of persons, if any, entitled to shares with special rights as to dividends, all dividends shall be declared and paid according to the amounts paid or credited as paid on the shares in respect whereof the dividend is paid, but if and so long as nothing is paid upon any of the shares in the company, dividends may be declared and paid according to the amounts of the shares.
- (ii) No amount paid or credited as paid on a share in advance of calls shall be treated for the purposes of this regulation as paid on the share.
- (iii) All dividends shall be apportioned and paid proportionately to the amounts paid or credited as paid on the shares during any portion or portions of the period in respect of which the dividend is paid; but if any share is issued on terms providing that it shall rank for dividend as from a particular date such share shall rank for dividend accordingly.
84. The Board may deduct from any dividend payable to any member all sums of money, if any, presently payable by him to the company on account of calls or otherwise in relation to the shares of the company.
85. (i) Any dividend, interest or other monies payable in cash in respect of shares may be paid by cheque or warrant sent through the post directed to the registered address of the holder or, in the case of joint holders, to the registered address of that one of the joint holders who is first named on the register of members, or to such person and to such address as the holder or joint holders may in writing direct.
- (ii) Every such cheque or warrant shall be made payable to the order of the person to whom it is sent
86. Any one of two or more joint holders of a share may give effective receipts for any dividends, bonuses or other monies payable in respect of such share.
87. Notice of any dividend that may have been declared shall be given to the persons entitled to share therein in the manner mentioned in the Act.
88. No dividend shall bear interest against the company.
89. No unclaimed Dividend shall be forfeited before the claim becomes barred by law, and unclaimed Dividends shall be dealt with in accordance with the applicable provisions of the Act

Accounts

90. (i) The Board shall from time to time determine whether and to what extent and at what times and places and under what conditions or regulations, the accounts and books of the company, or any of them, shall be open to the inspection of members not being directors.
- (ii) No member (not being a director) shall have any right of inspecting any account or book or document of the company except as conferred by law or authorised by the Board or by the company in general meeting.

Winding Up

91. If the company shall be wound up, the liquidator may, with the sanction of a special resolution of the company and any other sanction required by the Act, divide amongst the members, in specie or kind, the whole or any part of the assets of the company, whether they shall consist of property of the same kind or not.
92. For the purpose aforesaid, the liquidator may set such value as he deems fair upon any property to be divided as aforesaid and may determine how such division shall be carried out as between the members or different classes of members.
93. The liquidator may, with the like sanction, vest the whole or any part of such assets in trustees upon such trusts for the benefit of the contributories if he considers necessary, but so that no member shall be compelled to accept any shares or other securities whereon there is any liability.

Indemnity

Every officer of the company shall be indemnified out of the assets of the company against any liability incurred by him in defending any proceedings, whether civil or criminal, in which judgment is given in his favour or in which he is acquitted or in which relief is granted to him by the court or the Tribunal.

SECTION XII – OTHER INFORMATION

MATERIAL CONTRACTS AND DOCUMENTS FOR INSPECTION

The following contracts (not being contracts entered into in the ordinary course of business carried on by our Company or contracts entered into more than two (2) years before the date of filing of this Draft Prospectus which are or may be deemed material have been entered or are to be entered into by our Company. These contracts, copies of which will be attached to the copy of the Prospectus, will be delivered to the ROC for registration/submission of the Prospectus and also the documents for inspection referred to hereunder, may be inspected at the Registered Office of our Company and on our website at www.cffdefensys.com, from date of filing of Prospectus with ROC on all Working Days until the Issue Closing Date.

1. Material Contracts for the Issue

- a. Issue Agreement dated November 05, 2024 entered into between our Company and the Lead Manager .
- b. Registrar Agreement dated November 05, 2024 entered into amongst our Company and the Registrar to the Issue.
- c. Tripartite Agreement dated October, 13 2022 between our Company, NSDL and the Registrar to the Issue.
- d. Tripartite Agreement dated October, 12 2022 between our Company, CDSL and the Registrar to the Issue.
- e. Market Making Agreement dated [●] between our Company, Lead Manager and Market Maker.
- f. Underwriting Agreement dated [●] amongst our Company, Lead Manager and the Underwriters.

2. Material Documents for the Issue

- a. Certified copies of the updated Memorandum and Articles of Association of our Company as amended until date;
- b. Copy of Certificate of Incorporation dated February 16, 2012 issued under the name Flash Forge Fluid Control Private Limited by Registrar of Companies, Maharashtra, Mumbai
- c. Copy of Fresh Certificate of Incorporation Consequent upon Change of Name dated October 19, 2012 issued by Registrar of Companies, Maharashtra, Mumbai consequent to name change from Flash Forge Fluid Control Private Limited to CFF Fluid Control Private Limited.
- d. Copy of Certificate of Incorporation Consequent upon conversion to Public Limited Company dated September 15, 2022 issued by Registrar of Companies, Mumbai consequent upon conversion from CFF Fluid Control Private Limited to CFF Fluid Control Limited.
- e. Copy of Resolution of the Board of Directors of our Company, dated September 05, 2024 in relation to approving the Offer and other related matters;
- f. Copy of Resolution of our Shareholders dated September 30, 2024 in relation to approving the Offer and other related matters;
- g. Copy of Resolution of the Board of Directors of our Company, dated January 11, 2025 in relation to approving the Draft Offer Document;
- h. Copy of Resolution of the Board of Directors of our Company, dated [●] in relation to approving the Offer Document;
- i. Copies of Annual Reports for the last three Fiscals, i.e., Fiscals 2024, 2023 and 2022;
- j. Report of the Statutory Auditor M/s. V.N. Purohit & Co, November 07, 2024, Chartered Accountants dated November 07, 2024 on the Restated Financial Statements for the 6 months period ended on September 30, 2024 and for the Fiscals 2024, 2023 and 2022 of our Company;
- k. Statement of Possible Tax Benefits dated November 08, 2024 issued by M/s. V.N. Purohit & Co, Chartered Accountants;
- l. Certificates dated November 08, 2024 issued by M/s. V.N. Purohit & Co, Chartered Accountants, the statutory auditors of our Company certifying the Key Performance Indicators set out in this Offer Document.

m. Consents of Promoter, Directors, Company Secretary and Compliance Officer, Chief Financial Officer, Senior Managerial Person, Statutory Auditors, Banker to the Company*, Legal Advisor to the Offer, Registrar to the Company, Lead Manager, Registrar to the Offer, Underwriter*, Market Maker* to act in their respective capacities;

* Will obtain before filing of Prospectus.

n. Due diligence certificate dated January 11, 2025 addressed to SEBI issued by the LM;

o. Draft Prospectus for listing of Equity Shares on SME Platform of BSE Limited.

p. Approval from BSE vide letter dated [●] to use the name of BSE in this Offer Document for listing of Equity Shares on the SME Platform of the BSE Limited

Any of the contracts or documents mentioned in this Draft Prospectus may be amended or modified at any time if so required in the interest of our Company or if required by the other parties, without reference to the shareholders subject to compliance of the provisions contained in the Companies Act, 2013 and other relevant statutes.

DECLARATION

I hereby certify and declare that all relevant provisions of the Companies Act, 1956 and Companies Act, 2013 and the rules, regulations and guidelines issued by the Government of India or the rules, regulations and guidelines issued by the SEBI, established under Section 3 of the SEBI Act, 1992 as the case may be, have been complied with and no statement, disclosures and undertakings made in this Draft Prospectus is contrary to the provisions of the Companies Act, 1956 and Companies Act, 2013, the SCRA, the SCRR, the SEBI Act or rules made or guidelines or regulations issued thereunder, as the case may be. I further certify that all the disclosures and statements made in this Draft Prospectus are true and correct.

SIGNED BY THE DIRECTOR OF OUR COMPANY

Sd/-

Sunil Menon

Managing Director

Date: January 11, 2025

Place: Mumbai

DECLARATION

I hereby certify and declare that all relevant provisions of the Companies Act, 1956 and Companies Act, 2013 and the rules, regulations and guidelines issued by the Government of India or the rules, regulations and guidelines issued by the SEBI, established under Section 3 of the SEBI Act, 1992 as the case may be, have been complied with and no statement, disclosures and undertakings made in this Draft Prospectus is contrary to the provisions of the Companies Act, 1956 and Companies Act, 2013, the SCRA, the SCRR, the SEBI Act or rules made or guidelines or regulations issued thereunder, as the case may be. I further certify that all the disclosures and statements made in this Draft Prospectus are true and correct.

SIGNED BY THE DIRECTOR OF OUR COMPANY

Sd/-

Gautam Makker

Non-Executive Director

Date: January 11, 2025

Place: Mumbai

DECLARATION

I hereby certify and declare that all relevant provisions of the Companies Act, 1956 and Companies Act, 2013 and the rules, regulations and guidelines issued by the Government of India or the rules, regulations and guidelines issued by the SEBI, established under Section 3 of the SEBI Act, 1992 as the case may be, have been complied with and no statement, disclosures and undertakings made in this Draft Prospectus is contrary to the provisions of the Companies Act, 1956 and Companies Act, 2013, the SCRA, the SCRR, the SEBI Act or rules made or guidelines or regulations issued thereunder, as the case may be. I further certify that all the disclosures and statements made in this Draft Prospectus are true and correct.

SIGNED BY THE DIRECTOR OF OUR COMPANY

Sd/-

Priyanka Moondra Rathi

Non-Executive Independent Director

Date: January 11, 2025

Place: Mumbai

DECLARATION

I hereby certify and declare that all relevant provisions of the Companies Act, 1956 and Companies Act, 2013 and the rules, regulations and guidelines issued by the Government of India or the rules, regulations and guidelines issued by the SEBI, established under Section 3 of the SEBI Act, 1992 as the case may be, have been complied with and no statement, disclosures and undertakings made in this Draft Prospectus is contrary to the provisions of the Companies Act, 1956 and Companies Act, 2013, the SCRA, the SCRR, the SEBI Act or rules made or guidelines or regulations issued thereunder, as the case may be. I further certify that all the disclosures and statements made in this Draft Prospectus are true and correct.

SIGNED BY THE DIRECTOR OF OUR COMPANY

Sd/-

Rajnish Prakash

Non-Executive Independent Director

Date: January 11, 2025

Place: Mumbai

DECLARATION

I hereby certify and declare that all relevant provisions of the Companies Act, 1956 and Companies Act, 2013 and the rules, regulations and guidelines issued by the Government of India or the rules, regulations and guidelines issued by the SEBI, established under Section 3 of the SEBI Act, 1992 as the case may be, have been complied with and no statement, disclosures and undertakings made in this Draft Prospectus is contrary to the provisions of the Companies Act, 1956 and Companies Act, 2013, the SCRA, the SCRR, the SEBI Act or rules made or guidelines or regulations issued thereunder, as the case may be. I further certify that all the disclosures and statements made in this Draft Prospectus are true and correct.

SIGNED BY THE CHIEF FINANCIAL OFFICER OF OUR COMPANY

Sd/-

Hitesh Birla

Chief Financial Officer

Date: January 11, 2025

Place: Mumbai

DECLARATION

I hereby certify and declare that all relevant provisions of the Companies Act, 1956 and Companies Act, 2013 and the rules, regulations and guidelines issued by the Government of India or the rules, regulations and guidelines issued by the SEBI, established under Section 3 of the SEBI Act, 1992 as the case may be, have been complied with and no statement, disclosures and undertakings made in this Draft Prospectus is contrary to the provisions of the Companies Act, 1956 and Companies Act, 2013, the SCRA, the SCRR, the SEBI Act or rules made or guidelines or regulations issued thereunder, as the case may be. I further certify that all the disclosures and statements made in this Draft Prospectus are true and correct.

SIGNED BY THE COMPANY SECRETARY AND COMPLIANCE OFFICER OF OUR COMPANY

Sd/-

Sonika Mehta

Company Secretary & Compliance Officer

Date: January 11, 2025

Place: Mumbai